

M3000 Motors for Hazardous Areas

ABB Low Voltage Motors M3000 Range



ABB



Making you more competitive

ABB has been manufacturing motors for over 100 years. Our products are designed to be reliable, efficient and cost effective, and we can supply motors for practically any application. A full range of services is available through our worldwide service organization, with the latest eBusiness systems providing round-the-clock access and easy ordering. The global reach of our central stock system enables us to deliver fast – no matter where our customers are located.

M3000 motors

Customized to fit the individual user's needs, the motors in ABB's M3000 range are designed to meet the tough demands of modern industry. All M3000 motors comply with eff1, the EU's highest efficiency class – which translates into cost savings and better environmental compatibility. Reliable, high quality products that are designed to last, ABB's M3000 motors offer years of trouble-free operation, even in critical environments.

Industrial^{IT}

As a key element of its business strategy, ABB has committed to a broad program of product development and positioning under the Industrial^{IT} umbrella. This initiative is geared towards increasing integration of ABB products as the 'building blocks' of larger solutions, while incorporating functionality that will allow multiple products to interact seamlessly as components of real-time automation and information systems.

Motors and generators represent one of the fundamental building blocks in the Industrial^{IT} architecture.

ABB (www.abb.com) is a global leader in power and automation technologies that enable utility and industrial customers to improve performance while lowering their environmental impact.

ABB has 155,000 employees in more than 100 countries.

Totally enclosed squirrel cage three phase motors for hazardous areas

Contents

General information about hazardous areas	4
--	---

General specification (applicable to all motors)	12
---	----

Flameproof EEx d - EEx de; 0.55 - 630 kW

Design	22	Variant codes	34
Technical data	26	Dimension drawings	38
Rating plates	33	Motors in brief	40

Increased safety EEx e; 0.25 - 350 kW

Design	42	Variant codes	56
Technical data	45	Dimension drawings	60
Rating plates	55	Motors in brief	64

Non-sparking EEx nA, E x nA, Ex N; 0.25 - 630 kW

Design	68	Variant codes	80
Technical data	71	Dimension drawings	84
Rating plates	79	Motors in brief	88

Dust ignition protection; 0.55 - 630 kW

Design	92	Variant codes	108
Technical data	95	Dimension drawings	112
Rating plates	107		

Frequency converter drive and hazardous areas	115
--	-----

Special applications

Motors for demanding applications	118
VIK Specification	119

Ordering information	126
-----------------------------	-----

LV Motors product range	124
--------------------------------	-----

Visit our web site	127
---------------------------	-----

ABB reserves the right to change the design, technical specification and dimensions, without prior notice.

Hazardous areas

Hazardous areas worldwide are classified by zone, according to the risk posed by explosive gas or dust in the atmosphere.

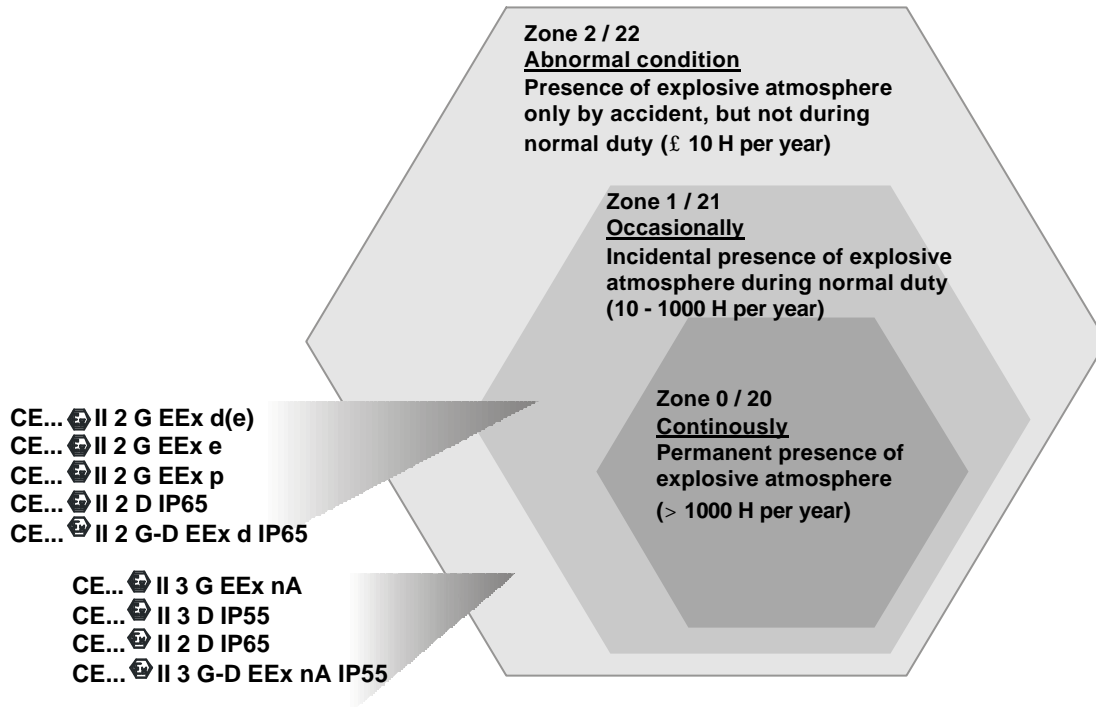

Classification of hazardous locations

The definition of areas according to the presence of atmosphere are set up in EN 1127-1 or IEC 60079-0.

Explosive atmosphere	Permanent presence	Incidental presence (normal operation conditions)	Accidental presence (abnormal operation conditions)
IEC (International) CENELEC (Europe)	Zone 0 (gas) Zone 20 (dust)	Zone 1 (gas) Zone 21 (dust)	Zone 2 (gas) Zone 22 (dust)
Note: In certain countries EEx d and EEx e motors are also used in Zone 2.			

July 2003; all equipment both electrical and non-electrical put on the market in hazardous areas shall comply with:

European Directive 94/9/EC (ATEX)

Motors in accordance with ATEX directive comply with:

- Low Voltage Directive 73/23/EEC amended by 93/68/EEC (Voltage supply less than 1000V)
- EMC Directive 89/336/EEC amended by 92/31/EEC and 93/68/EEC
- Machinery Directive 98/37/EEC (Certificate of Incorporation)

Key words of ATEX Directive:

- **Free movement in the EU territory** is ensured for any products complying with ATEX directive.
- **EHSRs:** Essential Health and Safety Requirements needed for products used in potentially explosive atmospheres with detailed demands of manufacturer.
- **1st of July 2003:** The European Union has decided not to extend the transition period for the new standard relating to equipment for use in potentially explosive atmospheres, ATEX, beyond 1st of July 2003.
- **Article 14:** Previous Directives 76/117/EEC, 79/198/EEC and 82/130/EEC will expire on 1st of July 2003.
- **All national standards** which are in conflict with the directive will be withdrawn.

In addition to the above, all ABB's motor production units are certified to ISO 9001 and ISO 14000.

Marking temperatures, gas groups and hazardous areas

To ensure equipment can be safely used in potentially explosive atmospheres, the hazardous areas where the equipment is installed must be known. Temperature class of equipment must be compared with the spontaneous ignition temperature of the gas mixtures concerned and its gas group must be known in specific cases (e.g. flame proof protection).

Categories or classification

The ATEX Directive has introduced the concept of "Categories" which is a way of expressing the capability of equipment respecting the EHSR needs for versus the Zone where the equipment is installed.

Category 1	according to Annex 1 of ATEX used in Zone 0 or Zone 20
Category 2	according to Annex 1 of ATEX used in Zone 1 or Zone 21
Category 3	according to Annex 1 of ATEX used in Zone 2 or Zone 22

Classification

	Category equipment	Inflammable substances	Level of protection	Fault protection	Comparison with present practice and IEC
Equipment group I (mines)	M1	Methane, dust	Very high level	2 types of protection or 2 independent faults	Group I
	M2	Methane, dust	High level	1 type of protection Normal operation	Group I
Equipment group II (surface)	1	Gas, vapours, mist, dust	Very high level	2 types of protection or 2 independent faults	Group II Z0 (gas) / Z20 (dust)
	2	Gas, vapours, mist, dust	High level	1 type of protection Habitual frequent malfunction	Group II Z1 (gas) / Z21 (dust)
	3	Gas, vapours, mist, dust	Normal	Required level of protection	Group II Z2 (gas) / Z22 (dust)

Temperature classes

Temperature class	Ignition temperature for the gas/vapor °C	Max. permitted temperature equipment °C
T1	> 450	450
T2	> 300 < 450	300
T3	> 200 < 300	200
T4	> 135 < 200	135
T5	> 100 < 135	100
T6	> 85 < 100	85

Grouping of electrical apparatus

Group I	Apparatus for coal mines susceptible to firedamp
Group II	Apparatus for explosive atmospheres other than mines; surface industries
IIA, IIB, IIC	Group II is subdivided for EEx d and EEx i -equipment according to the severity of the environment. IIC is the highest rating; a motor from one of the higher categories can also be used in a lower category environment.

Marking of equipment

CE marking CE 0081 II 2 G EEx d IIB T4

Identification of the notified body responsible for the approval. 0081 is the identification number of LCIE

The European Commission mark for Ex products

Motor grouping: **II** for surface industry (I for mines)

Equipment category: **2** allowed for Zone 1 or Zone 21 (**1** for Zone 0 or 20, **3** for Zone 2 or 22)

Atmosphere surrounding the motor: **G** for explosive gas (**D** for dust)

Additional marking specifying the type of protection of motor

Selection of products for hazardous areas

EN Standard for Group II: Gas environments

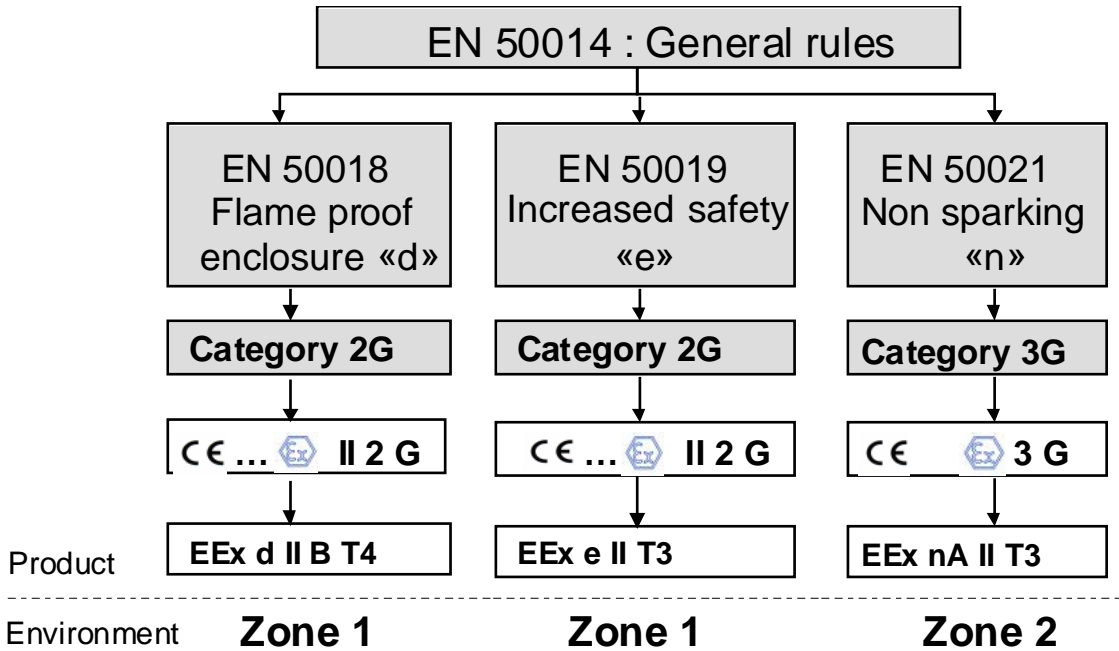

EN Standard for Group II: Dust environments

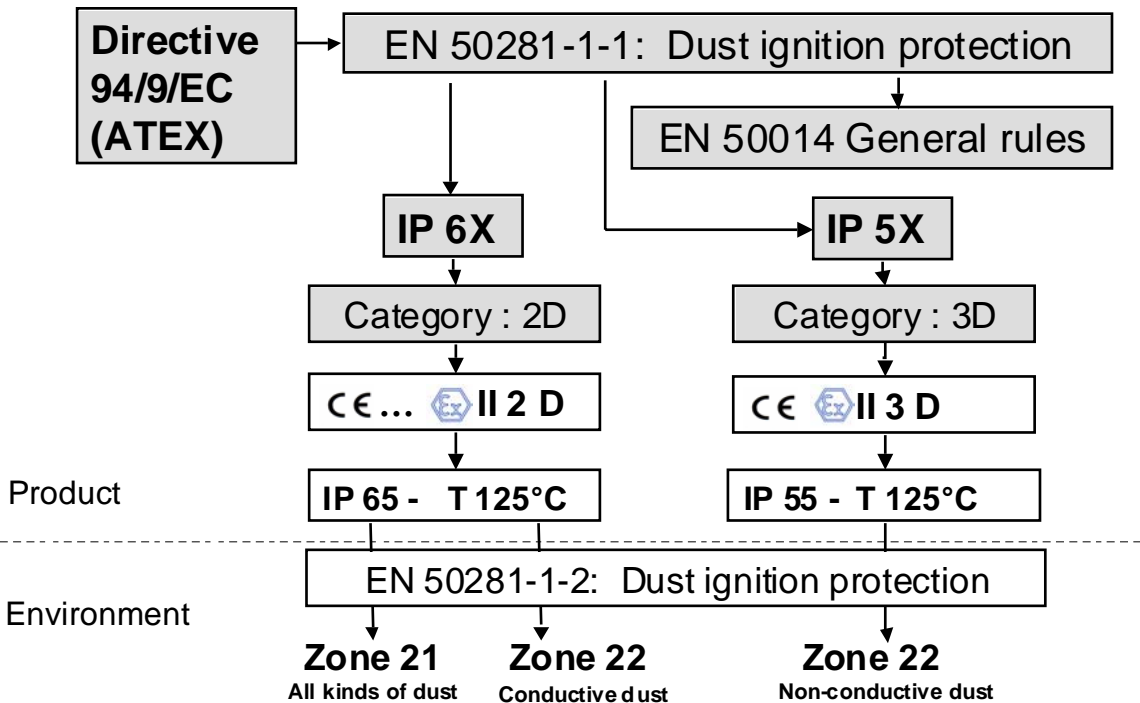

Dust Ignition protection in hazardous areas

Combustible dusts is hazardous as it can form potentially explosive atmospheres when dispersed in the air. Furthermore, layers of combustible dust may ignite and act as ignition source for an explosive atmosphere.

Hazardous areas with dust can be found in a variety of industries such as:

- agriculture
- chemicals
- plastics
- stock holding

Selection and installation of electrical equipment

To ensure equipment can be safely used in hazardous areas with dust, the following procedure should be considered before selecting a product:

1. Type of dust:

- Will a cloud of dust be present around the product or
- will a layer of dust build up on the product and if so, what will be the maximum thickness of the layer between two cleaning/maintenance periods?

2. Characteristics of the dust:

- Is the dust electrically conductive or non-conductive?

3. Ignition temperature of the dust:

- T_{Cr} : Ignition temperature of dust in a "cloud" or
- T_{5mm} : Ignition temperature of a 5 mm dust layer

Selection and installation of product: EN 50 281-1-2

Equipment category	Category 1 (Zone 21)	Category 2 (Zone 21 and conductive dust)	Category 3 (Zone 22 and non- conductive dust)
Minimum protection for equipment	not applicable	IP 6X	IP 5X

Marking temperature

Type of dust	Ignition temperature	Maximum surface temperature of motor	Marking temperature of equipment T°C
Cloud	T_{Cl}	$2/3 \times T_{Cl}$	$T^{\circ}C \leq 2/3 \times T_{Cl}$
Layer up to 5 mm	T_{5mm}	$T_{5mm} - 75 K$	$T^{\circ}C \leq (T_{5mm} - 75 K)$

T_{5mm} is the ignition temperature of 5 mm layer of dust
 Note: In case of dust layer above 5 mm; please consult ABB.

Substances (examples)

Dust	Wheat	Barley	Com	Turniprape	Sunflower	Sugar	Lignite	Sulphur
T_{Cl} (cloud)	420°C	450°C	400°C	480°C	490°C	350°C	450°C	190°C
T_{5mm} (5mm)	200°C	205°C	250°C	230°C	220°C	220°C	200°C	220°C

Marking of equipment

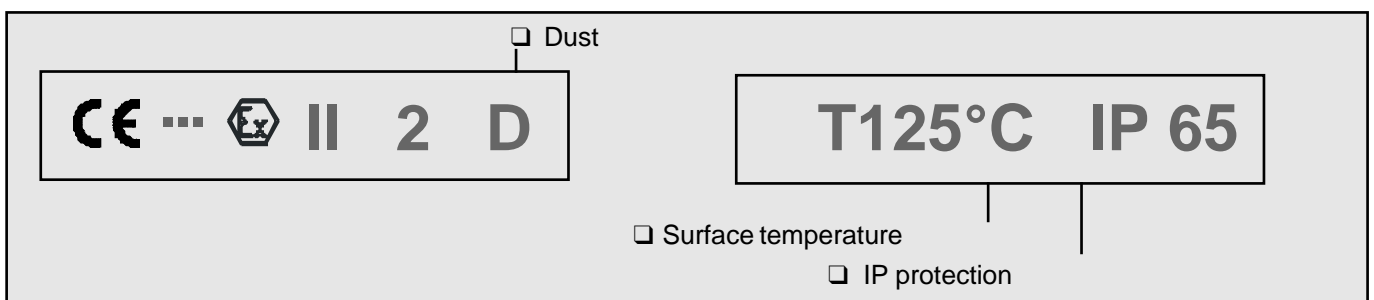

General about hazardous areas

Standards

Motors for hazardous areas comply with the following international standards:

- IEC publications 60079-0 (2000-06) and 60079-15 (2001-02); 61241-1-1 (1999-06)
- European standards (latest edition) EN 50014, EN 50016, EN 50018, EN 50019, EN 50021 and EN 50281-1-1
- British standards BS 5000 Part 16

Preamble

In hazardous areas, it is the utmost importance to ensure the safe use of electrical apparatus. To this end, many countries have regulations concerning both the design and use of such apparatus. These regulations are becoming increasingly harmonized within the framework of IEC recommendations and European Standards.

The hazard may be due to an explosive atmosphere composed of a mixture of gas, vapors or dusts with air. This chapter only deals with safety in explosive gas atmospheres for which European Standards exist.

Flameproof enclosure EEx d and EEx de

The motor enclosure shall be designed in such a way that no internal explosion can be transmitted to the explosive atmosphere surrounding the motor. The enclosure must withstand, without damage, any pressure levels caused by an internal explosion. The shape, length and gap of part assembly joints, at shaft opening, cable entries, etc., shall be designed to allow for throttling and cooling of hot gases escaping outside. The standards emphasize the impact of an explosive atmosphere (for instance, explosion pressure) over constructional requirements of such apparatus.

Work on assembly devices of enclosure component parts is only permitted using prescribed tools. Cable entries must meet the requirements of this type of protection.

The temperature of the motor's external enclosure should not exceed the self-ignition temperature of the explosive atmosphere of the installation area during normal

operation. For this reason, rated output depends on this rated maximum temperature for the considered area.

No motor device outside the flameproof enclosure (e.g., ventilation) shall be a potential source of sparks, arcs or dangerous overheating.

Variants combining two types of protection usually combine "d" and "e" protection. The most commonly used and recognized by the CENELEC European Standards is the EEx de variant. The motor is designed with an EEx d flameproof enclosure, while the terminal box features an EEx e increased safety protection. Such design combines the superior safety degree of the "d" type of protection with the less stringent electrical connection requirements of increased safety motors.

Motors featuring dual protection are seldom encountered - such as an increased safety motor with a flameproof enclosure designated EEx e + EEx d in European Standards.

Alleinschutz – thermistors as sole protection (optional)

The flameproof motors from ABB, frame sizes 80 to 400, have been certified for thermistors as sole protection against overload. This construction, "Alleinschutz", is available as an option, see variant codes.

"Alleinschutz" is a term that defines the certification of flameproof motor and protection device together. The certificate confirms that thermistors and relays will switch off the motor in case of overheating before the temperature of the motor's external enclosure exceeds the temperature marking stamped on the rating plate.

Each motor ordered with thermistors as sole protection

will be tested, with locked rotor, up to the point where the thermistors trigger the relay to turn off the motor. At the triggering temperature, the motor has to be within the certified temperature class.

The relay is included in the certificate, which means that only approved relays can be used for "Alleinschutz".

Please note that sizes 315 to 400 require special technical solutions, consult ABB.

Increased safety design, EEx e

The design of this motor type prevents the occurrence of sparks, arcs or hot spots in service (including starting and locked rotor situation), that could reach the self-ignition temperature of the surrounding, potentially explosive atmosphere, in all inner and outer parts of the machine.

This is ensured by applying constructional or dimensional provisions that mainly concern:

- specified minimum values for creepage distances and clearances
- use of tracking-proof isolating materials
- suppression of sharp angles where static electrical loads could build-up
- ensuring electrical and mechanical assemblies are tightly secured
- minimum backlash values between stationary and rotating parts (e.g., air gap, ventilation, etc.)
- temperature-rise limits, taking into account locked rotor, normal operation, accidental mechanical stalling of machine under the most adverse thermal conditions, i.e. when thermal equilibrium of machine is reached while in service.

Temperature rise limits are to be considered for two operating aspects; one for normal operating conditions and the other under accidental stalling conditions.

Temperature rise limits under normal operating conditions

The expected electrical lifespan of a motor depends on its temperature rise for a given insulation class, and on the motor winding temperature, in operation, which is not homogeneous with hot spots appearing.

For these reasons, a safety margin of 10 K is allowed for between windings temperature rise at rated output, as

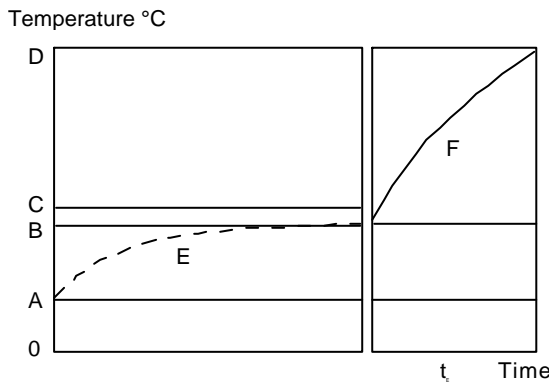

Figure 1.

- O = temperature 0°C
- A = Max. ambient temperature, reference 40°C
- B = Temperature at rated load
- C = Max temperature as permitted by the insul. class
- D = Max limit temperature as set by the nature of the potentially explosive atmosphere
- E = Temperature-rise curve of motor at rated output
- F = Temp. rise curve under stalled rotor conditions
- t_E = stalled rotor time

measured by the change of resistance method, and the maximum temperature rise permitted by the winding insulation class.

Temperature rise limits during short circuit under accidental stalling conditions

Should the machine stall while in operation, a short-circuit current nearly equal to the starting current will develop, and stator and rotor winding temperatures will rise rapidly (see figure 1).

To prevent this temperature value from exceeding the temperature level below which the apparatus should not cause the spontaneous ignition of an explosive atmosphere, protection devices must trip within a specified time (t_E). This tripping time depends on the short-circuit current level or the short-circuit current to rated current ratio (I_A/I_N). Figures 2 and 3 show, for commonly used protection devices, the limiting ratio between short-circuit current inrush I_A/I_N and rotor stalling time t_E , according to the EN and VIK.

This type of protection is inappropriate for commutator machines or brake-motors which, by principle, are capable of producing arcs, sparks or hot spots.

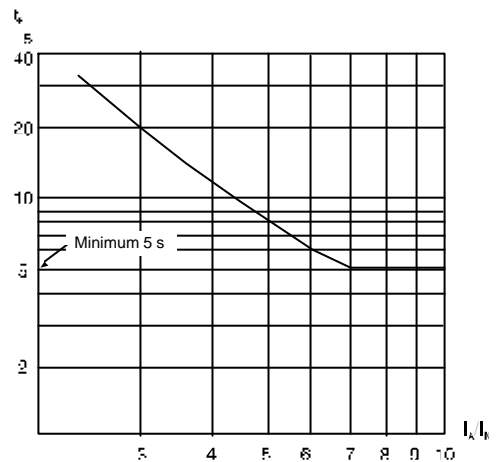

Figure 2. Min. value of time t_E as a function of I_A/I_N acc. to EN 50019.

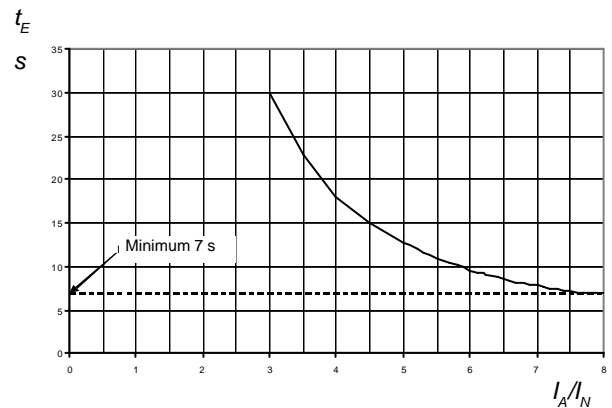

Figure 3. Min. value of time t_E as a function of I_A/I_N acc. to VIK.

Non-sparking design, EEx nA, Ex nA, Ex N

This type of protection is allowed to be used in the hazardous area corresponding to zone 2.

This design is also known as 'Non-sparking' type as the motor must be designed in such a way that no sparks can occur in normal operation, and used within the ratings specified by the manufacturer, which excludes thermal requirements due to starting or accidental stalling.

Yet, EHRS's (Essential Health and Safety Requirements) stated in ATEX Directive for products installed in zone 2 have introduced new requirements on the motor design compared to previous technical report IEC 79-15 (1987) used for Zone 2. These new requirements make the motor safer against the risk of spark during the start-up.

However, along with the ATEX -directive, the national

standards will be withdrawn and supersided by the ATEX directive 94/9/EC and the EN standards. Thus the new British standard for non-sparking is BS-EN 50021.

EEx nA motors are not flameproof motors. They have no flamepath, and thus the enclosure groups A, B and C have no relevance. The letter "A" stands for non-sparking equipment according to EN 50021.

After 1st of July, 2003 it will not be allowed to put on the market any motor according to IEC 79-15 in hazardous area corresponding to zone 2 in Europe.

The requirements of IEC 60079-15 are identical to the requirements of EN 50021, which proves that although CENELEC and IEC operate at two different levels, their action has a strong mutual impact in the electrotechnical field around the world.

Dual certification

EEx nA motors in cast iron frame can also be used for Dust -applications. Following combinations are possible:

CI sizes 71..315	EEx nA II T3 for zone 2	DIP T125°C, IP55 for zone 22
CI sizes 160..315	EEx nA II T3 for zone 2	DIP T125°C, IP65 for zone 21

These features are possible due to the IP protection. The gases penetrate this protection, and thus the inside surface temperature class is T3 (200°C). The ingress of dust, however, is prevented and the dust determines the outside surface temperature class: T 125°C.

Testing and certificates

Motors for hazardous areas have to be officially approved by a recognized test organization, authorized to issue test certificates, to ensure compliance with standards for this type of equipment.

Motors are defined and classified according to the potentially explosive atmospheres present at the installation site, described on page 4.

Depending on the nature of the atmosphere, it is the responsibility of the user to determine which group and which maximum surface temperature should be specified for the motor installation.

The motors are rated and certified for ambient temperature between -20°C and +40°C according to standards.

For ambient temperature below -20°C and above +40°C certificates are available for some motors, please contact ABB.

ABB's motors conform to the stringent standards set by CENELEC (European Committee for Electrotechnical Standardization), and are approved by testing laboratories (ExNB: Notified Body). The EU member countries have a common standard for motors for hazardous environments; Euronorm

EN 50014: General rules

EN 50016: Pressurised motor EEx p

EN 50018: Flame proof motor EEx d

EN 50019: Increased safety motor EEx e

EN 50021: Non-sparking motor EEx nA



EN 500281-1: Dust ignition proof motor DIP

Motors can be certified by any of the Notified Bodies "ExNB" of EU member countries. These motors are therefore acceptable in all EU countries and most other countries.

General Technical Specification

Mechanical and electrical design

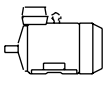
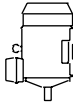
Mounting arrangements

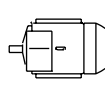
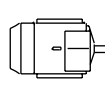
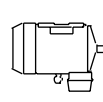
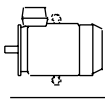
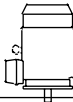
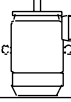
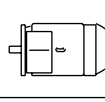
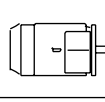
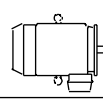
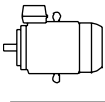
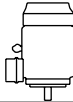
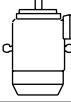
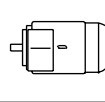
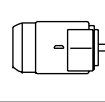
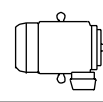
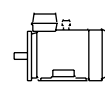
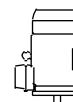
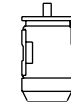
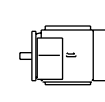
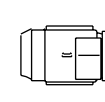
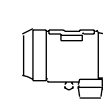
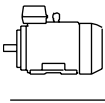
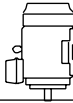
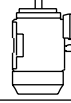
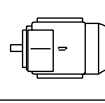
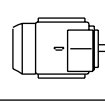
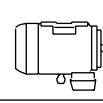
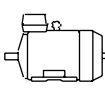
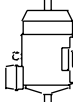
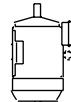
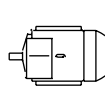
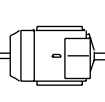
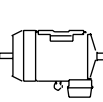
	Codel/Codell						Product code pos. 12
Foot-mounted motor.	IM B3 IM1001	IM V5 IM1011	IM V6 IM1031	IM B6 IM1051	IM B7 IM1061	IM B8 IM1071	A = foot-mounted, term.box top R = foot-mounted, term.box RHS L = foot-mounted, term.box LHS
							
Flange-mounted motor, large flange	IM B5 IM3001	IM V1 IM3011	IM V3 IM3031	*) IM3051	*) IM3061	*) IM3071	B = flange mounted, large flange
							
Flange-mounted motor, small flange	IM B14 IM3601	IM V18 IM3611	IM V19 IM3631	*) IM3651	*) IM3661	*) IM3671	C = flange mounted, small flange
							
Foot- and flange-mounted motor with feet, large flange	IM B35 IM2001	IM V15 IM2011	IM V36 IM2031	*) IM2051	*) IM2061	*) IM2071	H = foot/flange-mounted, term.box top S = foot/flange-mounted, term.box RHS T = foot/flange-mounted, term.box LHS
							
Foot- and flange-mounted motor with feet, small flange	IM B34 IM2101	IM2111	IM2131	IM2151	IM2161	IM2171	J = foot/flange-mounted, small flange
							
Foot-mounted motor, shaft with free extensions	IM1002	IM1012	IM1032	IM1052	IM1062	IM1072	
							

*) Not stated in IEC 60034-7.

Voltage and frequency

The table values for output, speed, efficiency, power factor, starting torque and starting current apply at the rated voltage and frequency. These values will be affected if the supply voltage or frequency deviate from the rated values.

The motors can operate continuously at the rated output, with a long-term voltage deviation of 5 % from the

specified value or range of values, and at the rated frequency without exceeding the temperature class stamped on the rating plate. The temperature rise of the winding may increase by 10 K, but without exceeding the insulation temperature class stamped on the rating plate. Voltage deviations of up to 10 % are permissible for short periods only.

Protection against corrosion

Special attention has been paid to the finish of ABB's motors. All parts are treated by the method most appropriate to each material, giving reliable anti-corrosion protection under severe environmental conditions.

The color is blue, Munsel color code: 8B, 4.5/3.25 (NCS4822-B05G the closest shade in other standards). Specific details of paint types are available on request.

Drain holes

Non-sparking, Increased Safety and dust ignition proof motors are fitted with drain holes and plugs according to the table below.

Flameproof motors are not as standard fitted with drain holes, but can be on request, see variant codes.

Type of protection	Frame material	Frame size	Drain holes
Non-sparking, increased safety	Aluminium	90-250	closed
	Cast iron	71 - 132	optional
		160 - 400	open
Flameproof	Cast iron	80-400	not included, optional
Dust ignition proof	Aluminium	90-250	not included
Dust ignition proof, category 2D	Cast iron	80-315	not included, optional
Dust ignition proof, category 3D	Cast iron	80-132	optional
		160-400	open

Motor sizes 71 to 250:

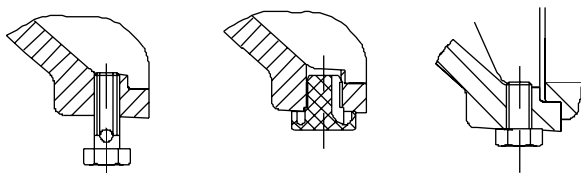

Motor sizes 160 to 400:

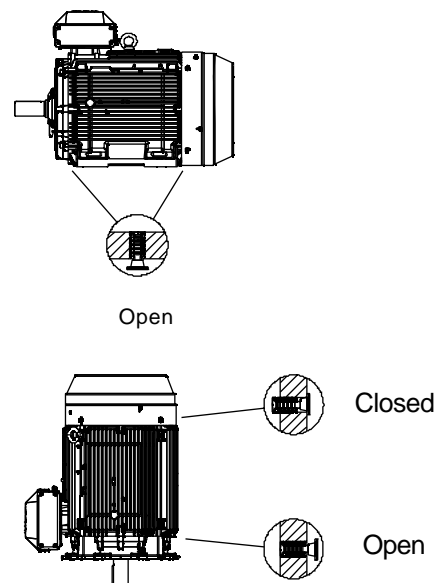

Bearings

ABB policy is to have reliability as a vital issue in bearing design as well as in bearing lubrication systems. That is why we, as standard, follow the L1 -principle (meaning that 99 per cent of the bearings achieve or exceed the calculated bearing lifetime). The lubrication intervals can also be calculated according to L10 -principle which means that 90 per cent of the motors are sure to make the interval time. L10 -values, which are normally doubled compare to L1 -values, are available from ABB at request.

Motors with permanently greased bearings

Cast iron motors up to frame size 132 and aluminium motors up to frame size 180 are normally fitted with permanently greased bearings of type Z or 2Z. The exception is DIP motors with aluminium frame sizes 90-250, which are fitted with 2RS bearings because higher protection is required.

Guidelines for bearing life time acc. to L₁ principle:

Aluminium motors

- 2 and 2/4 pole motors, 10 000 - 20 000 duty hours ¹⁾
- 4 to 8 pole motors, 20 000 - 40 000 duty hours ¹⁾

Cast iron motors

- 2 and 2/4 pole motors, 20 000 duty hours ¹⁾
- 4 to 8 pole motors, 40 000 duty hours ¹⁾

¹⁾depending on application and load conditions.

Lubrication

Lubricate the motor when operational. If a grease outlet plug is fitted, temporarily remove when lubricating, or permanently with auto lubrication. If the motor is fitted with a lubrication plate, use values given, or use the values given in the table beside. These values are according to L1 -principle, which is the ABB standard for all motors.

The effectiveness of the motor lubrication should be checked by measuring the surface temperature of bearing endshields during normal operating conditions. If the measured temperature is +80°C or above, the relubrication intervals must be shortened; i.e. the relubrication interval should be halved for every 15K increase in bearing temperature. If this is not possible ABB recommends the use of lubricants suitable for high operating temperature conditions. These lubricants allow a normal relubrication interval and 15K increase in bearing temperature conditions.

Formula to change the L1 values roughly to L10 values:

$$L10 = 2.5 \times L1$$

Motors fitted with grease nipples

Cast iron motors from frame size 160 and aluminium motors from frame size 200 and above (DIP motors with aluminium frame excluded), are as standard fitted with regreasable bearings. Cast iron motors sizes 160 to 250 are also available as stocked option with bearings greased for life.

Lubricate the motor when operating.

For motors with lubrication systems we recommend not to exceed lubrication interval of two years in any case.

Lubrication intervals acc. to L1 principle

Frame size	Amount of grease g	3600 r/min	3000 r/min	1800 r/min	1500 r/min	1000 r/min	500-750 r/min
------------	--------------------	------------	------------	------------	------------	------------	---------------

Ball bearings: lubrication intervals in duty hours

112	12	10700	13000	18100	20900	25200	27700
132	15	9300	11300	17300	19000	22900	26400
160	26	7000	9300	14300	17300	20900	24000
180	30	5800	8100	13600	15700	19900	22900
200	40	3800	5800	10700	13000	17300	20900
225	46	3100	5000	10200	12400	16500	19900
250	60	2500	4000	9000	11500	15000	18000
280	67	2000	3500	8000	10500	14000	17000
315	90	2000	3500	6500	8500	12500	16000
355	120	1200	2000	4200	6000	10000	13000
400	120	1200	2000	4200	6000	10000	13000

Roller bearings: lubrication intervals in duty hours

160	26	4600	6400	11300	14300	18100	21900
180	30	3400	5300	10700	13000	16500	19900
200	40	2100	3800	8100	10700	15000	18100
225	46	1500	3000	7300	9800	13600	17300
250	60	1300	2200	6300	8500	13000	16000
280	67	1000	2000	5700	7600	12000	15000
315	90	1000	2000	4000	6000	9000	13000
355	120	400	1000	2300	4000	7000	10000
400	120	400	1000	2300	4000	7000	10000

Standard bearing types

The motors are normally fitted with single-row deep groove ball bearings as listed in the table below.

For special bearings, please see the variant codes.

Motor size	Poles	Flameproof motors		Increased safety motors		Non-sparking motors	
		Bearing D-end	Bearing N-end	Bearing D-end	Bearing N-end	Bearing D-end	Bearing N-end
Aluminium motors							
90	2-8			6305-2Z/C3	6204-2Z/C3	6305-2Z/C3	6204-2Z/C3
100	2-8			6306-2Z/C3	6205-2Z/C3	6306-2Z/C3	6205-2Z/C3
112	2-8			6206-2Z/C3	6205-2Z/C3	6206-2Z/C3	6205-2Z/C3
132	2-8			6208-2Z/C3	6206-2Z/C3	6208-2Z/C3	6206-2Z/C3
160	2-8			6309-2Z/C3	6209-2Z/C3	6309-2Z/C3	6209-2Z/C3
180	2-8			6310-2Z/C3	6209-2Z/C3	6310-2Z/C3	6209-2Z/C3
200	2-8			6312/C3	6210/C3	6312/C3	6210/C3
225	2-8			6313/C3	6212/C3	6313/C3	6212/C3
250	2-8			6315/C3	6213/C3	6315/C3	6213/C3
Cast iron motors							
71	2-8					6202-2RS/C3	6202-2RS/C3
80	2-8	6204-2Z/C3	6204-2Z/C3	6204-2Z/C3	6204-2Z/C3	6204-2RS/C3	6204-2RS/C3
90	2-8	6205-2Z/C3	6205-2Z/C3	6205-2Z/C3	6205-2Z/C3	6205-2RS/C3	6205-2RS/C3
100	2-8	6206-2Z/C3	6206-2Z/C3	6206-2Z/C3	6206-2Z/C3	6206-2RS/C3	6206-2RS/C3
112	2-8	6206-2Z/C3	6206-2Z/C3	6206-2Z/C3	6206-2Z/C3	6207-2RS/C3	6206-2RS/C3
132	2-8	6208-2Z/C3	6208-2Z/C3	6208-2Z/C3	6208-2Z/C3	6208-2RS/C3	6207-2RS/C3
160	2	6309M/C3 ¹⁾	6309M/C3 ¹⁾	6309M/C3	6309M/C3	6309M/C3 ¹⁾	6309M/C3 ¹⁾
	4-8	6309/C3 ¹⁾	6309/C3 ¹⁾	6309/C3	6309/C3	6309/C3 ¹⁾	6309/C3 ¹⁾
180	2	6310M/C3 ¹⁾	6309M/C3 ¹⁾	6310M/C3	6309M/C3	6310M/C3 ¹⁾	6309M/C3 ¹⁾
	4-8	6310/C3 ¹⁾	6309/C3 ¹⁾	6310/C3	6309/C3	6310/C3 ¹⁾	6309/C3 ¹⁾
200	2	6312M/C3 ¹⁾	6310M/C3 ¹⁾	6312M/C3	6310M/C3	6312M/C3 ¹⁾	6310M/C3 ¹⁾
	4-8	6312/C3 ¹⁾	6310/C3 ¹⁾	6312/C3	6310/C3	6312/C3 ¹⁾	6310/C3 ¹⁾
225	2	6313M/C3 ¹⁾	6312M/C3 ¹⁾	6313M/C3	6312M/C3	6313M/C3 ¹⁾	6312M/C3 ¹⁾
	4-8	6313/C3 ¹⁾	6312/C3 ¹⁾	6313/C3	6312/C3	6313/C3 ¹⁾	6312/C3 ¹⁾
250	2	6315M/C3 ¹⁾	6313M/C3 ¹⁾	6315M/C3	6313M/C3	6315M/C3 ¹⁾	6313M/C3 ¹⁾
	4-8	6315/C3 ¹⁾	6313/C3 ¹⁾	6315/C3	6313/C3	6315/C3 ¹⁾	6313/C3 ¹⁾
280	2	6316/C3	6316/C3	6316/C3	6316/C3	6316/C3	6316/C3
	4-8	6316/C3	6316/C3	6316/C3	6316/C3	6316/C3	6316/C3
315	2	6316/C3	6316/C3	6316/C3	6316/C3	6316/C3	6316/C3
	4-8	6319/C3	6316/C3	6319/C3	6316/C3	6319/C3	6316/C3
355	2	6319M/C4	6319M/C4	6319M/C4	6319M/C4	6319M/C4	6319M/C4
	4-8	6322/C3	6319/C3	6322/C3	6319/C3	6322/C3	6319/C3
400	2	6319M/C4	6319M/C4	6319M/C4	6319M/C4	6319M/C4	6319M/C4
	4-8	6322/C3	6319/C3	6322/C3	6319/C3	6322/C3	6319/C3

¹⁾ Motors also available as standard with bearings greased for life.

Motor size	Poles	Dust ignition protection Category 2 D		Category 3 D	
		Bearing D-end	Bearing N-end	Bearing D-end	Bearing N-end
Aluminium motors					
90	2-8	63052RSC3	62042RSC3	63052RSC3	62042RSC3
100	2-8	63062RSC3	62052RSC3	63062RSC3	62052RSC3
112	2-8	62062RSC3	62052RSC3	62062RSC3	62052RSC3
132	2-8	62082RSC3	62062RSC3	62082RSC3	62062RSC3
160	2-8	63092RSC3	62092RSC3	63092RSC3	62092RSC3
180	2-8	63102RSC3	62092RSC3	63102RSC3	62092RSC3
200	2-8	62132RSC3	62112RSC3	62132RSC3	62112RSC3
225	2-8	62142RSC3	62142RSC3	62142RSC3	62142RSC3
250	2-8	62142RSC3	62142RSC3	62142RSC3	62142RSC3
Cast iron motors					
71	2-8	–	–	6202-2RS/C3	6202-2RS/C3
80	2-8	6204-2RSC3	6202-2RSC3	6204-2RS/C3	6204-2RS/C3
90	2-8	6205-2RSC3	6205-2RSC3	6205-2RS/C3	6205-2RS/C3
100	2-8	6206-2RSC3	6206-2RSC3	6206-2RS/C3	6206-2RS/C3
112	2-8	6206-2RSC3	6206-2RSC3	6207-2RS/C3	6207-2RS/C3
132	2-8	6208-2RSC3	6208-2RSC3	6208-2RS/C3	6208-2RS/C3
160	2	6309M/C3 ¹⁾	6309M/C3 ¹⁾	6309M/C3 ¹⁾	6309M/C3 ¹⁾
	4-8	6309/C3 ¹⁾	6309/C3 ¹⁾	6309/C3 ¹⁾	6309/C3 ¹⁾
180	2	6310M/C3 ¹⁾	6309M/C3 ¹⁾	6310M/C3 ¹⁾	6309M/C3 ¹⁾
	4-8	6310/C3 ¹⁾	6309/C3 ¹⁾	6310/C3 ¹⁾	6309/C3 ¹⁾
200	2	6312M/C3 ¹⁾	6310M/C3 ¹⁾	6312M/C3 ¹⁾	6310M/C3 ¹⁾
	4-8	6312/C3 ¹⁾	6310/C3 ¹⁾	6312/C3 ¹⁾	6310/C3 ¹⁾
225	2	6313M/C3 ¹⁾	6312M/C3 ¹⁾	6313M/C3 ¹⁾	6312M/C3 ¹⁾
	4-8	6313/C3 ¹⁾	6312/C3 ¹⁾	6313/C3 ¹⁾	6312/C3 ¹⁾
250	2	6315M/C3 ¹⁾	6313M/C3 ¹⁾	6315M/C3 ¹⁾	6313M/C3 ¹⁾
	4-8	6315/C3 ¹⁾	6313/C3 ¹⁾	6315/C3 ¹⁾	6313/C3 ¹⁾
280	2	6316/C3	6316/C3	6316/C3	6316/C3
	4-8	6316/C3	6316/C3	6316/C3	6316/C3
315	2	6316/C3	6316/C3	6316/C3	6316/C3
	4-8	6319/C3	6316/C3	6319/C3	6316/C3
355	2	6319M/C4	6319M/C4	6319M/C4	6319M/C4
	4-8	6322/C3	6319/C3	6322/C3	6319/C3
400	2	6319M/C4	6319M/C4	6319M/C4	6319M/C4
	4-8	6322/C3	6319/C3	6322/C3	6319/C3

¹⁾ Motors also available as standard with bearings greased for life.

Transport locking

Motors with roller bearings or an angular contact ball bearing are fitted with a transport lock before despatch to prevent damage to the bearings during transport. When the transport lock is fitted, the motor is provided with a warning sign.

Locking may also be fitted in other cases where the transport handling could be damaging.

Axially-locked bearings

The table shows which motors are axially locked in the bearing seat, by an inner bearing cover.

See also variant code 042.

Aluminium motors

Motor size	Foot-mounted motors	Flange-mounted motors	
		Large flange	Small flange
90-100	D-end	D-end	D-end
112-132	¹⁾	D-end	D-end
160-180	D-end	D-end	
200-250	N-end	N-end	

¹⁾ A spring washer at the N-end locks the rotor at the D-end.
DIP motors locked at D-end

Cast iron motors

Motor size	Foot-mounted motors	Flange-mounted motors	
		Non-sparking and Increased safety motors:	
71-132	On request	On request	
160-180	D-end	D-end	
200-400	D-end	D-end	
Flameproof motors:			
80-400	D-end	D-end	

Permissible loadings on the shaft end

The following tables give the permissible radial and axial forces in Newton, assuming only radial or axial force is applied. Permissible loads of simultaneous radial and axial forces will be supplied on request.

The bearing life, L_{10} , is calculated according to ISO 281 standard theory, which also takes the purity of the grease into consideration. An adequate lubrication is a necessary prerequisite for the table below.

The values are based on normal conditions at 50 Hz. At 60 Hz the values must be reduced by 10 %. For two-speed motors, the values must be based on the higher speed.

Motors are foot-mounted IM B3 version with force directed sideways. In some cases the strength of the shaft affects the permissible forces.

If flameproof motors EEx d or EEx de sizes 160 and above are subject to high radial forces (e.g. belt drive) they should be fitted with roller bearings. Permissible radial forces for IIB and IIC are available from ABB on request.

Please note that motors type EEx d or EEx de IIB and IIC in size 250 and above with roller bearings require detailed information about power transmission; please consult ABB.

Aluminium Motors

Permissible axial force FA and radial force FR (acc. to L₁₀-principle)

Motor size	No of poles	Rotor weight FGR N	Ball bearings Basic design with deep groove ball bearings				Alternative design with 63-series bearings				Roller bearings Alternative design with roller bearings			
			25,000 hrs		40,000 hrs		25,000 hrs		40,000 hrs		25,000 hrs		40,000 hrs	
			FA N	FR N	FA N	FR N	FA N	FR N	FA N	FR N	FA N	FR N	FA N	FR N
90 ^{2) 3)}	2		1835	1200	1625	1200								
	4		2055	1200	1805	1200								
	6		2210	1200	1930	1200								
	8		2285	1200	1985	1200								
100 ^{2) 3)}	2		2370	1800	2100	1800								
	4		2645	1800	2330	1800								
	6		2830	1800	2480	1800								
	8		2925	1800	2555	1800								
112 M ²⁾	2	64	1500	1420	1320	1280	2230	1700	1970	1700				
	4	84	1600	1410	1390	1250	2410	1700	2110	1700				
	6	85	1730	1510	1500	1340	2590	1700	2260	1700				
	8	89	1750	1530	1510	1360	2680	1700	2320	1700				
112 MB ²⁾	2	85	1530	1470	1340	1330	2250	1700	1990	1700				
	4	106	1600	1430	1390	1260	2410	1700	2110	1700				
	6	107	1720	1520	1490	1340	2590	1700	2250	1700				
	8	107	1760	1560	1520	1370	2680	1700	2320	1700				
132 SA ²⁾	2	89	2570	2360	2260	2140	3460	3180	3070	2870				
132 SB ²⁾	2	101	2570	2360	2260	2130	3460	3170	3070	2870				
132 SC ²⁾	2	143	2520	2430	2210	2200	3410	3200	3020	2960				
132 S ²⁾	4	138	2770	2440	2440	2180	3770	3200	3320	2990				
132 M ²⁾	4	160	2750	2410	2420	2150	3750	3200	3290	2950				
132 MB ²⁾	4	211	2680	2440	2340	2170	3670	3200	3220	3000				
132 S ²⁾	6	140	2950	2560	2580	2270	4020	3200	3520	3120				
132 MA ²⁾	6	165	2940	2530	2570	2250	4010	3200	3500	3100				
132 MB ²⁾	6	197	2910	2500	2550	2220	3980	3200	3480	3070				
132 MC ²⁾	6	214	2830	2510	2460	2220	3900	3200	3400	3090				
132 S ²⁾	8	165	3040	2630	2650	2330	4150	3200	3610	3200				
132 M ²⁾	8	197	3020	2590	2630	2300	4130	3200	3590	3170				
132 MB ²⁾	8	214	2940	2630	2560	2330	4050	3200	3520	3200				
160 MA ²⁾	2	211	4730	3500	4220	3500					3050	3500	2720	3500
	8	280	5240	3500	4640	3500					3400	3500	3100	3500
160 M ²⁾	2	227	4730	3500	4220	3500					3060	3500	2710	3500
	4	270	5230	3500	4640	3500					3370	3500	3000	3500
	6	320	5220	3500	4630	3500					3330	3500	2970	3500
	8	320	5220	3500	4630	3500					3330	3500	2970	3500
160 L ²⁾	2	277	5240	3500	4650	3500					3350	3500	2980	3500
	4	338	5220	3500	4630	3500					3330	3500	2970	3500
	6	374	5050	3500	4470	3500					3150	3500	2760	3500
	8	445	4720	3500	4740	3500					3590	3500	3170	3500
160 LB ²⁾	2	296	5240	3500	4650	3500					3350	3500	2980	3500
	4	374	5050	3500	4470	3500					3150	3500	2760	3500
	6	445	4720	3500	4740	3500					3590	3500	3170	3500
	8	445	4720	3500	4740	3500					3590	3500	3170	3500
180 M ²⁾	2	332	4660	5550	4250	5110					2820	5900	2420	5900
	4	451	4950	5710	4500	5200					3120	5900	2660	5900
180 L ²⁾	4	522	4870	5670	4390	5150					3030	5900	2560	5900
	6	571	5200	5900	4710	5500					3360	5900	2870	5900
	8	561	5370	5900	4850	5570					3540	5900	3010	5900
	8	561	5370	5900	4850	5570					3540	5900	3010	5900
180 LB ²⁾	2	382	4660	5550	4250	5110					2820	5900	2420	5900
	4	602	4870	5670	4390	5150					3030	5900	2560	5900
	6	610	5200	5900	4710	5500					3360	5900	2870	5900
	8	606	5370	5900	4850	5570					3540	5900	3010	5900

1) Method of mounting	Direction of force	Permissible axial force
Horizontal	Horizontal	FA acc. to table
Vertical	Downwards	FA – rotor weight FGR ²⁾
Vertical	Upwards	FA + rotor weight FGR ²⁾

2) For motor sizes 90 to 180, axial tension in the direction of the shaft is assumed. The specified values take the weight of the rotor and the effects of the spring washer at the N-end into consideration.

3) Basic design with 63-series bearings at the D-end.

Permissible axial force FA and radial force FR - continued

Motor size	No of poles	Rotor weight FGR N	Ball bearings				Roller bearings					
			Basic design with deep groove ball bearings				Alternative design with 63-series bearings					
			25,000 hrs		40,000 hrs		25,000 hrs		40,000 hrs			
FA N	FR N	FA N	FR N	FA N	FR N	FA N	FR N	FA N	FR N			
200 MLB ³⁾	2	559	1570	4060	1340	3590			1570	7790	1340	7790
	4	746	1670	4360	1400	3810			1670	7790	1400	7790
	6	785	1800	4540	1510	3940			1800	7790	1510	7790
	8	883	1780	4670	1470	4030			1780	7790	1470	7790
200 MLC ³⁾	2	579	1560	4050	1330	3590			1560	7790	1330	7790
	6	873	1670	4430	1380	3820			1670	7790	1380	7790
	8	893	2490	4930	2130	4320			2490	8300	2130	8300
225 SMA ³⁾	4	746	2490	4930	2130	4320			2490	8300	2130	8300
	8	893	2790	5420	2380	4700			2790	8300	2380	8300
225 SMB ³⁾	2	697	2200	4530	1890	4010			2200	8900	1890	8900
	4	814	2440	4870	2070	4260			2440	8300	2070	8300
	6	691	2570	5080	2170	4400			2570	8300	2170	8300
	8	971	2720	5350	2310	4630			2720	8300	2310	8300
225 SMC ³⁾	2	765	2170	4510	1860	3990			2170	8900	1860	8900
	4	942	2360	4840	1980	4230			2360	8300	1980	8300
	6	1090	2465	5020	2065	4340			2460	8300	2060	8300
	8	1110	2580	5230	2160	4500			2580	8300	2160	8300
250 SMA ³⁾	2	824	2620	5620	2250	4980			2620	9100	2250	9100
	4	971	2970	6200	2530	5440			2970	11550	2530	11550
	6	1235	3100	6430	2630	5590			3100	11550	2630	11550
	8	1255	3230	6650	2740	5760			3230	11550	2740	11550
250 SMB ³⁾	2	942	2570	5610	2210	4960			2570	9100	2210	9100
	4	1175	2860	6140	2410	5380			2860	11550	2410	11550
	6	1430	2985	6400	2500	5560			2980	11550	2500	11550
	8	1450	3080	6590	2570	5700			3080	11550	2570	11550

Method of mounting	Direction of force	Permissible axial force
Horizontal	Horizontal	FA acc. to table
Vertical	Downwards	FA – rotor weight FGR ²⁾
Vertical	Upwards	FA + rotor weight FGR ²⁾

- ²⁾ For motor sizes 90 to 180, axial tension in the direction of the shaft is assumed. The specified values take the weight of the rotor and the effects of the spring washer at the N-end into consideration.
- ³⁾ Basic design with 63-series bearings at the D-end.

Cast iron Motors

Permissible radial forces (acc. to L₁₀-principle) - Motor sizes 71 - 132 *)

Non-sparking, Increased safety, dust ignition proof

Motor size	Poles	Length of shaft extension E (mm)	Ball bearings	
			20,000 hrs X _n (N)	X _{max} (N)
71	2	30	415	335
	4	30	415	335
	6	30	415	340
80	2	40	670	545
	4	40	890	725
	6	40	970	830
90 S	2	50	795	625
	4	50	995	780
	6	50	1135	880
90 L	2	50	780	635
	4	50	985	790
	6	50	1120	905
100	2	60	1090	875
	4	60	1360	1095
	6	60	1560	1250
112	2	60	1410	1120
	4	60	1735	1400
	6	60	2000	1620
132 S	2	80	1700	1330
	4	80	2130	1660
	6	80	2495	1935
132 M	2	80	1675	1345
	4	80	2130	1675
	6	80	2450	1960

Flameproof

Motor size	Poles	Length of shaft extension E (mm)	Ball bearings	
			20,000 hrs X _n (N)	X _{max} (N)
80	2	40	650	520
	4	40	830	680
	6	40	900	730
90	2	50	720	575
	4	50	910	780
	6	50	1025	820
100, 112	2	60	1090	860
	4	60	1280	1025
	6	60	1460	1155
132	2	80	1700	1380
	4	80	2020	1610
	6	80	2270	1805

*) Values for frequency converter driven motors on request.

Permissible radial forces (acc. to L₁₀-principle)

Increased safety, non-sparking and dust ignition proof motors, sizes 160-400

Motor size	Poles	Length of shaft extension E (mm)	Ball bearings				Roller bearings			
			20,000 hrs		40,000 hrs		20,000 hrs		40,000 hrs	
			X ₀ (N)	X _{max} (N)	X ₀ (N)	X _{max} (N)	X ₀ (N)	X _{max} (N)	X ₀ (N)	X _{max} (N)
160	2	110	3100	2100	2450	2000	7750	2100	6300	2100
	4	110	3900	2100	3100	2100	8800	2100	7750	2100
	6	110	4500	2100	3550	2100	8800	2100	8750	2100
	8	110	4950	2100	3900	2100	8800	2100	8800	2100
180	2	110	3550	2900	2800	2300	8350	3050	6800	3050
	4	110	4500	3050	3550	2900	9900	3050	8350	3050
	6	110	5150	3050	4100	3050	9900	3050	9450	3050
	8	110	5650	3050	4500	3050	9900	3050	9900	3050
200 ML_	2	110	4800	3950	3800	3150	11700	4550	9500	4550
	4	110	6050	4550	4800	3950	14400	4550	11700	4550
	6	110	6950	4550	5500	4550	16250	4550	13200	4550
	8	110	7650	4550	6050	4550	17700	4550	14400	4550
225 SM_	2	110	5450	4500	4350	3550	14300	4550	11650	4550
	4	140	6900	4650	5450	4400	17650	4650	14300	4650
	6	140	7900	4650	6250	4650	19900	4650	16200	4650
	8	140	8700	4650	6900	4650	21700	4650	17650	4650
250 SM_	2	140	6750	4100	5350	4100	18950	4100	15400	4100
	4	140	8550	5800	6750	5450	23350	5800	18950	5800
	6	140	9800	5800	7750	5800	26400	5800	21400	5800
	8	140	10750	5800	8550	5800	28750	5800	23350	5800
280 SM_	2	140	7300	6000	5800	4900	20400	6000	16500	6000
	4	140	9200	7800	7300	6200	25100	9200	20300	9200
	6	140	10600	8900	8400	7000	28300	9200	23000	9200
	8	140	11700	9200	9200	7800	30900	9200	25100	9200
315 SM_	2	140	7300	6000	5800	4950	20300	6000	16500	6000
	4	170	11400	9400	9000	7450	32500	9600	26600	9600
	6	170	13000	9600	10300	8500	37000	9600	30000	9600
	8	170	14400	9600	11400	9400	40300	9600	32700	9600
315 ML_	2	140	7400	5850	5850	5050	20600	5850	16700	5850
	4	170	11500	9700	9100	7650	32700	13600	26500	13600
	6	170	13200	11100	10400	8800	36900	13600	29900	13600
	8	170	14500	12200	11500	9700	40200	13600	32600	13600
355 S_	2	140	9000	7900	6200	5300	26600	10100	21800	10100
	4	210	15200	12500	12000	9850	45000	22300	36700	22300
	6	210	17300	14200	13700	11300	51000	22300	41500	22300
	8	210	19000	15600	15200	12400	55500	22200	45200	22200
355 SM_	2	140	9000	7900	6100	5300	26700	8900	21800	8900
	4	210	15200	12500	12000	9850	45000	21400	36700	21300
	6	210	17300	14300	13700	11300	51000	21100	41500	21100
	8	210	19000	15700	15200	12400	55500	21700	45200	21700
355 ML_	2	140	9100	7100	6100	5400	26900	7100	21800	7100
	4	210	15200	12800	12000	10100	45500	19500	36700	19500
	6	210	17300	14600	13700	11500	51000	19000	41500	19000
	8	210	19300	16200	15200	12700	55500	19500	45200	19500
400 M_	2	140	9100	7100	6100	5400	26900	7100	21800	7100
	4	210	15200	12800	12000	10100	45500	19500	36700	19500
	6	210	17300	14600	13700	11500	51000	19000	41500	19000
	8	210	19300	16200	15200	12700	55500	19500	45200	19500
400 LK_	2	140	8900	3000	5700	3000	27000	3000	22000	3000
	4	210	15000	13000	11700	10100	46000	15000	37000	15000
	6	210	17200	13700	13600	11700	52000	13700	42000	13700
	8	210	19200	15000	15000	12900	55500	15000	46000	15000

If the radial force is applied between points X₀ and X_{max}, the permissible force F_R can be calculated from the following formula:

$$F_R = F_{X_0} - \frac{X}{E} (F_{X_0} - F_{X_{max}})$$

E = length of shaft extension in basic version

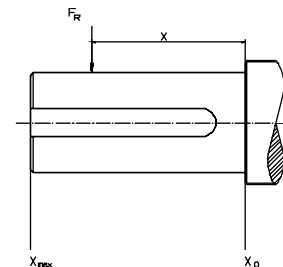

Permissible radial forces (acc. to L₁₀-principle)

Flameproof motors EEx d, EEx de IIB/IIC - sizes 160-250

Motor size	Poles	Length of shaft extension E (mm)	Ball bearings		Roller bearings	
			20.000 hrs		20.000 hrs	
			X ₀ (N)	X _{max} (N)	X ₀ (N)	X _{max} (N)
160	2	110	3020	1900	6700	1600
	4	110	3780	1900	6700	1600
	6	110	4360	1900	6700	1600
	8	110	4810	1900	6700	1600
180	2	110	3420	2780	7500	2400
	4	110	4260	2800	7500	2400
	6	110	4910	2800	7500	2400
	8	110	5440	2800	7500	2400
200 ML₋	2	110	4580	3780	11460	4200
	4	110	5770	4750	14100	4200
	6	110	6590	5000	15000	4200
	8	110	7000	5000	15000	4200
225 SM₋	2	110	5170	3700	9300	3000
	4	140	6520	2800	9300	2200
	6	140	7000	2800	9300	2200
	8	140	7000	2800	9300	2200
250 SM₋	2	140	3200	2900		
	4	140	3000	2800		
	6	140	3000	2800		
	8	140	3000	2800		

Flameproof motors EEx d, EEx de IIB - sizes 280-315

Motor size	Poles	Length of shaft extension E (mm)	Ball bearings		Roller bearings	
			20.000 hrs		20.000 hrs	
			X ₀ (N)	X _{max} (N)	X ₀ (N)	X _{max} (N)
280 SM₋	2	140	7300	6000	20400	6000
	4	140	9200	7800	25100	9200
	6	140	10600	8900	28300	9200
	8	140	11700	9200	30900	9200
315 SM₋	2	140	7300	6000	20300	6000
	4	170	11400	9400	32500	9600
	6	170	13000	9600	37000	9600
	8	170	14400	9600	40000	9600
315 ML₋	2	140	7400	5850	20600	5850
	4	170	11500	9700	32700	13500
	6	170	13200	11100	36900	13500
	8	170	14500	12200	40200	13500

Values for sizes 355 and 400 values available on request.

If the radial force is applied between points X₀ and X₁, the permissible force F_R can be calculated from the following formula:

$$F_R = F_{X_0} - \frac{X}{0.5 \times E} (F_{X_0} - F_{X_1}), \quad 0 \leq X \leq 0.5 \times E$$

Permissible axial forces (acc. to L₁₀-principle)

Mounting arrangement IM B3

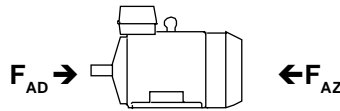

Motor size	20.000 hrs								40.000 hrs							
	2-pole		4-pole		6-pole		8-pole		2-pole		4-pole		6-pole		8-pole	
	F _{AD} N	F _{AZ} N	F _{AD} N	F _{AZ} N	F _{AD} N	F _{AZ} N	F _{AD} N	F _{AZ} N	F _{AD} N	F _{AZ} N	F _{AD} N	F _{AZ} N	F _{AD} N	F _{AZ} N	F _{AD} N	F _{AZ} N
71	270	270	350	350	440	440))))))))))
80	400	400	510	510	590	590))))))))))
90	450	450	560	560	640	640))))))))))
100	620	620	780	780	890	890))))))))))
112	810	810	1020	1020	1170	1170))))))))))
132 S ₋	980	980	1220	1220	1400	1400))))))))))
132 M ₋	980	980	1210	1210	1400	1400))))))))))
160	2550	1890	3310	2650	3890*	3230	4360*	3700	1960	1300	2520	1860	2960	2300	3310	2650
180	2930	2270	3810	3150	4480*	3810	5030*	4370	2240	1580	2890	2230	3390	2700	3810	3140
200	3900	2940	5080	4120	5930*	4970	6650*	5700	2990	2030	3870	2910	4510	3550	5050	4090
225	4370	3250	5680	4570	6640*	5530	7450*	6340	3350	2240	4330	3220	5050	3930	5650	4540
250	5650	3340	7260	4950	8420*	6100	9400*	7100	4400	2100	5610	3300	6460	4160	7200	4900
280	7300	5300	8000	6000	9000	7000	10000	8000	5750	3750	6200	4200	6900	4900	7700	5700
315	7000	5000	9000	7000	10600	8600	11600	9600	5600	3600	6900	4900	7900	5900	8900	6900
355 ²⁾	10500	3500	13500	6500	15300	8300	16800	9800	8750	1750	10800	3800	12000	5000	13300	6300
400 M ₋ ²⁾	10500	3500	13500	6500	15300	8300	16800	9800	8750	1750	10800	3800	12000	5000	13300	6300
400 LK ₋ ²⁾	10100	3200	13000	6000	15000	8000	16500	9500	8350	1350	10200	3250	11800	4800	13000	6000

¹⁾ On request

²⁾The values for sizes 355 and 400 are valid for non-sparking and increased safety M2BA motors. Values for flameproof motors M2JA and M2KA are available on request.

* Axial forces FAD assume locked D-bearing by means of locking ring.

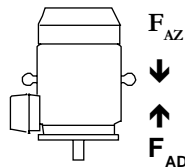

Mounting arrangement IM V1

Motor size	20.000 hrs								40.000 hrs							
	2-pole		4-pole		6-pole		8-pole		2-pole		4-pole		6-pole		8-pole	
	F _{AD} N	F _{AZ} N	F _{AD} N	F _{AZ} N	F _{AD} N	F _{AZ} N	F _{AD} N	F _{AZ} N	F _{AD} N	F _{AZ} N	F _{AD} N	F _{AZ} N	F _{AD} N	F _{AZ} N	F _{AD} N	F _{AZ} N
71	290	260	380	330	460	420))))))))))
80	430	390	540	490	620	560))))))))))
90	480	420	610	520	700	600))))))))))
100	680	580	880	740	990	840))))))))))
112	890	760	1140	950	1280	1100))))))))))
132 S ₋	1100	910	1390	1120	1580	1300))))))))))
132 M ₋	1100	910	1430	1080	1680	1260))))))))))
160	2900	1660	3820	2320	4400*	2900	4880*	3370	2300	1060	3020	1530	3460	1960	3820	2310
180	3370	1970	4510	2680	5200*	3350	5740*	3910	2680	1280	3590	1760	4110	2260	4510	2680
200	4560	2500	5940	3550	6950*	4310	7670*	5040	3650	1590	4720	2330	5510	2880	6060	3420
225	5240	2670	6770	3850	7910*	4700	8740*	5500	4210	1640	5410	2490	6300	3100	6930	3690
250	6700	2630	8590	4080	10100*	5000	11100*	6000	5450	1380	6920	2410	8130	3040	8890	3780
280	8500	4300	9500	4600	11000	5500	12200	6600	6950	2700	7700	2800	8900	3350	9750	4200
315 SM ₋	9000	3700	11600	5400	13500	6200	14500	7500	7450	2100	9450	3200	10900	3650	11900	4650
315 ML ₋	9600	3400	12400	5000	14800	5600	16200	7000	8100	1850	10100	2850	12200	3150	13200	4150
355 S ₋ ²⁾	14100	1600	18500	3800	21200	5000	23000	6800	12200)	15700	10000	18000	1750	19400	3100
355 SM ₋ ²⁾	14900	800	19200	3100	22200	4100	24000	5800	13000)	16400)	18900	850	20300	2100
355 ML ₋ ²⁾	15000)	19800	1700	23100	2500	25000	4300	13100)	17000)	19800)	21300)
400 M ₋ ²⁾	15000)	19800	1700	23100	2500	25000	4300	13100)	17000)	19800)	21300)
400 LK ₋ ²⁾	17300)	21800)	24300	1000	26200	2500	15400)	18900)	21100)	22500)

¹⁾ On request

²⁾The values for sizes 355 and 400 are valid for non-sparking and increased safety M2BA motors. Values for flameproof motors M2JA and M2KA are available on request.

* Axial forces FAD assume locked D-bearing by means of locking ring.

Flameproof motors EEx d and EEx de

Range

Range	Standards	Motor sizes	Output
Flameproof EEx d IIB/IIC T1 - T6	EN 50014, 50018	80 - 400	0.55 - 630 kW
Flameproof EEx de IIB/IIC T1 - T6	EN 50014, 50018, 50019	80 - 400	0.55 - 630 kW

Terminal box, general

Terminal boxes are mounted on the top of the basic versions of flameproof motors. The terminal box of motor sizes 80 to 250 can be turned 4 x 90°, in motor sizes 160 to 180 of type EEx de and sizes 280 to 400 2x 180° after the delivery; to allow cable entry from either side of the motor. In motor sizes 160 to 180 (EEx de) as an easy option and in sizes 280 to 400 the position of terminal box has to be defined when ordering by 4 x 90°.

The terminal box can be equipped with cable glands or from motor size 280 with cable boxes in motor type EEx de. Terminations are suitable for Cu- and Al-cables. For a horizontal mounted motor the cable entry is normally located on the right-hand side, seen from D-end, for other positions see variant codes. Protection class is IP 55.

Flameproof terminal box (EEx d-motor)

The flameproof terminal box complies with the requirements of this enclosure type and effectively stops the transmission of an internal explosion to the surrounding, potentially explosive atmosphere.

To maintain the integrity of this enclosure, connections must be made in accordance with the safety standards applicable to this type of terminal box. Furthermore, sealing must be selected corresponding to the type of supply cable used.

Cable entries

Unless otherwise specified, motors are delivered **without** cable glands with threaded cable entries for flameproof cable gland according to the table below. In frame sizes 100 to 400, the terminal box has two main cable entries with metric thread, one plugged with a

flameproof metal plug. The auxiliary cable entry is also with metric thread, plugged with a flameproof metal plug. NPT threads are available on request. During the transition period from NPT to metric threads please check when ordering.

Metric threads (as standard)

Motor size	Main cable entries			Auxiliary cable entries (heaters, thermistors etc.)		
	Thread	Metal plug	Outer cable sheath, mm	Thread	Metal plug	Outer cable sheath, mm
80 - 90	1 x M25 x1.5	–	12 - 20.5	1 x M20 x 1.5	1 x M20 x 1.5	8.5 - 16
100 - 132	2 x M32 x1.5	1 x M32	12 - 21	1 x M20 x 1.5	1 x M20 x 1.5	8.5 - 16
160 - 180	2 x M40 x1.5	1 x M40	16 - 27.5	2 x M20 x 1.5	2 x M20 x 1.5	8.5 - 16
200 - 250	2 x M50 x1.5	1 x M50	21 - 34	2 x M20 x 1.5	2 x M20 x 1.5	8.5 - 16
280	2 x M63 x1.5	1 x M63	33 - 48	2 x M20 x 1.5	2 x M20 x 1.5	8.5 - 16
315	2 x M75 x1.5	1 x M75	47 - 65	2 x M20 x 1.5	2 x M20 x 1.5	8.5 - 16
355 - 400	2 x M75 x1.5	1 x M75	47 - 65	2 x M20 x 1.5	2 x M20 x 1.5	8.5 - 16

NPT threads as option, variant code 730 = Prepared for NPT cable glands

Motor size	Main cable entries			Auxiliary cable entries (heaters, thermistors etc.)	
	Thread	NPT plug	Max. possible thread size	Thread	NPT plug
80-112	1x3/4"	–	1 or 2x1"	1x3/4"	1x3/4"
132	2x3/4"	1x3/4"	1 or 2x1"	1x3/4"	1x3/4"
160-180	2x1 1/4"	1x1 1/4"	1 or 2x1 1/2"	2x3/4"	2x3/4"
200-250	2x1 1/2"	1x1 1/2"	1 or 2x2"	2x3/4"	2x3/4"
280	2x2"	1x2"	1 or 2x3"	1x3/4"	1x3/4"
315	2x3"	1x3"	1 or 2x3"	1x3/4"	1x3/4"
355-400	2x3"	1x3"	1 or 2x4"	1x3/4"	1x3/4"

Supply of cable glands (EEx d)

Cable glands are either fitted to the motor, or delivered loose to avoid damage during transport. For ordering, see variant codes. Other types are available on request.

Unless otherwise specified when ordering cable glands, and when data on the cables have not been provided when ordering, the cable glands listed below will be delivered. The unused opening is closed with a flameproof metal plug.

Variant code: 733 **Standard cable gland EEx d IIB, non-armoured cable**
735 **Standard cable gland EEx d IIC, non-armoured cable**

Motor size	Main cable entries			Auxiliary cable entries (heaters, thermistors etc.)					
	Thread	Gland	Closing plug	Outer cable diameter, mm		Thread	Gland	Outer cable diameter, mm	
				IIB	IIC			IIB	IIC
80 - 90	1xM25 x 1.5	1xM25	–	12 - 20.5	11 - 20	1xM20 x 1.5	1xM20	8.5 - 16	7 - 15
100 - 132	2xM32 x 1.5	1xM32	1xM32	12 - 21	16 - 27.5	1xM20 x 1.5	2xM20	8.5 - 16	7 - 15
160 - 180	2xM40 x 1.5	1xM40	1xM40	16 - 27.5	22 - 33	2xM20 x 1.5	2xM20	8.5 - 16	7 - 15
200 - 250	2xM50 x 1.5	1xM50	1xM50	21 - 34	30 - 44	2xM20 x 1.5	2xM20	8.5 - 16	7 - 15
280	2xM63 x 1.5	1xM63	1xM63	33 - 48	40 - 57	2xM20 x 1.5	2xM20	8.5 - 16	7 - 15
315 - 400	2xM75 x 1.5	1xM75	1xM75	47 - 65	56 - 68	2xM20 x 1.5	2xM20	8.5 - 16	7 - 15

Variant code: 732 **Standard cable gland EEx d IIB, armoured cable**
734 **Standard cable gland EEx d IIC, armoured cable**

Motor size	Main cable entries				Auxiliary cable entries (heaters, thermistors etc.)								
	Thread	Gland	Closing plug	Inner cable sheath		Outer cable sheath		Thread	Gland	Inner cable sheath		Outer cable sheath	
				mm	IIC	mm	IIC			mm	IIC	mm	IIC
80 - 90	1xM25 x 1.5	1xM25	–	12-20.5	11-20	16-27.5	18-27.5	1xM20 x 1.5	1xM20	8.5-16	7-15	12-21	13-21
100 - 132	2xM32 x 1.5	1xM32	1xM32	12-21	16-27.5	16-27.5	23.5-33.5	1xM20 x 1.5	1xM20	8.5-16	7-15	12-21	13-21
160 - 180	2xM40 x 1.5	1xM40	1xM40	16-27.5	22-33	21-34	29-40.5	2xM20 x 1.5	2xM20	8.5-16	7-15	12-21	13-21
200 - 250	2xM50 x 1.5	1xM50	1xM50	21-34	30-44	27-41	40-53	2xM20 x 1.5	2xM20	8.5-16	7-15	12-21	13-21
280	2xM63 x 1.5	1xM63	1xM63	33-48	40-57	40-56	51-66	2xM20 x 1.5	2xM20	8.5-16	7-15	12-21	13-21
315 - 400	2xM75 x 1.5	1xM75	1xM75	47-65	56-68	54-74	64-78	2xM20 x 1.5	2xM20	8.5-16	7-15	12-21	13-21

Examples of terminal boxes:

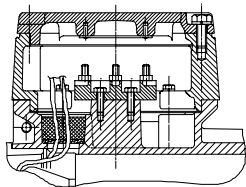

Terminal box for motor sizes 80 - 132

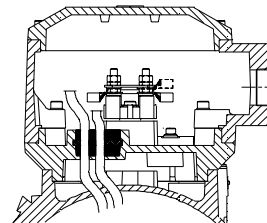

Terminal box for motor sizes 200 - 250

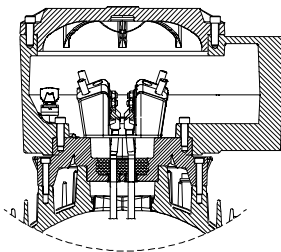

Terminal box for motor sizes 280 - 315

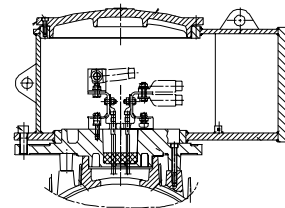

Terminal box for motor sizes 355 - 400

Increased safety terminal box (EEx de-motors)

As an alternative, an increased safety terminal box can be delivered with a flameproof motor enclosure. The certificate of approval for the flameproof motors also covers this application, referred to as EEx de.

The increased safety terminal box complies with the requirements of this type of enclosure and prevents all

ignition sources such as sparks, excessive overheating etc. The features of the terminal box are: no self-loosening terminals, compliance with creepage distances and clearances specified in standards and cable gland with cable clamping.

Cable entries

Motor sizes 80 to 132 are delivered **without** cable glands but are delivered with threaded cable entries suitable for the following cable glands as standard. Motor sizes 160 to 400 are delivered **with** cable glands according to the table below as standard.

In frame sizes 100 to 132 the terminal box has two main cable entries with metric thread, one plugged with a metal plug. In frame sizes 160 to 250 the terminal box has also two main cable entries with metric threads; both are equipped with cable glands of a closed type. In frame sizes 280 to 400 the terminal box has two main metric cable glands, one equipped with a cable gland, one with a metal plug.

Motor size	Main cable entries				Auxiliary cable entries (heaters, thermistors etc.)			
	Thread	Cable gland	Metal plug	Outer cable sheath, mm	Thread	Cable gland	Metal plug	Outer cable sheath, mm
80 - 90	1 x M25 x1.5	–	–	10 - 16	1 x M20 x 1.5	–	1 x M20 x 1.5	8 - 14
100 - 132	2 x M32 x1.5	–	1xM32	14 - 21	1 x M20 x 1.5	–	1 x M20 x 1.5	8 - 14
160 - 180	2 x M40 x1.5	2xM40x1.5	–	18 - 27	2 x M20 x 1.5	2 x M20 x 1.5	–	8 - 14
200 - 250	2 x M50 x1.5	2xM50x1.5	–	26 - 35	2 x M20 x 1.5	2 x M20 x 1.5	–	8 - 14
280	2 x M63 x1.5	1 x M63	1 x M63	32 - 49	2 x M20 x 1.5	2 x M20 x 1.5	–	8 - 14
315	2 x M63 x1.5	1 x M63	1 x M63	32 - 49	2 x M20 x 1.5	2 x M20 x 1.5	–	8 - 14
355 - 400	See tables on next pages.							

Supply of cable glands (EEx de)

Cable glands are either fitted to the motor, or delivered loose to avoid damage during transport. For ordering, see variant codes.

Unless otherwise specified when ordering cable glands, and when data on the cables have not been provided when ordering, the cable glands listed on the next page will be delivered. Other types are available on request.

Examples of terminal boxes:

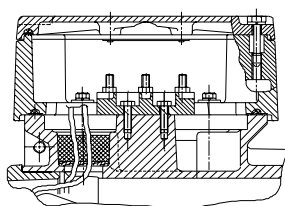

Terminal box for motors sizes 80 - 132

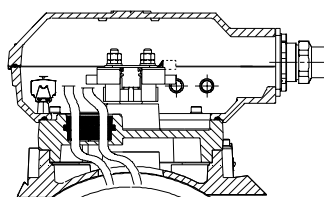

Terminal box for motors sizes 160 - 250

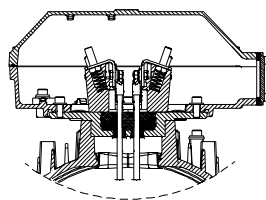

Terminal box for motors sizes 280 - 315

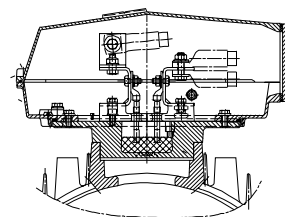

Terminal box for motors sizes 355 - 400

Flameproof motors sizes 280-400

Motors (EEx de) with top-mounted terminal box

Motor size	Flange or adapter	Cable box or cable gland	Gland thread	Cable diameter	Max. connection cable area mm ²	Terminal bolt size	Voltage/frequency code
3000 r/min (2 poles)							
280	3GZF 294 730-749	2x 3GZF 294 730-613	2x M63x1.5	2x Ø32-49	2x150	M12	
315	3GZF 294 730-753	2x 3GZF 294 730-613	2x M63x1.5	2x Ø32-49	2x240	M12	
355 S	MPMM-ZL1	3GZF 294 730-301		2x Ø48-60	4x240	M12	D
	-	3GZF 294 730-301		2x Ø48-60	2x240	M12	E
355 SM __	MPMM-ZL1	3GZF 294 730-301		2x Ø48-60	4x240	M12	
355 ML __	MPMM-ZL1	LNPB 3328		2x Ø60-80	4x240	M12	
400 M __	MPMM-ZL1	LNPB 3328		2x Ø60-80	4x240	M12	
400 LK __	MPMM-ZL1	LNPB 3328		2x Ø60-80	4x240	M12	
1500 r/min (4 poles)							
280	3GZF 294 730-749	2x 3GZF 294 730-613	2x M63x1.5	2x Ø32-49	2x150	M12	
315	3GZF 294 730-753	2x 3GZF 294 730-613	2x M63x1.5	2x Ø32-49	2x240	M12	
355 S	MPMM-ZL1	3GZF 294 730-301		2x Ø48-60	4x240	M12	D
	-	3GZF 294 730-301		2x Ø48-60	2x240	M12	E
355 SM __	MPMM-ZL1	3GZF 294 730-301		2x Ø48-60	4x240	M12	
355 ML __	MPMM-ZL1	LNPB 3328		2x Ø60-80	4x240	M12	
400 M __	MPMM-ZL1	LNPB 3328		2x Ø60-80	4x240	M12	
400 LKA	MPMM-ZL1	LNPB 3328		2x Ø60-80	4x240	M12	D
	MPMM-ZL1	LNPB 3328		2x Ø60-80	4x240	M12	E
400 LKB, LKC	MPMM-ZL1	LNPB 3328		2x Ø60-80	4x240	M12	
1000 r/min (6 poles)							
280	3GZF 294 730-749	2x 3GZF 294 730-613	2x M63x1.5	2x Ø32-49	2x150	M12	
315	3GZF 294 730-753	2x 3GZF 294 730-613	2x M63x1.5	2x Ø32-49	2x240	M12	
355 S, SMA	-	3GZF 294 730-301		2x Ø48-60	2x240	M12	
355 SMB	MPMM-ZL1	3GZF 294 730-301		2x Ø48-60	4x240	M12	D
	-	3GZF 294 730-301		2x Ø48-60	2x240	M12	E
355 ML __	MPMM-ZL1	3GZF 294 730-301		2x Ø48-60	4x240	M12	
400 M	MPMM-ZL1	LNPB 3328		2x Ø60-80	4x240	M12	D
	-	3GZF 294 730-301		2x Ø48-60	2x240	M12	E
400 MA, MB	MPMM-ZL1	LNPB 3328		2x Ø60-80	4x240	M12	
400 LKA	MPMM-ZL1	LNPB 3328		2x Ø60-80	4x240	M12	
400 LKB, LKC	MPMM-ZL1	LNPB 3328		2x Ø60-80	4x240	M12	D
	MPMM-ZL1	LNPB 3328		2x Ø60-80	4x240	M12	E
750 r/min (8 poles)							
280	3GZF 294 730-749	2x 3GZF 294 730-613	2x M63x1.5	2x Ø32-49	2x150	M12	
315	3GZF 294 730-753	2x 3GZF 294 730-613	2x M63x1.5	2x Ø32-49	2x240	M12	
355 S, SMA	-	3GZF 294 730-301		2x Ø48-60	2x240	M12	
355 MLA	-	3GZF 294 730-301		2x Ø48-60	2x240	M12	
355 MLC	MPMM-ZL1	3GZF 294 730-301		2x Ø48-60	4x240	M12	D
	-	3GZF 294 730-301		2x Ø48-60	2x240	M12	E
400 M	-	3GZF 294 730-301		2x Ø48-60	2x240	M12	D
400 MA	MPMM-ZL1	3GZF 294 730-301		2x Ø48-60	4x240	M12	D
	-	3GZF 294 730-301		2x Ø48-60	2x240	M12	E
400 LK __	MPMM-ZL1	LNPB 3328		2x Ø60-80	4x240	M12	

Voltage/frequency codes:

D - 380-420 VΔ 50 Hz, 660-690 VY 50 Hz, 440-480 VΔ 60 Hz

E - 500 VΔ 50 Hz, 575 VΔ 60 Hz

Examples:

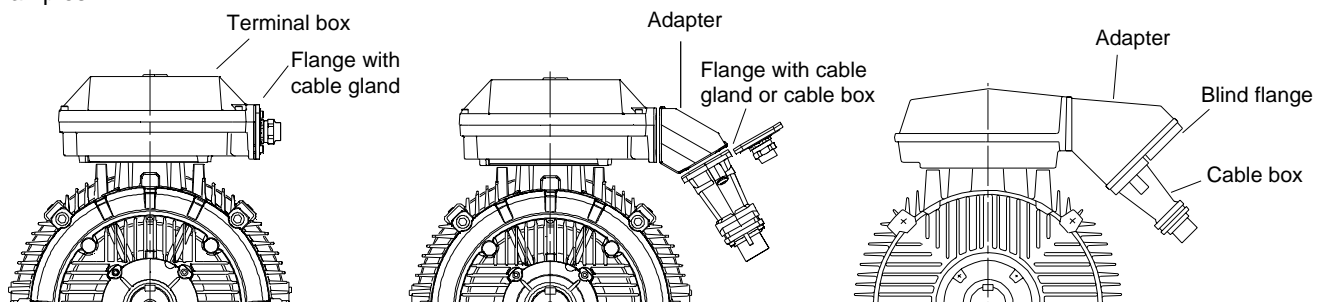

Technical data – Flameproof motors

EEx d IIB/IIC T4, EEx de IIB/IIC T4



IP 55, IC 411; Insulation class F, temperature rise class B

Output			Efficiency		Speed	Powe factor	Current		Torque			Moment of inertia		Weight	Sound pressure level L_p	
kW	Type	Product	Full load	3/4-load			I_N	I_s	T_N	T_s	T_{max}	J=1/4 GD ²	EEx d			EEx de
400V 440V 50Hz 60Hz	designation	code	r/min	100%	75%	cos φ	A	—	Nm	T_N	T_N	kgm ²	kg	dB(A)		
3000 r/min = 2 poles			400 V 50 Hz ¹⁾			Basic design										
0.75	0.9	M2JA/KA 80 LS	3GJA/KA 081 310-***B	2905	75.5	79.3	0.70	2.2	8.2	2.5	4.0	3.5	0.0009	24	24	59
1.1	1.3	M2JA/KA 80 L	3GJA/KA 081 320-***B	2850	78.3	77.5	0.82	2.6	6.4	3.7	2.5	2.9	0.0009	24	24	59
1.5	1.75	M2JA/KA 90 S	3GJA/KA 091 110-***B	2880	80.1	81.9	0.86	3.3	6.7	5	2.3	2.8	0.0019	32	32	65
2.2	2.5	M2JA/KA 90 L	3GJA/KA 091 510-***B	2880	83.0	84.0	0.88	4.6	7.6	7.3	2.7	3.3	0.0024	37	37	65
3	3.5	M2JA/KA 100 L	3GJA/KA 101 510-***B	2910	84.8	84.5	0.88	6.1	7.7	9.8	2.6	3.4	0.0041	45	45	66
4	4.6	M2JA/KA 112 M	3GJA/KA 111 310-***B	2900	84.8	86.2	0.90	7.7	7.2	13.2	2.4	3.1	0.005	46	46	67
5.5	6.3	M2JA/KA 132 SA	3GJA/KA 131 110-***B	2855	84.5	84.8	0.89	10.6	6.5	18.4	3.2	3.5	0.014	69	69	69
7.5	8.6 ²⁾	M2JA/KA 132 SB	3GJA/KA 131 120-***B	2855	86.3	87.0	0.90	14.7	8.5	25	3.4	3.5	0.016	79	79	69
11	12.5	M3JP/KP 160 MLA	3GJP/KP 161 410-***G	2936	91.2	91.1	0.87	20	7.2	36	2.9	3.3	0.039	153	147	71
15	17	M3JP/KP 160 MLB	3GJP/KP 161 420-***G	2934	91.6	91.5	0.88	28	7.5	49	3.1	3.5	0.047	162	156	71
18.5	21	M3JP/KP 160 MLC	3GJP/KP 161 430-***G	2934	92.4	92.5	0.90	33	7.5	60	2.8	3.4	0.054	173	167	71
22	25	M3JP/KP 180 MLA	3GJP/KP 181 410-***G	2938	92.6	92.7	0.90	39	6.9	72	2.5	3.1	0.077	200	194	71
30	35	M3JP/KP 200 MLA	3GJP/KP 201 410-***G	2946	94.0	94.1	0.88	54	7.4	97	3.0	3.2	0.15	310	290	74
37	43	M3JP/KP 200 MLC	3GJP/KP 201 430-***G	2948	94.1	94.0	0.89	65	7.6	120	2.9	3.2	0.19	340	320	77
45	52	M3JP/KP 225 SMB	3GJP/KP 221 220-***G	2968	94.7	94.6	0.87	79	7.2	145	2.7	3.0	0.26	400	380	76
55	63	M3JP/KP 250 SMA	3GJP/KP 251 210-***G	2970	94.6	94.3	0.88	96	7.7	177	2.4	3.1	0.49	460	440	75
75	90	M3JP/KP 280 SMA	3GJP/KP 281 210-***G	2978	94.8	94.3	0.88	131	7.6	240	2.1	3.0	0.8	725	645	77
90	105	M3JP/KP 280 SMB	3GJP/KP 281 220-***G	2976	95.1	94.8	0.90	152	7.4	289	2.1	2.9	0.9	765	685	77
110	125	M3JP/KP 315 SMA	3GJP/KP 311 210-***G	2982	95.1	94.4	0.86	194	7.6	352	2.0	3.0	1.2	980	900	78
132	155	M3JP/KP 315 SMB	3GJP/KP 311 220-***G	2982	95.4	94.9	0.88	228	7.4	423	2.2	3.0	1.4	1040	960	78
160	185	M3JP/KP 315 SMC	3GJP/KP 311 230-***G	2981	96.1	95.6	0.89	269	7.5	513	2.3	3.0	1.7	1125	1045	78
200	230	M3JP/KP 315 MLA	3GJP/KP 311 410-***G	2980	96.3	95.9	0.90	336	7.7	641	2.6	3.0	2.1	1290	1210	78
250	285	M2JA/KA 355 S	3GJA/KA 351 100-***A	2980	96.1	95.7	0.92	410	6.6	801	1.3	3.0	3.8	1550	1550	83
315	360	M2JA/KA 355 SMA	3GJA/KA 351 210-***A	2978	96.6	96.4	0.92	510	7.7	1010	1.3	3.3	4.8	1750	1750	83
400	450	M2JA/KA 355 MLA	3GJA/KA 351 410-***A	2982	96.6	96.4	0.92	655	7.7	1281	1.6	3.3	6	2150	2150	83
450	500 ²⁾	M2JA/KA 355 MLC	3GJA/KA 351 430-***A	2977	96.6	96.4	0.92	730	7.8	1444	1.2	3.2	6	2150	2150	83
400	450	M2JA/KA 400 M	3GJA/KA 401 300-***A	2982	96.6	96.4	0.92	655	7.7	1281	1.6	3.3	6	2200	2200	83
450	500 ²⁾	M2JA/KA 400 MA	3GJA/KA 401 310-***A	2977	96.6	96.4	0.92	730	7.8	1444	1.2	3.2	6	2200	2200	83
500	0 ²⁾	M2JA/KA 400 LKA	3GJA/KA 401 510-***A	2980	96.6	96.5	0.93	795	7.0	1602	0.8	2.8	7.5	2850	2850	85
560	0 ²⁾	M2JA/KA 400 LKB	3GJA/KA 401 520-***A	2983	96.7	96.5	0.92	910	7.3	1793	0.7	3.4	8.5	2900	2900	85

3000 r/min = 2 poles			400 V 50 Hz ¹⁾			High-output design										
22	25	M3JP/KP 160 MLD	3GJP/KP 161 440-***G	2929	91.4	91.3	0.90	39	7.4	72	2.8	3.4	0.059	179	173	77
30	34	M3JP/KP 180 MLB	3GJP/KP 181 420-***G	2944	92.8	92.7	0.88	54	7.5	97	2.8	3.5	0.092	216	210	78
55	63	M3JP/KP 225 SMC	3GJP/KP 221 230-***G	2965	94.3	94.0	0.88	96	7.1	177	2.6	3.0	0.29	420	400	80
75	86	M3JP/KP 250 SMB	3GJP/KP 251 220-***G	2969	95.1	95.0	0.89	129	7.9	241	2.6	3.2	0.57	500	480	80
110	125	M3JP/KP 280 SMC	3GJP/KP 281 230-***G	2978	95.7	95.3	0.90	185	7.9	353	2.4	3.0	1.15	825	745	77

¹⁾ Motors are certified for the voltages 380-400-415 V 50 Hz according to IEC 60034-1. Values above are given for 400 V 50 Hz; data for other voltages on request.

Detailed data for 440 V 60 Hz on request.

²⁾ Temperature rise class F

ATEX certification process ongoing for frame sizes 355-400.

Notes:

- When ordering sizes 160-200 with lifetime lubrication, variant code 194 'ZZ bearings at both ends' has to be added
- When ordering IIC motors, following variant code has to be added: 461 = EEx d, EEx de design, Group IIC

Data for other voltages and frequencies; and for surface temperature T5 on request.

2- and 4-pole Cenelec motors sizes 160-250 can be used at ambient 50°C in temperature rise max. 75 K (cl. F); for more information contact us.

The two bullets in the product code indicate choice of mounting arrangement (see ordering information), voltage and frequency (below).

S	D	A ^{a)}	B ^{a)}	E	F ^{b)}	X
380 VY 50 Hz	380 VΔ 50 Hz	380 VY 50 Hz	380 VΔ 50 Hz	500 VΔ 50 Hz	500 VY 50 Hz	Other rated voltage, connection or frequency, max. 690 V
400 VY 50 Hz	400 VΔ 50 Hz	220 VΔ 50 Hz	660 VY 50 Hz	575 VΔ 60 Hz		
415 VY 50 Hz	415 VΔ 50 Hz					
220 VΔ 50 Hz	660 VY 50 Hz	G ^{a)}	H ^{a)}	T ^{b)}	U ^{b)}	
230 VΔ 50 Hz	690 VY 50 Hz	415 VY 50 Hz	415 VΔ 50 Hz	660 VΔ 50 Hz	690 VΔ 50 Hz	
440 VY 60 Hz	440 VΔ 60 Hz					

^{a)} On request for motor sizes 315-400.

^{b)} On request for motor sizes 355-400.

Technical data – Flameproof motors

EEx d IIB/IIC T4, EEx de IIB/IIC T4



IP 55, IC 411; Insulation class F, temperature rise class B

Output kW	400V 440V 50Hz 60Hz	Type designation	Product code	Speed r/min	Efficiency		Power factor cos φ	Current		Torque			Moment of inertia		Weight EEx d kg	Sound pressure level L _p dB(A)
					Full load 100%	3/4- load 75%		I _N	I _s	T _N	T _s	T _{max}	J=1/4 GD ²	EEx de		
1500 r/min = 4 poles					400 V 50 Hz ¹⁾					Basic design						
0.55	0.65	M2JA/KA 80 LS	3GJA/KA 082 310---B	1440	76.2	76.9	0.62	1.7	6.1	3.6	3.2	3.4	0.002	24	24	45
0.75	0.9	M2JA/KA 80 L	3GJA/KA 082 320---B	1405	77.0	78.1	0.77	2	5.2	5	2.7	2.9	0.002	24	24	45
1.1	1.3	M2JA/KA 90 S	3GJA/KA 092 110---B	1420	76.0	77.3	0.79	2.7	4.3	7.4	2.0	2.5	0.0032	32	32	54
1.5	1.75	M2JA/KA 90 L	3GJA/KA 092 510---B	1420	77.8	77.4	0.78	3.5	4.9	10.1	2.6	3.0	0.0043	36	36	54
2.2	2.5	M2JA/KA 100 LA	3GJA/KA 102 510---B	1435	81.2	80.8	0.81	4.8	6.3	14.6	2.4	2.4	0.0069	44	44	52
3	3.5	M2JA/KA 100 LB	3GJA/KA 102 520---B	1435	82.7	80.8	0.80	6.5	6.7	20	2.7	2.9	0.0082	47	47	52
4	4.6 ²⁾	M2JA/KA 112 M	3GJA/KA 112 310---B	1440	82.8	83.0	0.80	9.5	6.3	27	3.0	3.1	0.01	51	51	60
5.5	6.3	M2JA/KA 132 S	3GJA/KA 132 110---B	1450	86.1	84.7	0.84	11.3	7.2	36.1	2.2	3.0	0.031	79	79	59
7.5	8.6 ²⁾	M2JA/KA 132 M	3GJA/KA 132 310---B	1450	86.0	86.4	0.85	15.5	7.9	49.3	2.6	3.4	0.038	82	82	59
11	12.5	M3JP/KP 160 MLC	3GJP/KP 162 430---G	1470	91.3	91.3	0.82	22.5	7.7	71	3.1	3.6	0.09	172	166	62
15	17	M3JP/KP 160 MLE	3GJP/KP 162 450---G	1467	92.0	92.0	0.83	30	7.6	98	3.1	3.6	0.121	195	189	67
18.5	21	M3JP/KP 180 MLA	3GJP/KP 182 410---G	1474	92.5	92.6	0.82	36	7.3	120	2.7	3.2	0.176	212	206	62
22	25	M3JP/KP 180 MLB	3GJP/KP 182 420---G	1471	92.6	92.7	0.82	42	7.1	143	2.6	3.0	0.191	220	214	62
30	35	M3JP/KP 200 MLB	3GJP/KP 202 420---G	1475	93.5	93.6	0.84	56	7.4	194	3.3	3.0	0.34	340	320	61
37	42	M3JP/KP 225 SMB	3GJP/KP 222 220---G	1480	93.6	93.4	0.84	69	7.7	239	3.1	3.1	0.42	390	370	67
45	52	M3JP/KP 225 SMC	3GJP/KP 222 230---G	1477	94.4	94.4	0.86	81	7.4	291	3.1	3.0	0.49	425	405	67
55	63	M3JP/KP 250 SMA	3GJP/KP 252 210---G	1479	94.6	94.7	0.83	101	6.9	355	2.5	3.1	0.72	450	430	66
75	88	M3JP/KP 280 SMA	3GJP/KP 282 210---G	1484	94.9	94.8	0.85	135	6.9	483	2.5	2.8	1.25	725	645	68
90	105	M3JP/KP 280 SMB	3GJP/KP 282 220---G	1483	95.2	95.2	0.86	159	7.2	580	2.5	2.7	1.5	765	685	68
110	125	M3JP/KP 315 SMA	3GJP/KP 312 210---G	1487	95.6	95.4	0.86	193	7.2	706	2.0	2.5	2.3	1000	920	70
132	150	M3JP/KP 315 SMB	3GJP/KP 312 220---G	1487	95.8	95.6	0.86	232	7.1	848	2.3	2.7	2.6	1060	980	70
160	185	M3JP/KP 315 SMC	3GJP/KP 312 230---G	1487	96.0	95.9	0.85	287	7.2	1028	2.4	2.9	2.9	1100	1020	70
200	230	M3JP/KP 315 MLA	3GJP/KP 312 410---G	1486	96.2	96.2	0.86	351	7.2	1285	2.5	2.9	3.5	1260	1180	70
250	285	M2JA/KA 355 S	3GJA/KA 352 100---A	1487	96.5	96.4	0.87	430	7.2	1606	2.3	2.7	6.5	1550	1550	80
315	360	M2JA/KA 355 SMA	3GJA/KA 352 210---A	1488	96.7	96.6	0.87	545	7.6	2022	2.5	2.9	8.2	1800	1800	80
355	400	M2JA/KA 355 SMB	3GJA/KA 352 220---A	1486	96.7	96.7	0.87	610	6.8	2281	2.2	2.6	8.2	1800	1800	80
400	450	M2JA/KA 355 MLA	3GJA/KA 352 410---A	1489	96.8	96.8	0.87	685	6.9	2565	1.6	2.8	10	2100	2100	80
450	500 ²⁾	M2JA/KA 355 MLB	3GJA/KA 352 420---A	1489	96.8	96.8	0.87	770	7.6	2886	1.5	3.0	10	2100	2100	80
500	560	M2JA/KA 355 MLC	3GJA/KA 352 430---A	1489	96.8	96.8	0.88	845	7.6	3207	1.3	2.9	10.5	2100	2100	83
400	450	M2JA/KA 400 M	3GJA/KA 402 300---A	1489	96.8	96.8	0.87	685	6.9	2565	1.6	2.8	10	2150	2150	80
450	500 ²⁾	M2JA/KA 400 MA	3GJA/KA 402 310---A	1489	96.8	96.8	0.87	770	7.6	2886	1.5	3.0	10	2150	2150	80
500	560	M2JA/KA 400 MB	3GJA/KA 402 320---A	1489	96.8	96.8	0.88	845	7.6	3207	1.3	2.9	10.5	2150	2150	83
560	630	M2JA/KA 400 LKA	3GJA/KA 402 510---A	1489	96.9	96.9	0.90	925	6.6	3591	1.1	2.6	14	3050	3050	85
630	710	M2JA/KA 400 LKB	3GJA/KA 402 520---A	1489	96.9	96.8	0.87	1080	6.9	4040	1.2	2.8	15	3150	3150	85
1500 r/min = 4 poles					400 V 50 Hz ¹⁾					High-output design						
18.5	21	M3JP/KP 160 MLF	3GJP/KP 162 460---G	1466	92.0	92.0	0.82	36.5	8	120	3.2	3.6	0.121	195	189	68
30	34 ²⁾	M3JP/KP 180 MLC	3GJP/KP 182 430---G	1473	92.3	92.3	0.80	59	7.8	194	3.1	3.4	0.239	239	233	66
37	42	M3JP/KP 200 MLC	3GJP/KP 202 430---G	1475	93.3	93.3	0.82	70	7.5	239	3.5	3.2	0.34	340	320	73
55	63	M3JP/KP 225 SMD	3GJP/KP 222 240---G	1476	94.0	93.9	0.85	100	7.6	356	3.3	3.1	0.49	425	405	74
75	86	M3JP/KP 250 SMB	3GJP/KP 252 220---G	1476	94.7	94.9	0.86	133	7.2	485	2.7	3.2	0.88	505	485	73
110	125	M3JP/KP 280 SMC	3GJP/KP 282 230---G	1485	95.6	95.5	0.86	195	7.6	707	3.0	3.0	1.85	825	745	68

¹⁾ Motors are certified for the voltages 380-400-415 V 50 Hz according to IEC 60034-1. Values above are given for 400 V 50 Hz; data for other voltages on request.

²⁾ Temperature rise class F

Detailed data for 440 V 60 Hz on request.

ATEX certification process ongoing for frame sizes 355-400.

Notes:

- When ordering sizes 160-200 with lifetime lubrication, variant code 194 '2Z bearings at both ends' has to be added
- When ordering IIC motors, following variant code has to be added: 461 = EEx d, EEx de design, Group IIC

Data for other voltages and frequencies; and for surface temperature T5 on request.

2- and 4-pole Cenelec motors sizes 160-250 can be used at ambient 50°C in temperature rise max. 75 K (cl. F); for more information contact us.

Technical data – Flameproof motors

EEx d IIB/IIC T4, EEx de IIB/IIC T4



IP 55, IC 411; Insulation class F, temperature rise class B

Output kW	400V 440V 50Hz 60Hz	Type designation	Product code	Speed r/min	Efficiency		Power factor cos φ	Current		Torque			Moment of inertia		Weight		Sound pressure level L _p dB(A)
					Full load	3/4- load		I _N	I _s	T _N	T _s	T _{max}	J=1/4 GD ² kgm ²	EEx d kg	EEx de		
1000 r/min = 6 poles																	
400 V 50 Hz ¹⁾																	
Basic design																	
0.37	0.45	M2JA/KA 80 LS	3GJA/KA 083 310-***B	945	66.8	64.0	0.50	1.7	4.2	3.7	4.3	4.4	0.002	24	24	42	
0.55	0.65	M2JA/KA 80 L	3GJA/KA 083 320-***B	910	67.0	69.2	0.62	2	3.8	5.7	2.8	2.9	0.002	24	24	42	
0.75	0.9	M2JA/KA 90 S	3GJA/KA 093 110-***B	930	69.1	69.6	0.67	2.4	3.7	7.7	2.1	2.3	0.0032	32	32	44	
1.1	1.3	M2JA/KA 90 L	3GJA/KA 093 510-***B	930	72.8	70.9	0.69	3.3	4.3	11.3	2.4	2.7	0.0043	37	37	44	
1.5	1.75	M2JA/KA 100 L	3GJA/KA 103 510-***B	950	78.0	77.5	0.71	4.2	4.9	15.1	1.8	2.4	0.0082	47	47	47	
2.2	2.5	M2JA/KA 112 M	3GJA/KA 113 310-***B	950	78.2	79.9	0.71	5.9	4.8	22.1	2.3	2.5	0.01	51	51	50	
3	3.5	M2JA/KA 132 S	3GJA/KA 133 110-***B	960	83.6	81.1	0.75	7.1	6.4	29.8	2.4	3.1	0.031	79	79	61	
4	4.6	M2JA/KA 132 MA	3GJA/KA 133 310-***B	960	84.8	85.2	0.78	8.9	7.1	40	2.6	2.8	0.038	82	82	61	
5.5	6.3	M2JA/KA 132 MB	3GJA/KA 133 320-***B	955	84.8	85.7	0.78	12.2	6.9	55	2.8	2.8	0.045	96	96	61	
7.5	8.6	M3JP/KP 160 MLA	3GJP/KP 163 410-***G	965	88.6	89.3	0.80	15.5	6.5	74	1.9	3.0	0.088	166	160	57	
11	12.5	M3JP/KP 160 MLB	3GJP/KP 163 420-***G	965	89.2	89.9	0.79	23	7.1	109	2.1	3.3	0.106	179	173	65	
15	17	M3JP/KP 180 MLB	3GJP/KP 183 420-***G	972	91.1	91.3	0.80	31	7.0	147	1.9	3.3	0.221	239	233	67	
18.5	21	M3JP/KP 200 MLA	3GJP/KP 203 410-***G	983	91.3	91.4	0.80	37	7.1	180	3.2	3.1	0.37	300	280	66	
22	25	M3JP/KP 200 MLB	3GJP/KP 203 420-***G	983	91.6	91.6	0.81	43	7.5	214	3.2	3.2	0.43	320	300	61	
30	34	M3JP/KP 225 SMB	3GJP/KP 223 220-***G	985	92.8	92.8	0.81	58	7.4	291	3.4	3.0	0.64	385	365	61	
37	42	M3JP/KP 250 SMA	3GJP/KP 253 210-***G	987	93.4	93.4	0.81	71	7.2	358	3.2	2.9	1.16	455	435	66	
45	55	M3JP/KP 280 SMA	3GJP/KP 283 210-***G	990	94.4	94.3	0.84	82	7.0	434	2.5	2.5	1.85	705	625	66	
55	63	M3JP/KP 280 SMB	3GJP/KP 283 220-***G	990	94.6	94.6	0.84	101	7.0	531	2.7	2.6	2.2	745	665	66	
75	86	M3JP/KP 315 SMA	3GJP/KP 313 210-***G	992	95.0	94.7	0.82	141	7.4	722	2.4	2.8	3.2	930	850	70	
90	105	M3JP/KP 315 SMB	3GJP/KP 313 220-***G	992	95.5	95.3	0.84	163	7.5	866	2.4	2.8	4.1	1030	950	70	
110	125	M3JP/KP 315 SMC	3GJP/KP 313 230-***G	991	95.6	95.5	0.83	202	7.4	1060	2.5	2.9	4.9	1100	1020	70	
132	150	M3JP/KP 315 MLA	3GJP/KP 313 410-***G	991	95.8	95.7	0.83	240	7.5	1272	2.7	3.0	5.8	1250	1170	68	
160	195	M2JA/KA 355 S	3GJA/KA 353 100-***A	992	95.9	95.7	0.85	280	6.8	1540	1.8	2.7	10.4	1550	1550	75	
200	230	M2JA/KA 355 SMA	3GJA/KA 353 210-***A	992	95.9	95.7	0.85	355	7.1	1925	2.0	2.7	12.5	1800	1800	75	
250	300	M2JA/KA 355 SMB	3GJA/KA 353 220-***A	992	96.0	95.8	0.84	450	7.5	2407	2.2	2.8	12.5	1800	1800	75	
315	360	M2JA/KA 355 MLA	3GJA/KA 353 410-***A	991	96.2	96.1	0.84	565	7.3	3036	2.0	3.0	14.6	2100	2100	75	
355	400	M2JA/KA 355 MLC	3GJA/KA 353 430-***A	991	96.4	96.3	0.84	635	7.6	3421	1.5	3.0	15.8	2100	2100	78	
250	300	M2JA/KA 400 M	3GJA/KA 403 300-***A	992	96.0	95.8	0.84	450	7.5	2407	2.2	2.8	12.5	2000	2000	75	
315	360	M2JA/KA 400 MA	3GJA/KA 403 310-***A	991	96.2	96.1	0.84	565	7.3	3036	2.0	3.0	14.6	2150	2150	75	
355	400	M2JA/KA 400 MB	3GJA/KA 403 320-***A	991	96.4	96.3	0.84	635	7.6	3421	1.5	3.0	15.8	2150	2150	78	
400	450	M2JA/KA 400 LKA	3GJA/KA 403 510-***A	992	96.5	96.4	0.85	700	6.4	3851	1.2	2.7	16.5	2800	2800	80	
450	510	M2JA/KA 400 LKB	3GJA/KA 403 520-***A	993	96.5	96.4	0.85	790	6.8	4328	1.3	2.8	19	3050	3050	80	
500	560 ²⁾	M2JA/KA 400 LKC	3GJA/KA 403 530-***A	992	96.5	96.4	0.85	880	6.8	4813	1.3	2.8	19	3050	3050	80	

1000 r/min = 6 poles																	
400 V 50 Hz ¹⁾																	
High-output design																	
30	34	M3JP/KP 200 MLC	3GJP/KP 203 430-***G	983	91.6	91.5	0.80	60	7.5	292	3.5	3.4	0.49	340	320	65	
37	42	M3JP/KP 225 SMC	3GJP/KP 223 230-***G	983	92.8	92.9	0.83	70	7.1	359	3.2	2.8	0.75	415	395	64	
45	52	M3JP/KP 250 SMB	3GJP/KP 253 220-***G	986	93.7	93.7	0.82	85	7.2	436	3.3	2.8	1.49	500	480	65	
75	86	M3JP/KP 280 SMC	3GJP/KP 283 230-***G	990	95.1	95.2	0.84	137	7.3	723	2.8	2.7	2.85	825	745	66	

¹⁾ Motors are certified for the voltages 380-400-415 V 50 Hz according to IEC 60034-1. Values above are given for 400 V 50 Hz; data for other voltages on request.

Detailed data for 440 V 60 Hz on request.

²⁾ Temperature rise class F

ATEX certification process ongoing for frame sizes 355-400.

Notes:

- When ordering sizes 160-200 with lifetime lubrication, variant code 194 'ZZ bearings at both ends' has to be added
- When ordering IIC motors, following variant code has to be added: 461 = EEx d, EEx de design, Group IIC

Data for other voltages and frequencies, and for surface temperature T5 on request.

The two bullets in the product code indicate choice of mounting arrangement (see ordering information), voltage and frequency (below).

S	D	A ^{a)}	B ^{a)}	E	F ^{b)}	X
380 VY 50 Hz	380 VΔ 50 Hz	380 VY 50 Hz	380 VΔ 50 Hz	500 VΔ 50 Hz	500 VY 50 Hz	Other rated voltage, connection or frequency, max. 690 V
400 VY 50 Hz	400 VΔ 50 Hz	220 VΔ 50 Hz	660 VY 50 Hz	575 VΔ 60 Hz		
415 VY 50 Hz	415 VΔ 50 Hz					
220 VΔ 50 Hz	660 VY 50 Hz	G ^{a)}	H ^{a)}	T ^{b)}	U ^{b)}	
230 VΔ 50 Hz	690 VY 50 Hz	415 VY 50 Hz	415 VΔ 50 Hz	660 VΔ 50 Hz	690 VΔ 50 Hz	
440 VY 60 Hz	440 VΔ 60 Hz					

^{a)} On request for motor sizes 315-400.

^{b)} On request for motor sizes 355-400.

Technical data – Flameproof motors

EEx d IIB/IIC T4, EEx de IIB/IIC T4



IP 55, IC 411; Insulation class F, temperature rise class B

Output kW		Type designation	Product code	Speed r/min	Efficiency		Power factor cos φ	Current		Torque			Moment of inertia		Weight EE d	Sound pressure level L _p dB(A)
400V 50Hz	440V 60Hz				Full 100%	3/4- load 75%		I _N A	I _s A	T _N Nm	T _s Nm	T _{max} Nm	J=1/4 GD ² kgm ²	EE d		
750 r/min = 8 poles		400 V 50 Hz ¹⁾												Basic design		
0.18	0.22	M2JA/KA 80 LS	3GJA/KA 084 310-••B	700	53.2	49.0	0.47	1.1	3.4	2.5	3.5	3.6	0.002	24	24	36
0.25	0.3	M2JA/KA 80 L	3GJA/KA 084 320-••B	690	57.5	53.0	0.52	1.3	3.1	3.5	2.5	2.6	0.002	24	24	36
0.37	0.45	M2JA/KA 90 S	3GJA/KA 094 110-••B	700	61.0	56.0	0.56	1.7	3.0	5	2.0	2.2	0.0031	32	32	36
0.55	0.65	M2JA/KA 90 L	3GJA/KA 094 510-••B	695	62.7	59.0	0.54	2.4	3.0	7.6	2.0	2.3	0.0047	37	37	36
0.75	0.9	M2JA/KA 100 LA	3GJA/KA 104 510-••B	715	71.4	68.0	0.57	2.8	3.9	10.1	2.4	2.8	0.0069	44	44	44
1.1	1.3	M2JA/KA 100 LB	3GJA/KA 104 520-••B	705	71.7	69.0	0.61	3.8	3.8	15	2.1	2.6	0.0083	47	47	44
1.5	1.75	M2JA/KA 112 M	3GJA/KA 114 310-••B	700	73.4	72.8	0.61	4.9	3.8	20	2.3	2.5	0.01	51	51	46
2.2	2.5	M2JA/KA 132 S	3GJA/KA 134 110-••B	720	79.2	75.4	0.67	5.9	5.3	29.2	1.8	2.5	0.038	82	82	56
3	3.5	M2JA/KA 132 M	3GJA/KA 134 310-••B	720	80.0	79.0	0.68	7.8	5.5	39.8	2.4	2.6	0.045	96	96	56
4	4.6	M3JP/KP 160 MLA	3GJP/KP 164 410-••G	717	83.0	83.1	0.70	10.1	5.2	53	1.8	2.8	0.071	152	146	59
5.5	6.4	M3JP/KP 160 MLB	3GJP/KP 164 420-••G	715	84.1	84.6	0.70	13.9	5.2	73	1.9	2.8	0.09	166	160	53
7.5	8.6	M3JP/KP 160 MLC	3GJP/KP 164 430-••G	718	86.4	87.1	0.69	18.4	5.7	100	2.1	3.1	0.121	194	188	55
11	13	M3JP/KP 180 MLB	3GJP/KP 184 420-••G	724	89.9	90.0	0.72	24.5	5.7	145	1.7	2.7	0.239	233	227	63
15	17	M3JP/KP 200 MLA	3GJP/KP 204 410-••G	734	90.4	90.5	0.78	31	7.0	195	2.4	3.2	0.45	315	295	56
18.5	21	M3JP/KP 225 SMA	3GJP/KP 224 210-••G	734	90.5	90.5	0.73	41	6.1	241	2.2	3.0	0.61	370	350	55
22	25	M3JP/KP 225 SMB	3GJP/KP 224 220-••G	732	90.7	91.0	0.76	46	6.5	287	2.2	2.9	0.68	385	365	56
30	34	M3JP/KP 250 SMA	3GJP/KP 254 210-••G	735	92.0	92.1	0.78	61	6.7	390	2.0	2.9	1.25	455	435	56
37	43	M3JP/KP 280 SMA	3GJP/KP 284 210-••G	741	93.4	93.3	0.78	74	7.3	477	1.7	3.0	1.85	605	605	65
45	55	M3JP/KP 280 SMB	3GJP/KP 284 220-••G	741	94.0	93.8	0.78	90	7.6	580	1.8	3.1	2.2	745	665	65
55	63	M3JP/KP 315 SMA	3GJP/KP 314 210-••G	742	94.1	94.0	0.81	104	7.1	708	1.6	2.7	3.2	930	850	62
75	85	M3JP/KP 315 SMB	3GJP/KP 314 220-••G	741	94.4	94.3	0.82	141	7.1	968	1.7	2.7	4.1	1030	950	62
90	105	M3JP/KP 315 SMC	3GJP/KP 314 230-••G	741	94.8	94.7	0.82	167	7.4	1161	1.8	2.7	4.9	1100	1020	64
110	125	M3JP/KP 315 MLA	3GJP/KP 314 410-••G	740	95.0	95.0	0.83	203	7.3	1420	1.8	2.7	5.8	1250	1170	72
132	150	M2JA/KA 355 S	3GJA/KA 354 100-••A	742	95.0	94.9	0.80	250	5.8	1699	1.5	2.3	10.4	1550	1550	75
160	180	M2JA/KA 355 SMA	3GJA/KA 354 210-••A	742	95.2	95.1	0.80	305	6.3	2059	1.7	2.4	12.5	1800	1800	75
200	230	M2JA/KA 355 MLA	3GJA/KA 354 410-••A	743	95.5	95.1	0.77	395	6.6	2571	1.8	2.7	14.6	2100	2100	75
250	285	M2JA/KA 355 MLC	3GJA/KA 354 430-••A	744	95.7	95.4	0.80	470	6.6	3209	1.5	3.0	15.8	2100	2100	75
200	230	M2JA/KA 400 M	3GJA/KA 404 300-••A	743	95.5	95.1	0.77	395	6.6	2571	1.8	2.7	14.6	2150	2150	75
250	285	M2JA/KA 400 MA	3GJA/KA 404 410-••A	744	95.7	95.4	0.80	470	6.6	3209	1.5	3.0	15.8	2150	2150	75
315	360	M2JA/KA 400 LKA	3GJA/KA 404 510-••A	744	96.0	95.9	0.79	605	6.3	4043	1.4	2.6	16.5	2800	2800	80
355	400	M2JA/KA 400 LKB	3GJA/KA 404 530-••A	744	96.2	96.0	0.79	680	6.6	4557	1.5	2.7	19	3050	3050	80

750 r/min = 8 poles		400 V 50 Hz ¹⁾												High-output design		
18.5	21	M3JP/KP 200 MLB	3GJP/KP 204 420-••G	734	90.3	90.5	0.79	37.5	6.9	241	2.2	3.2	0.54	335	315	57
30	34 ²⁾	M3JP/KP 225 SMC	3GJP/KP 224 230-••G	731	90.3	90.7	0.76	63	6.3	392	2.3	3.0	0.75	410	390	59
37	42	M3JP/KP 250 SMB	3GJP/KP 254 220-••G	737	92.8	92.7	0.77	75	7.5	479	2.3	3.4	1.52	500	480	65
55	65	M3JP/KP 280 SMC	3GJP/KP 284 230-••G	741	94.4	94.3	0.80	105	7.9	709	1.9	3.1	2.85	825	745	65

¹⁾ Motors are certified for the voltages 380-400-415 V 50 Hz according to IEC 60034-1. Values above are given for 400 V 50 Hz; data for other voltages on request.

Detailed data for 440 V 60 Hz on request.

²⁾ Temperature rise class F

ATEX certification process ongoing for frame sizes 355-400.

Notes:

- When ordering sizes 160-200 with lifetime lubrication, variant code 194 '2Z bearings at both ends' has to be added
- When ordering IIC motors, following variant code has to be added: 461 = EEx d, EEx de design, Group IIC

Data for other voltages and frequencies, and for surface temperature T5 on request.

The two bullets in the product code indicate choice of mounting arrangement (see ordering information), voltage and frequency (below).

S	D	A ^{a)}	B ^{a)}	E	F ^{b)}	X
380 VY 50 Hz	380 VΔ 50 Hz	380 VY 50 Hz	380 VΔ 50 Hz	500 VΔ 50 Hz	500 VY 50 Hz	Other rated voltage, connection or frequency, max. 690 V
400 VY 50 Hz	400 VΔ 50 Hz	220 VΔ 50 Hz	660 VY 50 Hz	575 VΔ 60 Hz		
415 VY 50 Hz	415 VΔ 50 Hz					
220 VΔ 50 Hz	660 VY 50 Hz	G ^{a)}	H ^{a)}	T ^{b)}	U ^{b)}	
230 VΔ 50 Hz	690 VY 50 Hz	415 VY 50 Hz	415 VΔ 50 Hz	660 VΔ 50 Hz	690 VΔ 50 Hz	
440 VY 60 Hz	440 VΔ 60 Hz					

^{a)} On request for motor sizes 315-400.

^{b)} On request for motor sizes 355-400.

Technical data – Flameproof motors

EEx d IIB/IIC T4, EEx de IIB/IIC T4, two-speed



IP 55, IC 411; Insulation class F, temperature rise class B

Output kW	Motor type	Product code	Speed r/min	Current I _N	Weight kg
1500/1000 r/min = 4/6 poles		400 V 50 Hz		Fan drive, two separate windings	
0.95/0.28	M2JA/KA 90 S	3GJA/KA 098 304-••B	1390/950	2.3/1.1	32.5
1.25/0.4	M2JA/KA 90 L	3GJA/KA 098 514-••B	1410/955	3.0/1.3	37
1.8/0.55	M2JA/KA 100 LA	3GJA/KA 108 514-••B	1435/965	3.9/1.9	44
2.2/0.7	M2JA/KA 100 LB	3GJA/KA 108 524-••B	1435/970	4.7/2.4	47.5
2.6/0.8	M2JA/KA 112 M	3GJA/KA 118 314-••B	1425/970	5.3/2.8	51.5
4.5/1.5	M2JA/KA 132 S	3GJA/KA 138 114-••B	1460/985	8.8/4.9	79
6.0/2.0	M2JA/KA 132 M	3GJA/KA 138 314-••B	1460/980	11.5/5.4	82
11/3.7	M3JP/KP 160 MLC	3GJP/KP 168 434-••G	1467/973	22/9	172
15/4.7	M3JP/KP 160 MLE	3GJP/KP 168 454-••G	1465/972	29.5/11.5	195
18.5/5.8	M3JP/KP 180 MLC	3GJP/KP 188 434-••G	1476/984	35/15.2	239
21/6.6	M3JP/KP 200 MLB	3GJP/KP 208 424-••G	1474/989	38/14	320
26/8	M3JP/KP 200 MLC	3GJP/KP 208 434-••G	1474/987	47/16.7	340
31/10	M3JP/KP 225 SMB	3GJP/KP 228 224-••G	1481/991	55/21.5	385
40/12.5	M3JP/KP 225 SMC	3GJP/KP 228 234-••G	1481/989	71/26	415
54/17	M3JP/KP 250 SMB	3GJP/KP 258 224-••G	1480/987	97/38	505
85/27	M3JP/KP 280 SMB	3GJP/KP 288 224-••G	1487/992	160/59	765
100/30	M3JP/KP 280 SMC	3GJP/KP 288 234-••G	1486/991	180/62	825
120/36	M3JP/KP 315 SMB	3GJP/KP 318 224-••G	1487/991	212/72	1060
145/43	M3JP/KP 315 SMC	3GJP/KP 318 234-••G	1487/991	256/86	1100
180/54	M3JP/KP 315 MLA	3GJP/KP 318 414-••G	1484/990	321/109	1260
160/55	M2JA/KA 355 S	3GJA/KA 358 104-••A	1483/986	275/105	1550
240/85	M2JA/KA 355 SMA	3GJA/KA 358 214-••A	1487/988	410/160	1800
315/90	M2JA/KA 355 MLA	3GJA/KA 358 414-••A	1494/994	540/165	2100
315/90	M2JA/KA 400 M	3GJA/KA 408 304-••A	1494/994	540/165	2150
370/120	M2JA/KA 400 LKA	3GJA/KA 408 514-••A	1495/994	655/225	3050
3000/1500 r/min = 2 - 4 poles		400 V 50 Hz		Fan drive, Dahlander-connection	
0.95/0.2	M2JA/KA 80 L	3GJA/KA 088 328-••B	2750/1420	2.0/0.6	24
1.4/0.3	M2JA/KA 90 S	3GJA/KA 098 118-••B	2860/1460	3.0/1.0	32.5
1.9/0.4	M2JA/KA 90 L	3GJA/KA 098 518-••B	2880/1465	3.9/1.2	37
3/0.6	M2JA/KA 100 L	3GJA/KA 108 518-••B	2875/1460	7.5/2.4	44
3.7/0.75	M2JA/KA 112 M	3GJA/KA 118 318-••B	2900/1470	7.1/2.0	51.5
6.2/1.3	M2JA/KA 132 S	3GJA/KA 138 118-••B	2880/1455	11.3/3.4	79
8.3/1.7	M2JA/KA 132 M	3GJA/KA 138 128-••B	2875/1455	14.8/4.0	82
11/2.5	M3JP/KP 160 MLB	3GJP/KP 168 428-••G	2935/1471	20/4.9	172
14/3	M3JP/KP 160 MLC	3GJP/KP 168 438-••G	2931/1473	25.5/5.9	172
18.5/4	M3JP/KP 160 MLE	3GJP/KP 168 458-••G	2935/1473	33.5/7.7	195
22/5	M3JP/KP 180 MLB	3GJP/KP 188 428-••G	2954/1481	40/9.8	220
25/5.5	M3JP/KP 180 MLC	3GJP/KP 188 438-••G	2952/1480	44/10.5	239
34/8	M3JP/KP 200 MLC	3GJP/KP 208 438-••G	2951/1478	61/18	340
40/11	M3JP/KP 225 SMB	3GJP/KP 228 228-••G	2964/1480	69/23.5	400
50/14	M3JP/KP 225 SMC	3GJP/KP 228 238-••G	2962/1479	87/29.5	420
60/15.5	M3JP/KP 250 SMB	3GJP/KP 258 228-••G	2959/1480	104/33	500
90/30	M3JP/KP 280 SMB	3GJP/KP 288 228-••G	2965/1484	153/54	765
105/33	M3JP/KP 280 SMC	3GJP/KP 288 238-••G	2966/1483	186/60	825
125/25	M3JP/KP 315 SMB	3GJP/KP 318 228-••G	2972/1490	217/53	1040
175/45	M3JP/KP 315 MLA	3GJP/KP 318 418-••G	2980/1492	287/81	1260
190/45	M2JA/KA 355 S	3GJA/KA 358 108-••A	2987/1491	345/95	1550
200/50	M2JA/KA 355 SMA	3GJA/KA 358 218-••A	2987/1491	360/100	1750

ATEX certification process ongoing for frame sizes 355-400.

Notes:

- When ordering sizes 160-200 with lifetime lubrication, variant code 194 'ZZ bearings at both ends' has to be added
- When ordering IIC motors, following variant code has to be added: 461 = EEx d, EEx de design, Group IIC

Detailed technical data on request.

The two bullets in the product code indicate choice of mounting arrangement (see ordering information), voltage and frequency (next page).

Technical data – Flameproof motors

EEx d IIB/IIC T4, EEx de IIB/IIC T4, two-speed



IP 55, IC 411; Insulation class F, temperature rise class B

Output kW	Motor type	Product code	Speed r/min	Current I _N	Weight kg
1500/750 r/min = 4-8 poles		400 V 50 Hz		Fan drive, Dahlander-connection	
0.6/0.11	M2JA/KA 80 L	3GJA/KA 088 329-••B	1415/690	1.6/0.6	24
1/0.23	M2JA/KA 90 S	3GJA/KA 098 119-••B	1400/705	2.4/1.0	32.5
1.5/0.31	M2JA/KA 90 L	3GJA/KA 098 519-••B	1420/720	3.7/1.5	37
2/0.45	M2JA/KA 100 LA	3GJA/KA 108 519-••B	1425/720	4.3/1.7	44
2.4/0.5	M2JA/KA 100 LB	3GJA/KA 108 529-••B	1435/725	5.2/2.0	47.5
2.9/0.6	M2JA/KA 112 M	3GJA/KA 118 319-••B	1435/725	6.1/2.4	51.5
5.0/1.0	M2JA/KA 132 S	3GJA/KA 138 119-••B	1450/725	9.5/3.2	79
6.8/1.4	M2JA/KA 132 M	3GJA/KA 138 129-••B	1460/730	13.2/4.9	82
11/2.5	M3JP/KP 160 MLC	3GJP/KP 168 439-••G	1468/732	22/8.3	172
15/3.5	M3JP/KP 160 MLE	3GJP/KP 168 449-••G	1467/731	29/11	195
18.5/3.7	M3JP/KP 180 MLB	3GJP/KP 188 429-••G	1475/737	36/13.2	220
22/4.4	M3JP/KP 180 MLC	3GJP/KP 188 439-••G	1475/739	43/15.5	239
30/7	M3JP/KP 200 MLB	3GJP/KP 208 429-••G	1478/736	58/21	340
37/10	M3JP/KP 225 SMB	3GJP/KP 228 229-••G	1482/735	70/26.5	390
42/11	M3JP/KP 225 SMC	3GJP/KP 228 239-••G	1480/733	77/28.5	425
60/15	M3JP/KP 250 SMB	3GJP/KP 258 229-••G	1482/738	110/40	505
80/18.5	M3JP/KP 280 SMB	3GJP/KP 288 229-••G	1486/743	145/47	765
90/20	M3JP/KP 280 SMC	3GJP/KP 288 239-••G	1486/743	160/50	825
125/28	M3JP/KP 315 SMB	3GJP/KP 318 229-••G	1488/744	226/73	1060
160/37	M3JP/KP 315 MLA	3GJP/KP 318 419-••G	1486/742	283/93	1260
155/38	M2JA/KA 355 S	3GJA/KA 358 109-••A	1492/746	275/77	1550
175/44	M2JA/KA 355 SMA	3GJA/KA 358 219-••A	1492/743	305/90	1800
220/55	M2JA/KA 355 MLA	3GJA/KA 358 419-••A	1493/745	380/125	2100
220/55	M2JA/KA 400 M	3GJA/KA 408 309-••A	1493/745	380/125	2150
1500/1000 r/min = 4/6 poles		400 V 50 Hz		Constant torque, two separate windings	
0.8/0.4	M2JA/KA 90 S	3GJA/KA 099 304-••B	1415/960	2.1/1.6	32.5
1.0/0.6	M2JA/KA 90 L	3GJA/KA 099 514-••B	1425/950	2.5/2.1	37
1.5/0.9	M2JA/KA 100 LA	3GJA/KA 109 514-••B	1445/965	3.4/3.2	44
1.8/1.0	M2JA/KA 100 LB	3GJA/KA 109 524-••B	1450/965	4.2/3.3	47.5
2.2/1.2	M2JA/KA 112 M	3GJA/KA 119 314-••B	1445/965	4.8/3.8	51.5
3.3/2.2	M2JA/KA 132 S	3GJA/KA 139 114-••B	1420/980	7.1/6.4	79
4.5/3	M2JA/KA 132 M	3GJA/KA 139 314-••B	1470/980	9.3/8.0	82
7.5/5.5	M3JP/KP 160 MLC	3GJP/KP 169 434-••G	1474/972	15.2/13	172
11/7.7	M3JP/KP 160 MLE	3GJP/KP 169 454-••G	1470/971	22/18	195
14/9.5	M3JP/KP 180 MLC	3GJP/KP 189 434-••G	1479/984	27.5/24	239
18.5/13	M3JP/KP 200 MLB	3GJP/KP 209 424-••G	1476/985	34/26	320
22/15	M3JP/KP 200 MLC	3GJP/KP 209 434-••G	1477/985	40/29	340
28/19	M3JP/KP 225 SMB	3GJP/KP 229 224-••G	1481/985	50/38	385
34/23	M3JP/KP 225 SMC	3GJP/KP 229 234-••G	1481/986	60/45	415
45/30	M3JP/KP 250 SMB	3GJP/KP 259 224-••G	1483/984	85/64	505
65/43	M3JP/KP 280 SMB	3GJP/KP 289 224-••G	1485/988	117/87	765
76/50	M3JP/KP 280 SMC	3GJP/KP 289 234-••G	1487/989	137/101	825
90/60	M3JP/KP 315 SMB	3GJP/KP 319 224-••G	1490/991	165/125	1060
110/75	M3JP/KP 315 SMC	3GJP/KP 319 234-••G	1490/992	200/158	1100
140/95	M3JP/KP 315 MLA	3GJP/KP 319 414-••G	1489/990	250/190	1260

ATEX certification process ongoing for frame sizes 355-400.

Notes:

- When ordering sizes 160-200 with lifetime lubrication, variant code 194 '2Z bearings at both ends' has to be added
- When ordering IIC motors, following variant code has to be added: 461 = EEx d, EEx de design, Group IIC

Detailed technical data on request.

The two bullets in the product code indicate choice of mounting arrangement (see ordering information), voltage and frequency (below).

Motor	S	D	A	B	E	H	T	U	X
80-250	230V 50Hz	400V 50Hz	220V 50Hz	380V 50Hz	500V 50Hz	415V 50Hz	660V 50Hz	690 V 50 Hz	Other rated voltage
280-400	220-230V 50Hz 440-480V 60Hz	380-400V 50Hz	220V 50Hz	380V 50Hz	500V 50Hz 575V 60Hz	400-415V 50Hz 460-480V 60Hz			connection or freq. max. 690 V

Technical data – Flameproof motors

EEx d IIB/IIC T4, EEx de IIB/IIC T4, two-speed



IP 55, IC 411; Insulation class F, temperature rise class B

Output kW	Motor type	Product code	Speed r/min	Current I _N	Weight kg
3000/1500 r/min = 2-4 poles		400 V 50 Hz		Constant torque, Dahlander-connection	
0.95/0.6	M2JA/KA 80 L	3GJA/KA 089 328-••B	2750/1420	2.0/1.8	24
1.1/0.85	M2JA/KA 90 S	3GJA/KA 099 118-••B	2735/1405	2.4/2.1	32.5
1.5/1.25	M2JA/KA 90 L	3GJA/KA 099 518-••B	2800/1410	3.1/3.0	37
2.2/1.75	M2JA/KA 100 LA	3GJA/KA 109 518-••B	2815/1430	4.4/3.8	44
2.9/2.25	M2JA/KA 100 LB	3GJA/KA 109 528-••B	2850/1440	5.8/5.1	47.5
3.6/2.8	M2JA/KA 112 M	3GJA/KA 119 318-••B	2860/1440	7.0/6.1	51.5
4.7/3.1	M2JA/KA 132 SB	3GJA/KA 139 118-••B	2820/1420	8.8/7.4	79
7.2/4.8	M2JA/KA 132 M	3GJA/KA 139 128-••B	2870/1435	12.8/11.0	82
11/8	M3JP/KP 160 MLB	3GJP/KP 169 428-••G	2935/1466	20/15.3	172
14/10.5	M3JP/KP 160 MLC	3GJP/KP 169 438-••G	2931/1459	25.5/21	172
18.5/14	M3JP/KP 160 MLE	3GJP/KP 169 458-••G	2935/1460	33.5/27	195
22/16.5	M3JP/KP 180 MLB	3GJP/KP 189 428-••G	2954/1474	40/32	220
25/18.5	M3JP/KP 180 MLC	3GJP/KP 189 438-••G	2952/1472	44/35	239
31/22	M3JP/KP 200 MLB	3GJP/KP 209 428-••G	2952/1474	53/43	340
38/25	M3JP/KP 225 SMB	3GJP/KP 229 228-••G	2950/1476	67/56	400
45/29	M3JP/KP 225 SMC	3GJP/KP 229 238-••G	2950/1477	79/63	420
50/40	M3JP/KP 250 SMB	3GJP/KP 259 228-••G	2960/1482	83/71	505
90/65	M3JP/KP 280 SMB	3GJP/KP 289 228-••G	2965/1488	153/117	765
105/75	M3JP/KP 280 SMC	3GJP/KP 289 238-••G	2966/1486	186/136	825
125/85	M3JP/KP 315 SMB	3GJP/KP 319 228-••G	2972/1485	217/178	1040
175/120	M3JP/KP 315 MLA	3GJP/KP 319 418-••G	2980/1491	287/223	1260
170/125	M2JA/KA 355 S	3GJA/KA 359 108-••A	2980/1486	285/260	1550
180/150	M2JA/KA 355 SMA	3GJA/KA 359 218-••A	2983/1487	300/290	1750
220/165	M2JA/KA 355 MLA	3GJA/KA 359 418-••A	2985/1490	370/340	2150
220/165	M2JA/KA 400 M	3GJA/KA 409 308-••A	2985/1490	370/340	2200
1500/750 r/min = 4-8 poles		400 V 50 Hz		Constant torque, Dahlander-connection	
0.45/0.23	M2JA/KA 80 L	3GJA/KA 089 329-••B	1400/690	1.2/1.2	24
0.55/0.3	M2JA/KA 90 S	3GJA/KA 099 119-••B	1360/700	1.3/1.3	32.5
0.75/0.4	M2JA/KA 90 L	3GJA/KA 099 519-••B	1355/700	1.7/1.6	37
1.4/0.7	M2JA/KA 100 LA	3GJA/KA 109 519-••B	1425/710	3.1/2.8	44
1.8/0.9	M2JA/KA 100 LB	3GJA/KA 109 529-••B	1420/705	3.8/3.4	47.5
2.0/1.0	M2JA/KA 112 M	3GJA/KA 119 319-••B	1425/710	3.7/2.9	51.5
3.8/1.9	M2JA/KA 132 S	3GJA/KA 139 119-••B	1450/730	7.4/7.3	79
5/2.5	M2JA/KA 132 M	3GJA/KA 139 129-••B	1455/730	9.2/9.2	82
8/4.5	M3JP/KP 160 MLC	3GJP/KP 169 439-••G	1456/727	15.5/14.9	172
12/7	M3JP/KP 160 MLE	3GJP/KP 169 459-••G	1461/727	23/23.5	195
15/8	M3JP/KP 180 MLA	3GJP/KP 189 419-••G	1465/732	27/19	225
18.5/11	M3JP/KP 180 MLB	3GJP/KP 189 429-••G	1466/730	33/26	233
22/13	M3JP/KP 200 MLB	3GJP/KP 209 429-••G	1476/737	39/30	320
27/16	M3JP/KP 200 MLC	3GJP/KP 209 439-••G	1473/736	48/35.5	340
34/20	M3JP/KP 225 SMB	3GJP/KP 229 229-••G	1479/739	60/48	385
37/24	M3JP/KP 225 SMC	3GJP/KP 229 239-••G	1476/736	64/53	415
52/31	M3JP/KP 250 SMB	3GJP/KP 259 229-••G	1483/741	90/72	500
65/40	M3JP/KP 280 SMB	3GJP/KP 289 229-••G	1487/743	116/92	745
85/50	M3JP/KP 280 SMC	3GJP/KP 289 239-••G	1487/743	149/115	825
95/65	M3JP/KP 315 SMB	3GJP/KP 319 229-••G	1489/744	166/140	1030
115/80	M3JP/KP 315 SMC	3GJP/KP 319 239-••G	1489/743	198/167	1100
150/95	M3JP/KP 315 MLA	3GJP/KP 319 419-••G	1489/744	260/201	1250
150/90	M2JA/KA 355 S	3GJA/KA 359 109-••A	1491/741	260/195	1550
180/130	M2JA/KA 355 SMA	3GJA/KA 359 219-••A	1487/741	310/280	1800
210/160	M2JA/KA 355 MLA	3GJA/KA 359 419-••A	1489/742	360/355	2100
210/160	M2JA/KA 400 M	3GJA/KA 409 309-••A	1489/742	360/355	2150
250/185	M2JA/KA 400 LKA	3GJA/KA 409 519-••A	1493/745	435/485	3050

ATEX certification process ongoing for frame sizes 355-400.

Notes:

- When ordering sizes 160-200 with lifetime lubrication, variant code 194 '2Z bearings at both ends' has to be added
- When ordering IIC motors, following variant code has to be added: 461 = EEx d, EEx de design, Group IIC

Detailed technical data on request.

The two bullets in the product code indicate choice of mounting arrangement (see ordering information), voltage and frequency (see previous page).

Rating plates

For motor sizes 80 to 132 the rating plate gives one current value for the voltage area. That is the highest current that can occur within the voltage area with the given output.

For motor sizes 160 to 400 the rating plate is in table form giving values for speed, current and power factor for six voltage levels.

European standards require special marking on safety motors. The marking shall include the following:

- type of protection
- apparatus group
- temperature class
- name of certifying body
- certificate number

Motor sizes 80 to 132

ABB Oy, El.Machines LV Motors, Vaasa, Finland		No. 3399998	
3~ M2JA 132S4 EExd IIC T4 B3			
r/min 1450/1750		5.5/6.3 kW	
Cos φ 0.84/0.86		IP 55	Cl F K
V	380 - 415 Y	11.7	50
	220 - 240 D	20.2	50
	440 - 480 Y	11.0	60
3GJA 132101-ASB		79 kg	
6208-2Z/C3		IEC 60034-1	
LCIE 99 ATEX 6010 / 2000		IEC 60034-1	
CE 0081		Ex II 2G ABB	

Motor sizes 160 to 315

CE 0081		ABB Oy, Electrical Machines LV Motors, Vaasa, Finland	
3~Motor M3JP 200MLB 4 EExd IIB T4 B3			
IEC 200M/L 55			
S1		No. 3444646	
M7-1010-1		Ins.cl. F	IP 55
V	Hz	kW	r/min A cos φ Duty
690 Y	50	30	1475 32.5 0.84
400 D	50	30	1475 56 0.84
660 Y	50	30	1471 34 0.85
380 D	50	30	1471 59 0.85
415 D	50	30	1477 54 0.83
440 D	60	35	1769 59 0.85
Prod.code 3GJP202420-ADG			
LCIE 00 ATEX 6027			
6312/C3		6310/C3	340 kg
Ex II 2G		ABB IIB IIC 0034-1	

Motor sizes 355 to 400

ABB Oy, Electrical Machines LV Motors, Vaasa, Finland						
3~Motor M2JA 355MLB 4 EExd IIB T4 B3						
IEC 355S/M 100						
S1	No. 3425142					
VH-23224-1	Ins.cl. F IP 55					
V	Hz	kW	r/min	A	cos φ	Duty
690 Y	50	450	1489	445	0.87	
400 D	50	450	1489	770	0.87	
660 Y	50	450	1488	465	0.88	
380 D	50	450	1488	805	0.88	
415 D	50	450	1490	750	0.86	
440 D	60	500	1787	770	0.88	
Prod.code 3GJA352420-ADAA0001						
LCIE 94.C6001						
6322/C3	6319/C3 2100 kg					
Ex II 2G ABB IEC 60034-1						

Variant codes - Flameproof motors

Code	Variant codes / Flameproof motors 1)	Motor size			
		80- 132	160- 250	280- 315	355- 400
Balancing					
052	Balancing to grade R (ISO 2373).	P	P	P	P
417	Balancing to grade S (ISO 2373).	P	P	P	P
424	Full key balancing.	P	P	P	P
Bearings and lubrication					
036	Transport locking for bearings.	P	M	P	P
037	Roller bearing at D-end.	–	M	P	P
039	Cold resistant grease. For bearing temperatures -55...+100°C.	P	M	P	P
040	Heat resistant grease. Form bearing temperatures -25...+150°C.	M	S	S	S
041	Bearings regreasable via grease nipples.	–	S	S	S
194	2Z-bearings at both ends. Sizes 160-250 available as stocked option with lifetime bearings.	S	M	R	–
042	Locked drive-end	S	S	S	S
043	SPM-nipples.	–	S	S	S
058	Angular contact bearing at D-end.	–	R	R	R
107	Bearing mounted PT100 resistance elements. (only M2KA/Ex de)	–	P	P	P
433	Grease relief. (Not possible for flange-mounted sizes 160-180)	–	–	–	–
Brakes					
412	Built-on brake.	–	R	R	R
Branch standard designs					
142	"Manilla" winding connection. (440 VD series, 220 VD parallel, 60 Hz)	–	P	P	P
178	Stainless steel/acid proof bolts.	S	M	P	P
209	Non-standard voltage or frequency converter supply.	R	P	P	P
411	Increased efficiency design.	–	R	R	R
425	Corrosion protected stator and rotor core.	S	S	P	P
785	Reinforced tropicalisation.	P	P	S	S
Cooling system					
044	Unidirectional fan, clockwise seen from D-end.	–	–	R	R
045	Unidirectional fan, counter clockwise seen from D-end.	–	–	R	R
068	Metal fan.	P	P	P	P/S
075	Cooling method IC 418 (without fan).	R	P	P	P
183	Separate motor cooling (fan axial, N-end).	–	P	P	P
422	Separate motor cooling (fan top or side, N-end).	–	–	P	P
791	Stainless steel fan cover.	–	R	R	R
Coupling					
035	Assembly of customer supplied coupling-half.	M	M	M	M
Drain holes					
076	Draining holes with plugs.	–	P	P	P

1) Certain variant codes cannot be used simultaneously.

S = Included as standard.
M = On modification of a stocked motor,
or on new manufacture,
the number per order may be limited.

P = New manufacture only.
R = On request.
– = Not available

Code	Variant codes / Flameproof motors 1)	Motor size			
		80-132	160-250	280-315	355-400
Hazardous environments					
461	EEx d(e) design, Group IIC.	M	M	P	P
462	EEx d(e) design, temperature class T5.	P	R	R	R
463	EEx d(e) design, temperature class T6, up to frame size 250.	R	R	R	–
464	Alleinschutz -design. Certification of flameproof motor and protection device together.	R	R	R	R
Heating elements					
450	Heating element, 110-120 V.	M	M	M	M
451	Heating element, 220-240 V.	M	M	M	M
Insulation system					
014	Winding insulation class H.	–	R	P	P
405	Special winding insulation for frequency converter supply.	P	P	P	P
Mounting arrangements					
008	IM 2101 foot/flange mounted, IEC flange, from IM 1001 (B34 from B3).	P	–	–	–
009	IM 2001 foot/flange mounted, IEC flange, from IM 1001 (B35 from B3).	M	M	M	M
047	IM 3601 flange mounted, IEC flange, from 3001 (B14 from B5).	M	–	–	–
Noise reduction					
055	Noise reducing cover.	–	–	P	P
Painting					
114	Special paint colour, standard grade.	M	M	M	M
111	Offshore two-pack polyamide cured epoxy paint 160 µm.	–	P	P	P
115	Offshore, zinc primer painting.	–	P	P	P
179	Special paint specification.	R	R	R	R
Protection					
005	Protective roof, vertical motor, shaft down.	M	M	M	M
072	Radial seal at D-end. Sizes 80-132 only with flange-mounted motors.	M	M	M	M
073	Sealed against oil at D-end.	P	P	P	P
158	Degree of protection IP 65.	–	M	–	–
211	Weather protected, IP xxW.	P	P	P	P
401	Protective roof, horizontal motor.	–	–	P	P
403	Degree of protection IP 56.	M	M	P	P
404	Degree of protection IP 56, without fan.	–	P	P	P
783	Labyrinth sealing at D-end.	–	P	P	P
Rating & instruction plates					
002	Restamping voltage, frequency and output, continuous duty.	R	R	R	R
095	Restamping output (maintained voltage, frequency), intermittent duty.	–	–	–	–
138	Mounting of additional identification plate.	M	M	M	M
139	Additional identification plate delivered loose.	M	M	M	M
150	Instruction plates and maintenance in non-standard language.	R	R	R	R
161	Additional rating plate delivered loose.	M	M	M	M

1) Certain variant codes cannot be used simultaneously.

S = Included as standard.

M = On modification of a stocked motor,
or on new manufacture,
the number per order may be limited.

P = New manufacture only.

R = On request.
– = Not available

Code	Variant codes / Flameproof motors 1)	Motor size			
		80- 132	160- 250	280- 315	355- 400
Shaft & rotor					
069	Two shaft extensions as per basic catalogue.	P	P	P	P
070	One or two special shaft extensions, standard shaft material.	P	P	P	P
155	Cylindrical shaft extension, D-end, without key-way.	P	P	P	P
156	Cylindrical shaft extension, N-end, without key-way.	P	P	P	P
164	Shaft extension with closed key-way.	S	S	P	P
165	Shaft extension with open key-way.	P	P	S	S
410	Stainless/acid-proof steel shaft (standard or non-standard design).	R	R	P	P
431	Special shaft material for low temperatures, -40°C.	P	P	P	P
Standards and regulations					
152	Classified shaft material.	P	P	P	P
421	VIK design (Verband der industriellen Energie- und Kraftwirtschaft e.V).	P	P	P	P
773	EEMUA No 132 1988 design.	R	R	P	P
774	NORSOK (North Sea Territorial Waters) design.	R	R	P	P
775	SHELL DEP 33.66.05.31-Gen. January 1999 design.	M	M	P	P
Marine motors					
See catalogue "M3000 Marine motors, BA/Marine GB" for details.					
Stator winding temperature sensors					
121	Bimetal detectors, break type (NCC), (3 in series), 130°C in stator winding.	P	P	P	P
122	Bimetal detectors, break type (NCC), (3 in series), 150°C in stator winding.	P	P	P	P
125	Bimetal detectors, break type (NCC), (2X3 in series), 150°C in stator winding.	P	P	P	P
127	Bimetal detectors, break type (NCC), (3 in series 130°C & 3 in series 150°) in stator winding.	P	P	P	P
435	PTC - thermistors (3 in series), 130°C, in stator winding.	P	P	P	P
436	PTC - thermistors (3 in series), 150°C, in stator winding.	M	S	S	S
439	PTC - thermistors (2x3 in series), 150°C, in stator winding.	P	P	P	P
441	PTC - thermistors (3 in series 130°C & 3 in series 150°C), in stator winding.	P	P	P	P
445	PT100 resistance element (1 per phase) in stator winding.	P	P	P	P
446	PT100 resistance element (2 per phase) in stator winding.	R	P	P	P
Terminal box					
015	Δ-connection in terminal box (reconnection from Y).	M	M	M	M
017	Y-connection in terminal box (reconnection from Δ).	M	M	M	M
136	Extended cable connection, standard terminal box. M2AA motors: 2 m long connections cable.	R	R	R	R
137	Extended cable connection, low terminal box.	P	P	P	P
157	Terminal box degree of protection IP 65.	M	M	M	M
400	4 x 90 degr turnable terminal box. EEx de 160-180 = M	P	S/R	P	P
402	Terminal box adapted for AI -cables.	-	-	S	S
413	Extended cable connection, no terminal box.	-	-	R	R
418	Separate terminal box for temperature detectors.	-	P	P	P
466	Terminal box at N-end. Not possible for sizes 160-180.	-	R	R	R
468	Non-standard cable entry direction (please state cable direction).	P	P	P	P
469	Axial cable entry direction. EEx d = S, EEx de = R	R	S/R	R	R
730	Prepared for NPT cable glands.	P	P	P	P
731	Non-standard cable glands.	R	R	R	R

1) Certain variant codes cannot be used simultaneously.

S = Included as standard.
M = On modification of a stocked motor,
or on new manufacture,
the number per order may be limited.

P = New manufacture only.
R = On request.
- = Not available

Code	Variant codes / Flameproof motors 1)	Motor size			
		80-132	160-250	280-315	355-400
732	Standard cable gland EEx d IIB, armoured cable.	M	M	M	P
733	Standard cable gland EEx d IIB, non-armoured cable.	M	M	M	P
734	Standard cable gland EEx d IIC, armoured cable.	M	M	M	P
735	Standard cable gland EEx d IIC, non-armoured cable.	M	M	M	P
736	Standard cable gland EEx e, fulfilling EN 50014 and EN 50019. EEx de = S, EEx d = –	P	S/–	P	P
737	Standard cable gland EEx e, with clamping device, fulfilling EN 50014 and EN 50019. EEx de = L, EEx d = –	P	M/–	P	P
Testing					
145	Type test report from test of identical motor.	M	M	M	M
146	Type test with report for motor from specific delivery batch.	M	M	P	P
147	Type test with report for motor from specific delivery batch, customer witnessed.	M	M	P	P
148	Routine test report.	M	M	P	P
221	Type test and multi-point load test with report for motor from specific delivery batch. Complete type test with partial load test.	P	P	P	P
222	Torque/speed curve, type test and multi-point load test with report for motor from specific delivery batch. Complete type test without partial load test.	P	P	P	P
760	Vibration level test.	M	M	P	P
761	Vibration spectrum test.	–	P	P	P
762	Noise level test.	P	P	P	P
763	Noise spectrum test.	P	P	P	P
764	Complete test with ABB frequency converter.	P	P	P	P
768	Chog type test with report for motor from specific delivery batch.	R	P	R	R
769	Chog type test report from test of identical motor.	R	P	R	R
Variable speed drives					
181	Adapted for frequency converter, variable speed operation.	M	M	M	M
405	Special winding insulation for frequency converter supply, rated supply > 500 V.	P	P	P	P
701	Insulated bearing at N-end. Note: In Variable speed drives all Ex-motors size 280 and above must be equipped with insulated bearings.	–	R	P	P
704	EMC cable gland.	–	–	R	R
182	Separate motor cooling (fan axial, N-end).	–	P	P	P
422	Separate motor cooling (fan top or side, N-end).	–	–	P	P
476	Separate motor cooling (fan axial, N-end) and 1024 pulse tacho (Leine & Linde EEx e 840) mounted.	–	P	P	P
477	Separate motor cooling (fan axial, N-end) and 2048 pulse tacho (Leine & Linde EEx e 840) mounted.	–	P	P	P
747	EEx d pulse tacho.	–	P	P	P
Y/Δ-starting					
117	Terminals for Y/Δ start at both speeds (two-speed windings).	–	R	P	P
118	Terminals for Y/Δ start at high speed (two-speed windings).	–	R	P	P
119	Terminals for Y/Δ start at low speed (two-speed windings).	–	R	P	P

1) Certain variant codes cannot be used simultaneously.

S = Included as standard.
M = On modification of a stocked motor,
or on new manufacture,
the number per order may be limited.

P = New manufacture only.
R = On request.
– = Not available

Dimension drawings

M3000 Flameproof motors

Foot-mounted motor IM 1001, IM B3

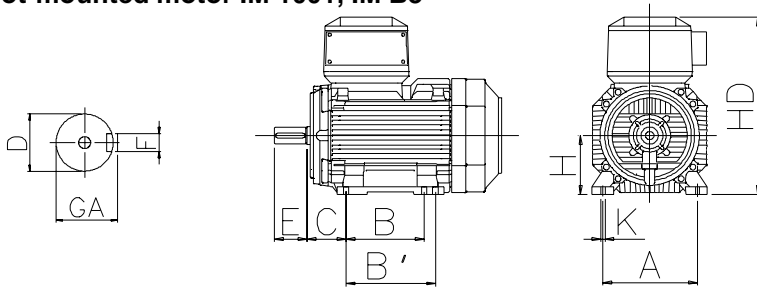

Motor with protection cover

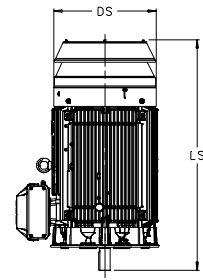

Flange-mounted motor IM 3001, IM B5

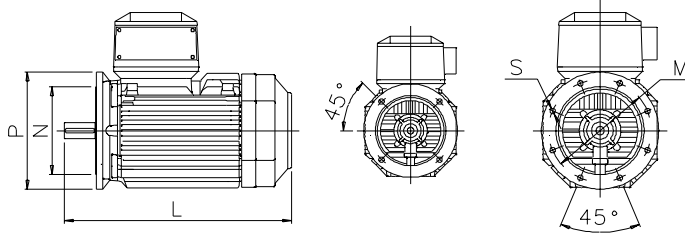

Sizes 80-200

Sizes 225-400

IM 1001, IM B3 AND IM 3001, IM B5						IM 1001, IM B3						IM 3001, IM B5				Protective roof									
Motor size	D poles		GA poles		F poles		E poles		L max poles	A	B	B'	C	HD		K	H	M	N	P	S	DS	LS	poles	
	2	4-8	2	4-8	2	4-8	2	4-8						M2JA	M2KA										2
80	19	19	21.5	21.5	6	6	40	40	287	287	125	100	-	50	251.5	250	10	80	165	130	200	12	150	306	306
90 S	24	24	27	27	8	8	50	50	336	336	140	100	125	56	276.5	275	10	90	165	130	200	12	170	360	360
90 L	24	24	27	27	8	8	50	50	336	336	140	100	125	56	276.5	275	10	90	165	130	200	12	170	360	360
100	28	28	31	31	8	8	60	60	399	399	160	140	-	63	295	294	10	100	215	180	250	15	188	444	444
112	28	28	31	31	8	8	60	60	419	419	190	140	-	70	307.5	306	12	112	215	180	250	15	188	444	444
132 S	38	38	41	41	10	10	80	80	512	512	216	140	178	89	352.5	351	12	132	265	230	300	15	255	548	548
132 M	38	38	41	41	10	10	80	80	512	512	216	140	178	89	352.5	351	12	132	265	230	300	15	255	548	548
160	42	42	45	45	12	12	110	110	711	711	254	210	254	108	447	388	14.5	160	300	250	350	18.5	328	756	756
180	48	48	51.5	51.5	14	14	110	110	706	706	279	241	279	121	485	426	14.5	180	300	250	350	18.5	359	756	756
200	55	55	59	59	16	16	110	110	774	774	318	267	305	133	616	573	18.5	200	350	300	400	18.5	414	844	844
225	55	60	59	64	16	18	110	140	841	871	356	286	311	149	663	620	18.5	225	400	350	450	18.5	462	921	951
250	60	65	64	69	18	18	140	140	875	875	406	311	349	168	726	683	24	250	500	450	550	18.5	506	965	965
280 SM_	65	75	69	79.5	18	20	140	140	1090	1090	457	368	419	190	862	768	24	280	500	450	550	18	555	1190	1190
315 SM_	65	80	69	85	18	22	140	170	1176	1206	508	406	457	216	929	858	30	315	600	550	660	23	624	1290	1320
315 ML_	65	90	69	95	18	25	140	170	1287	1317	508	457	508	216	929	858	30	315	600	550	660	23	624	1401	1431
355 S_	70	100	74.5	106	20	28	140	210	1344	1414	610	500	-	254	1150	985	35	355	740	680	800	23	590	1480	1550
355 SM_	70	100	74.5	106	20	28	140	210	1396	1466	610	500	560	254	1150	985	35	355	740	680	800	23	590	1530	1600
355 ML_	70	100	74.5	106	20	28	140	210	1501	1571	610	560	630	254	1150	985	35	355	740	680	800	23	590	1635	1705
400 M_	70	100	74.5	106	20	28	140	210	1501	1571	686	630	-	280	1195	1035	35	400	-	-	-	-	590	1635	1705
400 LK_	80	100	85	106	22	28	170	210	1708	1748	686	710	800	280	1240	1070	35	400	740	680	800	23	700	1860	1900

IM 3601, IM B14 - Available flange alternatives ; see also variant codes.

Flange size	Variant code	Flange dimensions				Motor size M2JA/M2KA					S = Standard flange R = Special flange NA = Not possible
		P	M	N	S	80	90	100	112	132	
FT100	258	120	100	80	M6	S	NA	NA	NA	NA	NA
FT115	260	140	115	95	M8	R	S	NA	NA	NA	NA
FT130	229	160	130	110	M8	R	R	S	S	NA	NA
FT165	236	200	165	130	M10	NA	NA	NA	NA	S	NA
FT215	246	250	215	180	M12	NA	NA	R	R	R	NA
FT265	256	300	265	230	M12	NA	NA	NA	NA	R	NA

Tolerances:

- A, B ± 0,8
- D, DA ISO k6 < Ø 50mm
- ISO m6 > Ø 50mm
- F, FA ISO h9
- H +0 -0,5
- N ISO j6
- C, CA ± 0,8

Above table gives the main dimensions in mm.

For detailed drawings please check our web-pages
'www.abb.com/motors&drives' or contact ABB.

Dimension drawings

Flameproof motors

Terminal boxes, standard with 6 terminals

Motor sizes 80-132

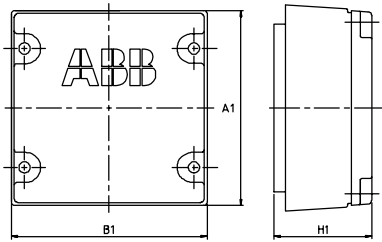

Motor sizes 160 - 250

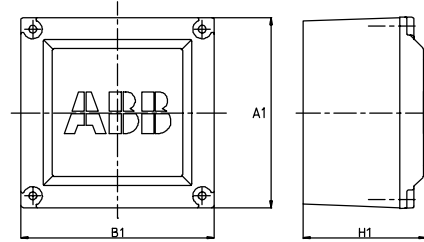

EEx d - motor sizes 280 - 315

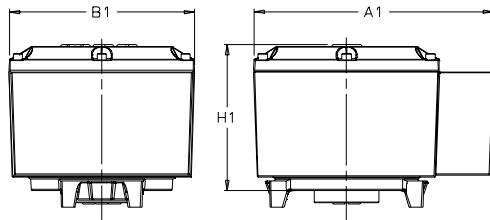

EEx d - motor sizes 355 - 400

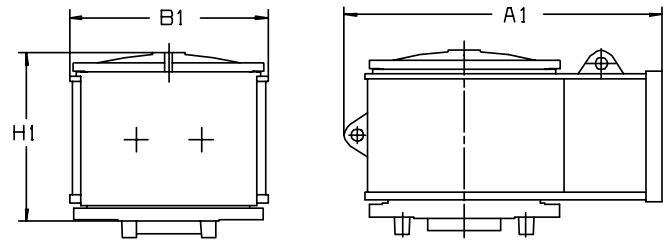

EEx de - motor sizes 280 - 315

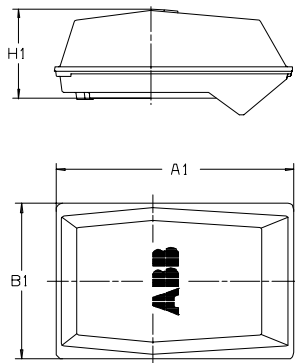

EEx de - motor sizes 355 - 400

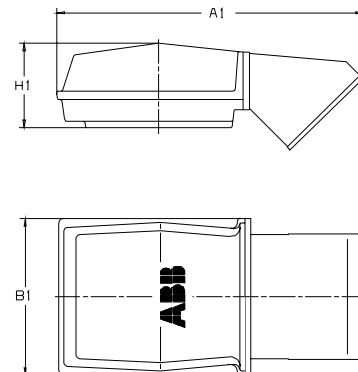

Motor size	Terminal box	A1	B1	H1
EEx d:				
80 - 132		164	162.5	68
160 - 180		234	234	111
200 - 250		339	290	226
280 - 315	M3JP/M2JA 142/2	465	370	260
355 - 400	M2JA 162/2 + Adapter MPMM-ZL1	790	490	420

For motor dimensions please see dimension drawings on earlier pages.

Motor size	Terminal box	A1	B1	H1
EEx de:				
80 - 132		175.5	174	70.5
160 - 180		234	234	51.5
200 - 250		352	319	183.5
280 - 315	M3KP/M2KA 142/2	536	350	197
355 - 400	M2KA 162/2 + Adapter MPMM-ZL1	787	410	226

Note: Smallest 355 sizes may be equipped with the 142/2 terminal box, for detail information contact us.

Flameproof motors EEx d, EEx de in brief, basic design

Motor size		80	90	100	112	132	160	180	
Stator	Material	Cast iron EN-GJL-200							
	Paint colour shade	Blue, Munsell 8B 4.5/3.25 (= NCS 4822-B05G)							
	Paint thickness	Alkyd paint, thickness $\geq 70 \mu\text{m}$					Two-pack epoxy paint, thickness $\geq 80 \mu\text{m}$		
Bearing end shields	Material	Cast iron EN-GJL-200							
	Paint colour shade	Blue, Munsell 8B 4.5/3.25 (= NCS 4822-B05G)							
	Paint thickness	Alkyd paint, thickness $\geq 70 \mu\text{m}$					Two-pack epoxy paint, thickness $\geq 80 \mu\text{m}$		
Bearings	D-end 2-pole	6204-2Z/C3	6205-2Z/C3	6206-2Z/C3	6206-2Z/C3	6208-2Z/C3	6309M/C3	6310M/C3	
	4-12 -pole						6309/C3	6310/C3	
	N-end 2-pole	6204-2Z/C3	6205-2Z/C3	6206-2Z/C3	6206-2Z/C3	6208-2Z/C3	6309M/C3	6309M/C3	
	4-12 -pole						6309/C3	6309/C3	
Axially-locked bearings	Inner bearing cover	As standard, locked at D-end							
Bearing seal		V-ring as standard, radial seal on request					Gamma-ring as standard, radial seal on request		
Lubrication		Permanent grease lubrication					Regreasable bearings as std, bearings greased for life as stock option		
SPM-nipples		–					As standard		
Rating plate	Material	Stainless steel							
Terminal box	Frame material	Cast iron EN-GJL-200					Cast Iron EN-GJL-200		
	Cover material	Cast iron EN-GJL-200					Cast Iron EN-GJL-200		
	Cover screws material	Acidproof steel (INOX)					Steel 5G, coated with zinc and yellow cromated		
Connections	Cable entries	1xM25x1.5	1xM25x1.5	1xM32x1.5	1xM32x1.5	1xM32x1.5	2xM40x1.5	2xM40x1.5	
	Terminals	6 terminals for connection with cable lugs (not included)							
Fan	Material	Reinforced glass fiber laminate					Reinforced glass fiber laminate or aluminium		
Fan cover	Material	Steel					Zinc coated steel		
	Paint colour shade	Blue, Munsell 8b 4.5/3.25 (= NCS 4822-B05G)							
	Paint thickness	Two-pack epoxy polyester paint, thickness $\geq 80 \mu\text{m}$					Two-pack polyester paint, thickness $\geq 80 \mu\text{m}$		
Stator winding	Material	Copper							
	Insulation	Insulation class F							
	Winding protection	On request					3 pcs thermistors as standard		
Rotor winding	Material	Pressure die-cast aluminium							
Balancing method		Half key balancing							
Key ways		Closed							
Drain holes		–					Optional		
Enclosure		IP 55, higher protection on request							
Cooling method		IC 411							
Mounting arrangements	Foot-mounted	IM B3 (IM1001), IM B6 (IM1051), IM B7 (IM1061), IM B8 (IM1071), IM V5 (IM1011), IM V6 (IM1031)							
	Flange-mounted	IM B5 (IM3001), IM V1 (IM3011), IM V3 (IM3031) IM B14 (IM3601), V18 (IM3611), V19 (IM3631)							
	Foot- and flange-m.	IM B34 (IM2101), IM B35 (IM2001), IM V15 (IM2011), IM V36 (IM2031)							

Flameproof motors EEx d, EEx de in brief, basic design

Motor size		200	225	250	280	315	355	400	
Stator	Material	Cast iron EN-GJL-200							
	Paint colour shade	Blue, Munsell 8B 4.5/3.25 (= NCS 4822-B05G)							
	Paint thickness	Two-pack epoxy paint, thickness $\geq 80 \mu\text{m}$			Two-pack epoxy paint, thickness $\geq 70 \mu\text{m}$				
Bearing end shields	Material	Cast iron EN-GJL-200					Spheroidal graphite EN-GJS-400		
	Paint colour shade	Blue, Munsell 8B 4.5/3.25 (= NCS 4822-B05G)							
	Paint thickness	Two-pack epoxy paint, thickness $\geq 80 \mu\text{m}$			Two-pack epoxy paint, thickness $\geq 70 \mu\text{m}$				
Bearings	D-end 2-pole	6312M/C3	6313M/C3	6315M/C3	6316/C3	6316/C3	6319M/C4	6319M/C4	
	4-12 -pole	6312/C3	6313/C3	6315/C3	6316/C3	6319/C3	6322/C3	6322/C3	
	N-end 2-pole	6310M/C3	6312M/C3	6313M/C3	6316/C3	6316/C3	6319M/C4	6319M/C4	
	4-12 -pole	6310/C3	6312/C3	6313/C3	6316/C3	6316/C3	6319/C3	6319/C3	
Axially-locked bearings	Inner bearing cover	As standard, locked at D-end							
Bearing seals		Gamma-ring as standard, radial seal on request			V-ring as standard, radial seal on request				
Lubrication		Regreasable bearings as standard, bearings greased for life as stock option			Regreasable bearings. regreasing nipples, M10x1				
SPM-nipples		As standard			Optional		As standard		
Rating plate	Material	Stainless steel							
Terminal box	Frame material	Cast iron EN-GJL-200					Cast iron EN-GJL-150		
	Cover material	Cast iron EN-GJL-200					or steel		
	Cover screws material	Steel 5G, coated with zinc and yellow cromated							
Connections	Cable entries	2xM50x1.5	2xM50x1.5	2xM50x1.5 ¹⁾	2xM63x1.5	2xM63x1.5	2xM80x1.5	2xM80x1.5	
	Terminals	6 terminals for connection with cable lugs (not included) ¹⁾ for EEX de motors 2xM63x1.5							
Fan	Material	Reinforced glass fiber laminate or aluminium			Reinforced glass fiber laminate, aluminium or polypropylene with metal hub				
Fan cover	Material	Zinc coated steel			Steel				
	Paint colour shade	Blue, Munsell 8B 4.5/3.25 (= NCS 4822-B05G)							
	Paint thickness	Two-pack polyester paint, thickness $\geq 80 \mu\text{m}$			Two-pack epoxy polyester paint, thickness $\geq 80 \mu\text{m}$				
Stator winding	Material	Copper							
	Insulation	Insulation class F							
	Winding protection	3 pcs thermistors as standard							
Rotor winding	Material	Pressure die-cast aluminium			Pressure die-cast aluminium or copper				
Balancing method		Half key balancing							
Key ways		Closed			Open				
Drain holes		Optional							
Enclosure		IP 55, higher protection on request							
Cooling method		IC 411							
Mounting arrangements	Foot-mounted	IM B3 (IM1001), IM B6 (IM1051), IM B7 (IM1061), IM B8 (IM1071), IM V5 (IM1011), IM V6 (IM1031)							
	Flange-mounted	IM B5 (IM3001), IM V1 (IM3011), IM V3 (IM3031) Note: Motor size 400 LK_ IM B5 and V3 on request.							
	Foot- and flange-m.	IM B35 (IM2001), IM V15 (IM2011), IM V36 (IM2031)							

Increased safety EEx e

Range

	Standards	Frame	Size	Output range
Increased safety EEx e	EN 50014, EN 50019	aluminium	90 - 250	1.1 - 53 kW
		cast iron	80 - 400	0.55 - 350 kW

Terminal boxes

Terminal boxes are mounted on the top of all basic motor versions. The terminal box can also be placed on either side of the motor besides on cast iron 160 to 250 motors. The terminal box is either rotatable or at least allows cable entry from either side which gives a choice of connection possibilities.

Protection class of the standard terminal box is IP 55.

Aluminium motors

In sizes 90 to 180 the terminal box is made of aluminium, the bottom section is integrated with the stator and provided with two openings on both sides. Cable glands are not supplied.

In sizes 200 to 250 the terminal box and cover are

made of deep drawn steel, bolted to the stator. The terminal box is provided with two flange openings, one on each side. Cable glands are not supplied.

Cast iron motors

The terminal boxes in motors 71-132 and 200-250 are 4x90° turnable as standard, in motor sizes 160 to 180 and 280-400 as standard 2x180° and as easy option 4x90°.

In sizes 80 to 132 the motors are provided with cast iron terminal boxes with tapped cable entry holes on one side. Cable glands are not supplied in motor sizes 80-132. In motor sizes 160 to 400 the cast iron terminal box is equipped with cable glands or cable boxes as standard.

Co-ordination of terminal boxes and cable entries

If no ordering information on the cable is given, it is assumed to be p.v.c. -insulated. Termination parts are supplied according to the tables below.

For aluminium motors 90-180 and cast iron motors 160-400 metric threads are available as standard.

Motor sizes 90-250 with aluminium frame

Voltage 220 - 690 V, 50 Hz

Motor size	Opening	Metric cable entry	Comparison Pg gland	Cable diameter mm, min-max.	Max. connection cable area mm ²	Terminal bolt size 6 x
90-100	¹⁾	4 x M20	4 x Pg 16	2x Ø8-13	4	M4
112-132	¹⁾	M25 + M20	2 x (Pg 21 + Pg 16)	2x Ø11-17	10	M5
160-180	¹⁾	2 x M40 + M12	4 x Pg 29 + 2 x Pg 9	2x Ø19-27	35	M6
200-250	2 x FL 13	2 x M63 + M12	2 x Pg 29	2x Ø19-27	70	M10

¹⁾ Knockout openings

Motor sizes 80-250 with cast iron frame

Motor size	Metric cable entry	Comparison Pg gland	Cable gland diameter mm, min-max.	Max. connection cable area mm ²	Terminal bolt size 6 x
80-90	2 x M25 x 1.5	2 x Pg 16	2x Ø8-13	6	M4
100-112	2 x M32 x 1.5	2 x Pg 21	2x Ø15-20	16	M5
132	2 x M32 x 1.5	2 x Pg 21	2x Ø15-20	16	M5
160	2 x M40 x 1.5 + 2 x M20 x 1.5	2 x Pg 29 + 2 x Pg 13.5	2x Ø18-27	25	M6
180	2 x M40 x 1.5 + 2 x M20 x 1.5	2 x Pg 29 + 2 x Pg 13.5	2x Ø18-27	25	M6
200	2 x M50 x 1.5 + 2 x M20 x 1.5	2 x Pg 36 + 2 x Pg 13.5	2x Ø26-35	35	M10
225	2 x M50 x 1.5 + 2 x M20 x 1.5	2 x Pg 36 + 2 x Pg 13.5	2x Ø26-35	50	M10
250	2 x M63 x 1.5 + 2 x M20 x 1.5	2 x Pg 42 + 2 x Pg 13.5	2x Ø32-49	70	M10

Co-ordination of terminal boxes and cable entries

Cast iron motors sizes 280-400 motors with top-mounted terminal box

Motor size	Flange or adapter	Cable box or cable gland	Gland thread	Cable diameter	Max. connection cable area mm ²	Terminal bolt size	Voltage/frequency code
3000 r/min (2 poles)							
280	3GZF 294 730-749	2x 3GZF 294 730-613	2x M63x1.5	2x Ø32-49	2x150	M12	
315	3GZF 294 730-753	2x 3GZF 294 730-613	2x M63x1.5	2x Ø32-49	2x240	M12	
355 S	MPMM-ZL1	3GZF 294 730-301		2x Ø48-60	4x240	M12	D
	-	3GZF 294 730-301		2x Ø48-60	2x240	M12	E
355 SM_	MPMM-ZL1	3GZF 294 730-301		2x Ø48-60	4x240	M12	
355 ML_	MPMM-ZL1	LNPB 3328		2x Ø60-80	4x240	M12	
400 M_	MPMM-ZL1	LNPB 3328		2x Ø60-80	4x240	M12	
400 LK_	MPMM-ZL1	LNPB 3328		2x Ø60-80	4x240	M12	
1500 r/min (4 poles)							
280	3GZF 294 730-749	2x 3GZF 294 730-613	2x M63x1.5	2x Ø32-49	2x150	M12	
315	3GZF 294 730-753	2x 3GZF 294 730-613	2x M63x1.5	2x Ø32-49	2x240	M12	
355 S	MPMM-ZL1	3GZF 294 730-301		2x Ø48-60	4x240	M12	D
	-	3GZF 294 730-301		2x Ø48-60	2x240	M12	E
355 SM_	MPMM-ZL1	3GZF 294 730-301		2x Ø48-60	4x240	M12	
355 ML_	MPMM-ZL1	LNPB 3328		2x Ø60-80	4x240	M12	
400 M_	MPMM-ZL1	LNPB 3328		2x Ø60-80	4x240	M12	
400 LKA	MPMM-ZL1	LNPB 3328		2x Ø60-80	4x240	M12	D
	MPMM-ZL1	LNPB 3328		2x Ø60-80	4x240	M12	E
400 LKB, LKC	MPMM-ZL1	LNPB 3328		2x Ø60-80	4x240	M12	
1000 r/min (6 poles)							
280	3GZF 294 730-749	2x 3GZF 294 730-613	2x M63x1.5	2x Ø32-49	2x150	M12	
315	3GZF 294 730-753	2x 3GZF 294 730-613	2x M63x1.5	2x Ø32-49	2x240	M12	
355 S, SMA	-	3GZF 294 730-301		2x Ø48-60	2x240	M12	
355 SMB	MPMM-ZL1	3GZF 294 730-301		2x Ø48-60	4x240	M12	D
	-	3GZF 294 730-301		2x Ø48-60	2x240	M12	E
355 ML_	MPMM-ZL1	3GZF 294 730-301		2x Ø48-60	4x240	M12	
400 M	MPMM-ZL1	LNPB 3328		2x Ø60-80	4x240	M12	D
	-	3GZF 294 730-301		2x Ø48-60	2x240	M12	E
400 MA, MB	MPMM-ZL1	LNPB 3328		2x Ø60-80	4x240	M12	
400 LKA	MPMM-ZL1	LNPB 3328		2x Ø60-80	4x240	M12	
400 LKB, LKC	MPMM-ZL1	LNPB 3328		2x Ø60-80	4x240	M12	D
	MPMM-ZL1	LNPB 3328		2x Ø60-80	4x240	M12	E
750 r/min (8 poles)							
280	3GZF 294 730-749	2x 3GZF 294 730-613	2x M63x1.5	2x Ø32-49	2x150	M12	
315	3GZF 294 730-753	2x 3GZF 294 730-613	2x M63x1.5	2x Ø32-49	2x240	M12	
355 S, SMA	-	3GZF 294 730-301		2x Ø48-60	2x240	M12	
355 MLA	-	3GZF 294 730-301		2x Ø48-60	2x240	M12	
355 MLC	MPMM-ZL1	3GZF 294 730-301		2x Ø48-60	4x240	M12	D
	-	3GZF 294 730-301		2x Ø48-60	2x240	M12	E
400 M	-	3GZF 294 730-301		2x Ø48-60	2x240	M12	D
400 MA	MPMM-ZL1	3GZF 294 730-301		2x Ø48-60	4x240	M12	D
	-	3GZF 294 730-301		2x Ø48-60	2x240	M12	E
400 LK_	MPMM-ZL1	LNPB 3328		2x Ø60-80	4x240	M12	

Voltage/frequency codes:

D - 380-420 VΔ 50 Hz, 660-690 VY 50 Hz, 440-480 VΔ 60 Hz

E - 500 VΔ 50 Hz, 575 VΔ 60 Hz

Examples:

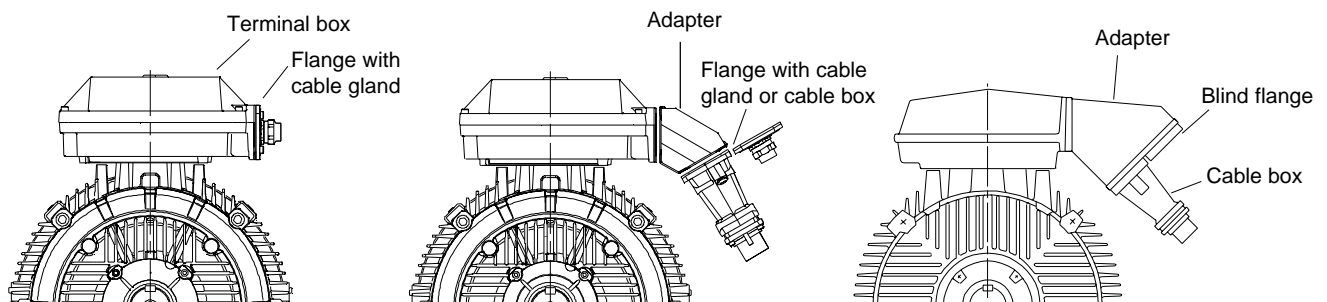

Co-ordination of terminal boxes and cable entries

Cast iron motors sizes 280-400 motors with side-mounted terminal box

Motor size	Flange or adapter	Cable box or cable gland	Gland thread	Cable diameter	Max. connection cable area mm ²	Terminal bolt size	Voltage/frequency code
3000 r/min (2 poles)							
280	3GZF 294 730-749	2x 3GZF 294 730-613	2x M63x1.5	2x Ø32-49	2x150	M12	
315	3GZF 294 730-753	2x 3GZF 294 730-613	2x M63x1.5	2x Ø32-49	2x240	M12	
355 S	3GZF 294 730-759	3GZF 294 730-301		2x Ø48-60	4x240	M12	D
	-	3GZF 294 730-301		2x Ø48-60	2x240	M12	E
355 SM_	3GZF 294 730-759	3GZF 294 730-301		2x Ø48-60	4x240	M12	
355 ML_	3GZF 294 730-759	LNPB 3328		2x Ø60-80	4x240	M12	
400 M_	3GZF 294 730-759	LNPB 3328		2x Ø60-80	4x240	M12	
400 LK_	3GZF 294 730-759	LNPB 3328		2x Ø60-80	4x240	M12	
1500 r/min (4 poles)							
280	3GZF 294 730-749	2x 3GZF 294 730-613	2x M63x1.5	2x Ø32-49	2x150	M12	
315	3GZF 294 730-753	2x 3GZF 294 730-613	2x M63x1.5	2x Ø32-49	2x240	M12	
355 S	3GZF 294 730-759	3GZF 294 730-301		2x Ø48-60	4x240	M12	D
	-	3GZF 294 730-301		2x Ø48-60	2x240	M12	E
355 SM_	3GZF 294 730-759	3GZF 294 730-301		2x Ø48-60	4x240	M12	
355 ML_	3GZF 294 730-759	LNPB 3328		2x Ø60-80	4x240	M12	
400 M_	3GZF 294 730-759	LNPB 3328		2x Ø60-80	4x240	M12	
400 LKA	3GZF 294 730-759	LNPB 3328		2x Ø60-80	4x240	M12	D
	3GZF 294 730-759	LNPB 3328		2x Ø60-80	4x240	M12	E
400 LKB, LKC	3GZF 294 730-759	LNPB 3328		2x Ø60-80	4x240	M12	
1000 r/min (6 poles)							
280	3GZF 294 730-749	2x 3GZF 294 730-613	2x M63x1.5	2x Ø32-49	2x150	M12	
315	3GZF 294 730-753	2x 3GZF 294 730-613	2x M63x1.5	2x Ø32-49	2x240	M12	
355 S	-	3GZF 294 730-301		2x Ø48-60	2x240	M12	
355 SMB	3GZF 294 730-759	3GZF 294 730-301		2x Ø48-60	4x240	M12	D
	-	3GZF 294 730-301		2x Ø48-60	2x240	M12	E
355 MLA	3GZF 294 730-759	3GZF 294 730-301		2x Ø48-60	4x240	M12	
400 M	3GZF 294 730-759	LNPB 3328		2x Ø60-80	4x240	M12	D
	-	3GZF 294 730-301		2x Ø48-60	2x240	M12	E
400 MA, MB	3GZF 294 730-759	LNPB 3328		2x Ø60-80	4x240	M12	
400 LKA	3GZF 294 730-759	LNPB 3328		2x Ø60-80	4x240	M12	
400 LKB, LKC	3GZF 294 730-759	LNPB 3328		2x Ø60-80	4x240	M12	D
	3GZF 294 730-759	LNPB 3328		2x Ø60-80	4x240	M12	E
750 r/min (8 poles)							
280	3GZF 294 730-749	2x 3GZF 294 730-613	2x M63x1.5	2x Ø32-49	2x150	M12	
315	3GZF 294 730-753	2x 3GZF 294 730-613	2x M63x1.5	2x Ø32-49	2x240	M12	
355 S	-	3GZF 294 730-301		2x Ø48-60	2x240	M12	
355 MLA	-	3GZF 294 730-301		2x Ø48-60	2x240	M12	
355 MLC	3GZF 294 730-759	3GZF 294 730-301		2x Ø48-60	4x240	M12	D
	-	3GZF 294 730-301		2x Ø48-60	2x240	M12	E
400 M	-	3GZF 294 730-301		2x Ø48-60	2x240	M12	D
400 MA	3GZF 294 730-759	3GZF 294 730-301		2x Ø48-60	4x240	M12	D
	-	3GZF 294 730-301		2x Ø48-60	2x240	M12	E
400 LK_	3GZF 294 730-759	LNPB 3328		2x Ø60-80	4x240	M12	

Voltage/frequency codes:

D - 380-420 VΔ 50 Hz, 660-690 VY 50 Hz, 440-480 VΔ 60 Hz

E - 500 VΔ 50 Hz, 575 VΔ 60 Hz

Examples:

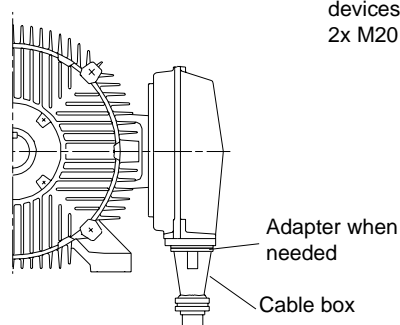
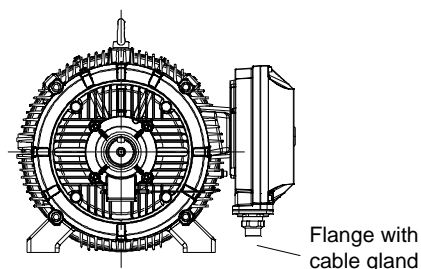

Auxiliary devices (view from N-end):

Cable glands for auxiliary devices as standard
2x M20 x 1.5

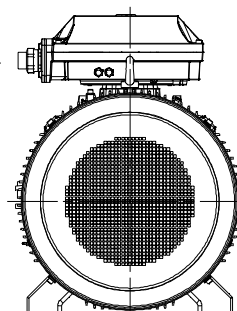

Technical data – Increased safety motors

EEx e II T3, Aluminium frame, sizes 90 to 250



IP 55, IC 411; Insulation class F, temperature rise class B

Output kW	Type designation	Product code	Speed r/min	Efficiency	Power	Current		Torque			Time tE sec	Moment of inertia J=1/4 GD ² kgm ²	Weight kg	Sound pressure level LP dB(A)
				FL 100%	factor cos φ	I _N A	I _s I _N	T _N Nm	T _s T _N	T _{max} T _N				
3000 r/min = 2 poles														
400 V 50 Hz														
1.5	M3AAL 90 S	3GAA 091 001-••A	2870	80.1	0.82	3.35	5.5	5	2.4	3.0	9	0.0019	13	63
2.2	M3AAL 90 L	3GAA 091 002-••A	2880	83.6	0.87	4.37	7.0	7.5	2.7	3.0	8	0.0024	16	63
3	M3AAL 100 L	3GAA 101 001-••A	2900	86.0	0.88	5.95	7.5	10	2.7	3.6	7	0.0041	21	65
3.5	M2AA 112 M	3GAA 111 001-••A	2890	86.0	0.90	6.5	8.8	11.6	3.2	3.5	5	0.01	25	63
4.5	M2AA 132 SB	3GAA 131 002-••A	2890	87.0	0.91	8.3	9.0	14.9	3.6	3.8	5	0.016	42	69
11	M2AA 160 MA	3GAA 161 101-••A	2930	91.2	0.88	20	6.6	36	1.9	2.5	11	0.039	73	69
15 ¹⁾	M2AA 160 M	3GAA 161 102-••A	2920	91.7	0.90	26.5	6.6	49	2.3	2.5	5.5	0.047	84	69
16	M2AA 160 L	3GAA 161 103-••A	2930	92.4	0.90	28	8.3	52	3.0	3.1	6	0.053	94	69
19	M2AA 180 M	3GAA 181 101-••A	2950	92.8	0.88	33	8.5	62	2.9	3.1	6	0.077	119	69
24	M2AA 200 MLA	3GAA 201 001-••A	2955	92.7	0.89	42	7.7	78	2.4	3.1	6.5	0.15	175	72
27	M2AA 200 MLB	3GAA 201 002-••A	2955	92.1	0.90	47	8.4	87	2.8	3.6	5.5	0.18	200	72
43	M2AA 225 SMB	3GAA 221 001-••A	2955	93.2	0.90	74	6.3	139	2.1	2.4	6.5	0.26	235	74
48	M2AA 250 SMA	3GAA 251 001-••A	2970	93.9	0.90	82	7.3	154	1.9	2.8	9	0.49	285	75
52	M2AA 250 SMB	3GAA 251 002-••A	2980	95.9	0.90	87	9.3	167	2.5	3.5	6.5	0.57	330	75
1500 r/min = 4 poles														
400 V 50 Hz														
1.1	M3AAL 90 S	3GAA 092 001-••A	1410	77.5	0.81	2.59	5.0	7.5	2.2	2.7	12	0.0032	13	50
1.5	M3AAL 90 L	3GAA 092 002-••A	1420	80.3	0.79	3.45	5.0	10	2.4	2.9	16	0.0043	16	50
2.2	M3AAL 100 LA	3GAA 102 001-••A	1430	83.0	0.81	4.8	5.5	15	2.4	2.9	11	0.0069	21	64
3	M3AAL 100 LB	3GAA 102 002-••A	1430	85.0	0.81	6.48	5.5	20	2.5	2.9	6	0.0082	24	66
4 ¹⁾	M2AA 112 M	3GAA 112 001-••A	1430	85.0	0.80	8.7	6.9	27	2.9	3.1	7	0.015	27	56
5.5 ¹⁾	M2AA 132 S	3GAA 132 001-••A	1450	87.0	0.83	10.9	7.3	36	2.2	3.0	9	0.031	40	59
7.5 ¹⁾	M2AA 132 M	3GAA 132 002-••A	1450	88.0	0.83	14.8	7.8	49	2.5	3.2	6	0.038	48	59
11 ¹⁾	M2AA 160 M	3GAA 162 101-••A	1460	90.3	0.81	21.5	6.5	72	2.9	2.8	10	0.067	75	62
15 ¹⁾	M2AA 160 L	3GAA 162 102-••A	1455	91.1	0.84	28.5	7.4	98	3.0	2.8	10	0.091	94	62
17 ¹⁾	M2AA 160 LB	3GAA 162 103-••A	1450	90.5	0.84	32	7.2	112	3.2	3.2	8	0.102	103	63
18.5 ¹⁾	M2AA 180 M	3GAA 182 101-••A	1470	92.3	0.84	35	6.8	120	3.1	2.7	13	0.161	124	62
22 ¹⁾	M2AA 180 L	3GAA 182 102-••A	1470	92.4	0.84	41	6.8	143	2.9	2.8	7.5	0.191	141	63
26	M2AA 180 LB	3GAA 182 103-••A	1470	92.5	0.82	49	8.2	169	3.7	3.2	5.5	0.225	161	63
26	M2AA 200 MLA	3GAA 202 001-••A	1470	92.7	0.84	49	6.5	169	2.4	2.6	6	0.29	180	63
35	M2AA 225 SMB	3GAA 222 002-••A	1480	94.3	0.85	63	7.5	226	2.8	2.7	9	0.37	215	66
39	M2AA 225 SMC	3GAA 222 003-••A	1480	94.9	0.86	69	7.7	252	3.5	3.2	7	0.42	230	66
46	M2AA 250 SMA	3GAA 252 001-••A	1480	94.2	0.86	82	7.0	297	2.2	2.7	6.5	0.72	275	67
53	M2AA 250 SMB	3GAA 252 002-••A	1480	94.5	0.87	93	7.6	342	2.8	3.4	6.5	0.88	335	67

¹⁾ Temperature rise class F.

Note: M2AA stocked motors cannot be restamped for 440 V 60 Hz; available during new production. Stocked motors with voltage code S and D can be restamped for 460 VY and voltage code D for 460 VD; except 2-pole type M2AA 132 SB and 2- and 4-pole M2AA 200-250 motors which need special winding.
When placing orders for frame sizes 90-100, the variant code +273 should be added.

ATEX certification process ongoing for frame sizes 112-250.

During the transition period some motor types belonging to M3000 range still have the old product codes and type designations. Always check the valid code before ordering.

The two bullets in the product code indicate choice of mounting arrangement (see ordering information), voltage and frequency (below).

Motor size	S		D		H	E	F	T	U	X
	50 Hz	60 Hz	50 Hz	60 Hz						
90-100	220-230 VΔ 380-400 VY	–	380-400 VΔ	–	415 VΔ ^{a)}	500 VΔ	500 VY	–	–	Other rated voltage, connection or frequency, 690 V maximum (500 V maximum for frame sizes 90-100)
112-250	230 VΔ	460 VY 400 VY	400 VΔ	460 VΔ 690 VY	415 VΔ	500 VΔ	–	660 VΔ	690 VΔ	

^{a)} On request

Technical data – Increased safety motors

EEx e II T3, Aluminium frame, sizes 112 to 250

IP 55, IC 411; Insulation class F, temperature rise class B

Output kW	Type designation	Product code	Speed r/min	Effi- ciency	Power	Current		Torque			Time tE sec	Moment of inertia		Weight kg	Sound pressure level LP dB(A)
				FL 100%	factor cos φ	I _N A	I _s A	T _N Nm	T _s Nm	T _{max} Nm		J=1/4 GD ² kgm ²	GD ² kg		
1000 r/min = 6 poles															
400 V 50 Hz															
2.2	¹⁾ M2AA 112 M	3GAA 113 001-••A	940	80.5	0.76	5.3	5.7	22	2.1	2.7	15	0.015	27	54	
3	M2AA 132 S	3GAA 133 001-••A	960	84.5	0.76	6.9	7.0	30	2.4	2.6	14	0.031	39	61	
4	¹⁾ M2AA 132 MA	3GAA 133 002-••A	960	85.5	0.79	8.9	6.7	40	2.6	2.8	11	0.038	46	61	
5.5	¹⁾ M2AA 132 MB	3GAA 133 003-••A	960	86.0	0.81	11.5	7.1	55	2.8	2.8	9.5	0.045	54	61	
7.5	M2AA 160 M	3GAA 163 101-••A	970	89.3	0.79	15.4	6.6	74	2.0	2.8	17	0.089	88	59	
11	¹⁾ M2AA 160 L	3GAA 163 102-••A	970	89.8	0.78	23	7.3	108	2.2	2.9	11.5	0.107	102	59	
14	¹⁾ M2AA 160 LB	3GAA 163 103-••A	980	89.1	0.74	30	8.4	136	2.7	3.1	7	0.127	117	62	
15	M2AA 180 L	3GAA 183 101-••A	970	90.8	0.78	31	7.1	148	2.1	3.0	17	0.217	151	59	
18.5	¹⁾ M2AA 180 LB	3GAA 183 102-••A	965	90.6	0.79	37.5	6.3	183	2.0	2.6	8.5	0.237	160	59	
18.5	M2AA 200 MLA	3GAA 203 001-••A	980	91.9	0.83	35	6.9	180	2.5	2.7	15	0.37	165	63	
22	M2AA 200 MLB	3GAA 203 002-••A	980	91.1	0.83	42	7.3	214	2.5	2.7	13.5	0.43	185	63	
30	M2AA 225 SMB	3GAA 223 001-••A	985	92.2	0.81	58	7.4	291	2.5	2.7	6.5	0.64	225	63	
37	M2AA 250 SMA	3GAA 253 001-••A	990	93.0	0.82	70	6.9	357	2.8	2.8	9	1.16	280	63	
45	M2AA 250 SMB	3GAA 253 002-••A	985	93.2	0.84	83	7.0	436	2.8	2.8	8.5	1.49	320	63	
750 r/min = 8 poles															
400 V 50 Hz															
4	M2AA 160 MA	3GAA 164 101-••A	715	84.1	0.69	10	5.0	53	2.1	2.4	20	0.072	75	59	
5.5	¹⁾ M2AA 160 M	3GAA 164 102-••A	710	84.7	0.70	13.4	5.1	74	2.4	2.6	19	0.091	88	59	
7.5	¹⁾ M2AA 160 L	3GAA 164 103-••A	715	86.3	0.70	18.1	5.2	100	2.4	2.8	20	0.131	118	59	
8.5	¹⁾ M2AA 160 LB	3GAA 164 104-••A	700	83.5	0.70	21	5.2	116	2.4	2.5	16	0.131	118	45	
11	M2AA 180 L	3GAA 184 101-••A	720	88.7	0.76	23.5	5.3	146	2.4	2.6	30	0.224	147	59	
13	M2AA 180 LB	3GAA 184 102-••A	725	88.0	0.74	28	6.1	171	2.9	3.0	14	0.24	155	62	
15	M2AA 200 MLA	3GAA 204 001-••A	735	90.2	0.80	30	7.2	195	1.8	3.0	17	0.45	175	60	
18.5	M2AA 225 SMA	3GAA 224 001-••A	735	89.0	0.75	40	6.5	240	1.6	2.5	17	0.61	210	63	
22	M2AA 225 SMB	3GAA 224 002-••A	735	90.1	0.75	47	6.1	286	1.9	2.7	19	0.68	225	63	
30	¹⁾ M2AA 250 SMA	3GAA 254 001-••A	740	92.2	0.77	61	7.1	387	1.9	2.9	15	1.25	280	63	
37	M2AA 250 SMB	3GAA 254 002-••A	735	91.4	0.80	73	7.4	481	2.0	2.9	15	1.52	320	63	

¹⁾ Temperature rise class F.

Note: M2AA stocked motors cannot be restamped for 440 V 60 Hz; available during new production. Stocked motors with voltage code S and D can be restamped for 460 VY and voltage code D for 460 VD; except 2-pole type M2AA 132 SB and 2- and 4-pole M2AA 200-250 motors which need special winding.

When placing orders for frame sizes 90-100, the variant code +273 should be added.

ATEX certification process ongoing for frame sizes 112-250.

The two bullets in the product code indicate choice of mounting arrangement (see ordering information), voltage and frequency (below).

Motor size	S		D		H	E	F	T	U	X
	50 Hz	60 Hz	50 Hz	60 Hz	50 Hz	50 Hz	50 Hz	50 Hz	50 Hz	
90-100	230 VΔ 400 VY	–	400 VΔ 690 VY	–	415 VΔ ^{a)}	500 VΔ	500 VY	660 VΔ ^{a)}	690 VΔ ^{a)}	Other rated voltage, connection or frequency,
112-250	230 VΔ 400 VY	460 VY	400 VΔ 690 VY	460 VΔ	415 VΔ	500 VΔ	–	660 VΔ	690 VΔ	690 V maximum

^{a)} On request

Technical data – Increased safety motors

Ex e II T3, Cast iron frame, sizes 80 to 400



IP 55, IC 411; Insulation class F, temperature rise class B - acc. to EN

Output kW	Type designation	Product code	Speed r/min	Efficiency FL 100%	Power factor cos φ	Current		Torque			Time tE ²⁾ sec	Moment of inertia J=1/4 GD ² kgm ²	Weight kg	Sound pressure level LP dB(A)	
						I _N ²⁾ A	I _s / I _N	T _N Nm	T _s / T _N	T _{max} / T _N					
3000 r/min = 2 poles															
400 V 50 Hz															
0.75 ³⁾⁴⁾	M2BA 80 M2 AR	3GTA 081 310-••A	2820	77.0	0.85	1.8	5.5	2.5	2.3	2.4	25	0.0007	13	1)	
1.1 ³⁾⁴⁾	M2BA 80 M2 BR	3GTA 081 320-••A	2820	80.0	0.84	2.4	6.0	3.7	2.9	3.0	13	0.0009	15	1)	
1.3 ³⁾⁴⁾	M2BA 90 S2 BR	3GTA 091 120-••A	2860	80.0	0.88	2.7	5.8	4.3	2.6	2.8	16	0.0016	19	1)	
1.85 ³⁾⁴⁾	M2BA 90 L2 BR	3GTA 091 520-••A	2880	82.0	0.87	3.8	6.5	6.1	2.7	2.9	11	0.002	21	1)	
2.5 ³⁾⁴⁾	M2BA 100 L2 AR	3GTA 101 510-••A	2870	80.0	0.87	5.3	6.4	8.3	2.1	2.3	8	0.0028	31	1)	
3.3 ³⁾⁴⁾	M2BA 112 M2 AR	3GTA 111 310-••A	2870	82.0	0.91	6.4	6.0	11	1.7	2.0	11	0.0055	43	1)	
4.6 ³⁾⁴⁾	M2BA 132 S2 AR	3GTA 131 110-••A	2900	81.0	0.90	9.5	6.7	15	2.7	2.9	12	0.01	62	1)	
5.5 ³⁾⁴⁾	M2BA 132 S2 BR	3GTA 131 120-••A	2920	81.0	0.91	10.7	7.2	18	2.8	3.1	10	0.013	74	1)	
8	M3HP 160 MLB	3GHP 161 420-••G	2940	89.5	0.91	14.5	7.3	26	2.8	3.5	14	0.047	156	76	
11	M3HP 160 MLC	3GHP 161 430-••G	2943	90.7	0.92	19	7.7	36	2.6	3.4	11	0.054	167	76	
12.5	M3HP 160 MLD	3GHP 161 440-••G	2938	89.9	0.92	22	7.7	41	2.8	3.4	8	0.059	173	76	
15	M3HP 180 MLB	3GHP 181 420-••G	2952	91.8	0.91	26	7.6	49	2.4	3.3	10	0.092	210	77	
18	M3HP 180 MLC	3GHP 181 430-••G	2949	92.1	0.91	31	7.2	58	2.4	3.2	9	0.114	229	77	
22	M3HP 200 MLC	3GHP 201 430-••G	2956	93.0	0.90	38.5	6.9	71	2.6	3.5	10	0.21	305	77	
25	M3HP 200 MLE	3GHP 201 450-••G	2957	93.5	0.89	44	7.0	81	2.9	3.8	9	0.22	310	77	
30	M3HP 225 SMB	3GHP 221 220-••G	2963	92.0	0.91	51	7.4	97	2.1	3.0	10	0.31	365	77	
36	M3HP 225 SMD	3GHP 221 240-••G	2964	93.6	0.91	60	7.9	116	2.3	3.2	5	0.36	395	77	
40	M3HP 250 SMB	3GHP 251 220-••G	2971	93.9	0.91	67	7.7	129	1.9	3.1	8	0.66	475	75	
47	M3HP 250 SMC	3GHP 251 230-••G	2972	94.3	0.90	80	7.8	151	2.3	3.0	6	0.69	495	75	
60	M3HP 280 SMA	3GHP 281 210-••G	2975	94.2	0.91	101	7.2	193	1.2	2.9	8	0.8	625	77	
75	M3HP 280 SMB	3GHP 281 220-••G	2975	94.8	0.91	125	7.4	241	1.2	2.9	6	0.9	665	77	
80	M3HP 280 SMC	3GHP 281 230-••G	2975	95.0	0.92	132	7.6	257	1.2	2.8	6	1.15	725	77	
77	M3HP 315 SMA	3GBP 311 210-••G	2981	95.0	0.91	130	7.0	247	0.9	2.9	7	1.2	880	78	
90	M3HP 315 SMB	3GHP 311 220-••G	2981	95.2	0.92	150	6.9	288	0.9	2.8	7	1.4	940	78	
120	M3HP 315 SMC	3GHP 311 230-••G	2981	95.8	0.92	197	7.0	384	1.0	2.9	6	1.7	1025	78	
135	M3HP 315 MLA	3GHP 311 410-••G	2982	95.9	0.92	222	7.8	432	1.2	3.0	6	2.1	1190	78	
165 ³⁾	M2BA 355 S	3GBA 351 100-••A	2978	95.4	0.93	270	6.3	529	0.9	2.5	7	3.8	1550	83	
190 ³⁾	M2BA 355 SMA	3GBA 351 210-••A	2978	95.6	0.93	310	6.5	609	0.9	2.6	6	4.8	1750	83	
215 ³⁾	M2BA 355 MLA	3GBA 351 410-••A	2980	95.8	0.94	345	6.9	689	0.9	2.5	9	6	2150	83	
215 ³⁾	M2BA 400 M	3GBA 401 300-••A	2980	95.8	0.94	345	6.9	689	0.9	2.5	9	6	2200	83	
300 ³⁾	M2BA 400 LKA	3GBA 401 510-••A	2980	96.2	0.93	480	7.0	961	0.8	3.2	5	7.5	2850	85	

- 1) On request.
- 2) Value may differ by different voltage codes.
- 3) ATEX certification process ongoing.
- 4) Temperature rise class F.

Notes:

- When ordering sizes 160-200 with lifetime lubrication, variant code 194 'ZZ-bearings at both ends' has to be added

Data for other voltages and frequencies, on request.

The two bullets in the product code indicate choice of mounting arrangement (see ordering information), voltage and frequency (below).

S ^{a) b)}	D ^{a) b)}	A ^{a)}	B ^{a)}	E	F	G	H	T	U	X
400VY 50Hz	400VΔ50Hz	380VY 50Hz	380VΔ50Hz	500VΔ50 Hz	500VY 50Hz	415VY 50Hz	415VΔ50Hz	660VΔ50Hz	690VΔ50Hz	Other rated volt. conn. or freq. max. 690 V
230VD 50Hz	690VY 50Hz	220VD 50Hz	660VY 60Hz							

^{a)} Motor sizes 80-250: For wide range voltage acc. to IEC 38 please apply variant code 002: Restamping of voltage. Data for wide range voltage can be taken from page 61-62.

^{b)} Motor sizes 80-250: For fixed voltages 230 V Δ and 400 V Δ please apply variant code 002: Restamping of voltage.

Technical data – Increased safety motors

EEx e II T3, Cast iron frame, sizes 80 to 400



IP 55, IC 411; Insulation class F, temperature rise class B - acc. to EN

Output kW	Type designation	Product code	Speed r/min	Effi- ciency FL 100%	Power factor cos φ	Current		Torque			Time tE ²⁾ sec	Moment of inertia J=1/4 GD ²		Sound pressure level LP dB(A)	
						I _N ²⁾ A	I _s A	T _N Nm	T _s Nm	T _{max} Nm		kgm ²	kg		
1500 r/min = 4 poles															
400 V 50 Hz															
0.55 ³⁾⁴⁾	M2BA 80 M4 AR	3GTA 082 310-••A	1400	71.0	0.75	1.5	4.0	3.7	2.0	2.1	32	0.0011	13	1)	
0.75 ³⁾⁴⁾	M2BA 80 M4 BR	3GTA 082 320-••A	1405	75.0	0.74	2	4.3	5.1	2.3	2.4	18	0.0015	15	1)	
1 ³⁾⁴⁾	M2BA 90 S4 BR	3GTA 092 120-••A	1420	78.0	0.78	2.4	5.0	6.7	2.2	2.4	17	0.0025	18	1)	
1.35 ³⁾⁴⁾	M2BA 90 L4 BR	3GTA 092 520-••A	1420	80.0	0.75	3.2	5.7	9.1	2.3	2.7	18	0.0033	21	1)	
2 ³⁾⁴⁾	M2BA 100 L4 AR	3GTA 102 510-••A	1430	79.0	0.78	4.8	5.6	13.3	2.2	2.4	12	0.0045	27	1)	
2.5 ³⁾⁴⁾	M2BA 100 L4 BR	3GTA 102 520-••A	1435	81.0	0.77	6	6.0	16.6	2.5	2.7	11	0.006	30	1)	
3.6 ³⁾⁴⁾	M2BA 112 M4 AR	3GTA 112 310-••A	1440	84.0	0.83	7.7	7.0	24	2.8	3.0	12	0.012	43	1)	
5 ³⁾⁴⁾	M2BA 132 S4 AR	3GTA 132 110-••A	1440	86.0	0.84	10	6.2	33	2.6	2.8	10	0.023	62	1)	
6.8 ³⁾⁴⁾	M2BA 132 M4 AR	3GTA 132 310-••A	1440	87.0	0.88	13.2	6.2	45	2.3	2.5	10	0.032	74	1)	
11	M3HP 160 MLC	3GHP 162 430-••G	1463	90.7	0.84	21	7.2	72	2.6	3.1	15	0.09	166	62	
15	M3HP 160 MLE	3GHP 162 450-••G	1468	91.6	0.83	29	8.1	98	3.1	3.6	6	0.121	189	68	
17	M3HP 180 MLB	3GHP 182 420-••G	1471	92.4	0.84	33	6.6	110	2.3	2.9	12	0.191	214	66	
20	M3HP 180 MLC	3GHP 182 430-••G	1476	92.9	0.82	38	7.4	129	2.7	3.1	8	0.239	233	66	
26	M3HP 200 MLA	3GHP 202 410-••G	1479	92.5	0.87	47	7.9	168	1.9	3.1	13	0.3	280	73	
30	M3HP 200 MLB	3GHP 202 420-••G	1477	92.8	0.88	54	7.4	194	1.9	3.0	9	0.35	305	73	
38	M3HP 225 SMB	3GHP 222 220-••G	1479	93.5	0.88	67	7.3	245	1.7	3.1	9	0.45	365	74	
43	M3HP 225 SMC	3GHP 222 230-••G	1479	93.6	0.89	76	7.7	277	1.8	3.1	5	0.53	390	74	
50	M3HP 250 SMA	3GHP 252 210-••G	1482	93.6	0.87	88	7.1	322	1.5	3.1	8	0.77	425	73	
60	M3HP 250 SMB	3GHP 252 220-••G	1483	94.8	0.88	105	7.3	386	1.7	3.2	8	0.98	470	73	
65	M3HP 280 SMA	3GHP 282 210-••G	1485	94.9	0.88	113	7.4	418	1.5	3.0	7	1.25	625	68	
75	M3HP 280 SMB	3GHP 282 220-••G	1484	95.1	0.90	128	7.5	483	1.5	3.0	7	1.5	665	68	
82	M3HP 280 SMC	3GHP 282 230-••G	1483	95.3	0.91	136	7.4	528	1.5	2.8	7	1.85	725	68	
95	M3HP 315 SMA	3GHP 312 210-••G	1488	95.5	0.91	160	7.0	610	1.1	2.5	7	2.3	900	73	
110	M3HP 315 SMB	3GHP 312 220-••G	1487	95.6	0.90	185	7.0	706	1.1	2.6	6	2.6	960	73	
128	M3HP 315 SMC	3GHP 312 230-••G	1487	95.8	0.90	215	7.0	822	1.1	2.6	6	2.9	1000	73	
145	M3HP 315 MLA	3GHP 312 410-••G	1488	96.1	0.91	242	7.2	931	1.1	2.6	6	3.5	1160	73	
180 ³⁾	M2BA 355 S	3GBA 352 100-••A	1490	96.0	0.88	310	6.3	1153	1.2	2.7	8	6.5	1550	80	
220 ³⁾	M2BA 355 SMA	3GBA 352 210-••A	1490	96.3	0.89	375	6.4	1410	1.2	2.7	7	8.2	1800	80	
275 ³⁾	M2BA 355 MLA	3GBA 352 410-••A	1488	96.5	0.89	465	6.4	1764	1.3	2.6	6	10	2100	80	
275 ³⁾	M2BA 400 M	3GBA 402 300-••A	1488	96.5	0.89	465	6.4	1764	1.3	2.6	6	10	2150	80	
330 ³⁾	M2BA 400 LKA	3GBA 402 510-••A	1490	96.6	0.91	545	6.6	2115	1.0	2.7	6	12	2900	85	

1) On request

2) Value may differ by different voltage codes.

3) ATEX certification process ongoing.

4) Temperature rise class F.

Notes:

- When ordering sizes 160-200 with lifetime lubrication, variant code 194 'ZZ-bearings at both ends' has to be added

Data for other voltages and frequencies, on request.

The two bullets in the product code indicate choice of mounting arrangement (see ordering information), voltage and frequency (below).

S ^{a) b)}	D ^{a) b)}	A ^{a)}	B ^{a)}	E	F	G	H	T	U	X
400VY 50Hz	400VΔ50Hz	380VY 50Hz	380VΔ50Hz	500VΔ50 Hz	500VY 50Hz	415VY 50Hz	415VΔ50Hz	660VΔ50Hz	690VΔ50Hz	Other rated volt. conn. or freq. max. 690 V
230VD 50Hz	690VY 50Hz	220VD 50Hz	660VY 60Hz							

^{a)} Motor sizes 80-250: For wide range voltage acc. to IEC 38 please apply variant code 002: Restamping of voltage. Data for wide range voltage can be taken from page 61-62.

^{b)} Motor sizes 80-250: For fixed voltages 230 VΔ and 400 VΔ please apply variant code 002: Restamping of voltage.

Technical data – Increased safety motors

EEx e II T3, Cast iron frame, sizes 80 to 400



IP 55, IC 411; Insulation class F, temperature rise class B - acc. to EN

Output kW	Type designation	Product code	Speed r/min	Efficiency FL 100%	Power factor cos φ	Current		Torque			Time tE ²⁾ sec	Moment of inertia J=1/4 GD ² kgm ²	Weight kg	Sound pressure level LP dB(A)	
						I _N ²⁾ A	I _s A	T _N Nm	T _s T _N	T _{max} T _N					
1000 r/min = 6 poles															
400 V 50 Hz															
0.37 ³⁾⁴⁾	M2BA 80 M6 AR	3GTA 083 310-••A	975	73.0	0.68	1.1	3.9	3.8	2.3	2.2	63	0.0023	10	1)	
0.55 ³⁾⁴⁾	M2BA 80 M6 BR	3GTA 083 320-••A	975	72.0	0.71	1.6	3.8	6.8	2.2	2.1	46	0.0029	11	1)	
0.7 ³⁾⁴⁾	M2BA 90 S6 BR	3GTA 093 120-••A	930	74.0	0.72	1.9	3.9	7.1	2.0	2.0	38	0.004	16	1)	
0.95 ³⁾⁴⁾	M2BA 90 L6 BR	3GTA 093 520-••A	930	76.0	0.69	2.7	4.3	8.7	2.4	2.2	26	0.0065	18	1)	
1.3 ³⁾⁴⁾	M2BA 100 L6 BR	3GTA 103 520-••A	955	79.0	0.72	3.2	5.5	13	2.5	2.3	25	0.01	22	1)	
1.9 ³⁾⁴⁾	M2BA 112 M6 AR	3GTA 113 310-••A	955	84.0	0.76	4.3	6.2	16.8	2.4	2.4	24	0.01	34	1)	
2.6 ³⁾⁴⁾	M2BA 132 S6 AR	3GTA 133 110-••A	965	84.0	0.77	5.7	6.8	25.7	2.4	2.7	20	0.032	48	1)	
3.5 ³⁾⁴⁾	M2BA 132 M6 AR	3GTA 133 310-••A	965	86.0	0.81	7.4	6.1	34.8	2.2	2.6	18	0.038	56	1)	
6.6	M3HP 160 MLA	3GHP 163 410-••G	972	88.9	0.77	13.8	7.3	65	2.1	3.4	17	0.088	160	57	
7.5	M3HP 160 MLB	3GHP 163 420-••G	974	89.8	0.77	15.5	7.7	74	2.1	3.6	20	0.106	173	65	
11	M3HP 160 MLC	3GHP 163 430-••G	971	89.9	0.75	23.7	7.0	108	2.6	3.8	10	0.127	188	65	
14	M3HP 180 MLB	3GHP 183 420-••G	975	91.1	0.78	28.5	7.6	137	1.8	3.0	16	0.221	233	67	
16.5	M3HP 200 MLB	3GHP 203 420-••G	984	91.5	0.83	32	7.4	160	3.2	3.3	17	0.47	290	65	
20	M3HP 200 MLC	3GHP 203 430-••G	983	92.0	0.84	38	7.1	194	3.0	2.7	17	0.52	305	65	
30	M3HP 225 SMC	3GHP 223 230-••G	985	92.8	0.83	56	7.0	291	2.9	3.0	7	0.78	380	64	
37	M3HP 250 SMB	3GHP 253 220-••G	988	94.0	0.86	66	7.2	358	2.6	2.8	8	1.6	465	65	
45	M3HP 280 SMA	3GHP 283 210-••G	988	94.1	0.87	79	7.6	435	1.5	2.8	6	1.85	605	66	
50	M3HP 280 SMB	3GHP 283 220-••G	987	94.2	0.88	86	7.0	484	1.4	2.5	6	2.2	645	66	
62	M3HP 280 SMC	3GHP 283 230-••G	987	94.6	0.88	107	7.3	600	1.5	2.6	6	2.85	725	66	
72	M3HP 315 SMA	3GHP 313 210-••G	992	94.6	0.86	128	7.0	693	1.3	2.5	7	3.2	830	72	
85	M3HP 315 SMB	3GHP 313 220-••G	991	94.9	0.87	148	7.0	819	1.3	2.4	6	4.1	930	72	
100	M3HP 315 SMC	3GHP 313 230-••G	991	95.3	0.86	176	7.2	964	1.5	2.6	6	4.9	1000	72	
120	M3HP 315 MLA	3GHP 313 410-••G	991	95.5	0.86	212	7.2	1156	1.5	2.5	5	5.8	1150	72	
145 ³⁾	M2BA 355 S	3GBA 353 100-••A	993	95.5	0.85	260	6.4	1394	1.3	2.5	6	10.4	1550	75	
175 ³⁾	M2BA 355 SMA	3GBA 353 210-••A	993	95.8	0.84	315	6.8	1683	1.4	2.6	6	12.5	1800	75	
225 ³⁾	M2BA 355 MLA	3GBA 353 410-••A	993	96.1	0.85	400	6.7	2163	1.4	2.6	6	14.6	2100	75	
225 ³⁾	M2BA 400 MA	3GBA 403 310-••A	993	96.1	0.85	400	6.7	2163	1.4	2.6	6	14.6	2150	75	
290 ³⁾	M2BA 400 LKA	3GBA 403 510-••A	992	96.3	0.86	510	5.8	2792	1.2	2.6	6	16.5	2800	80	
350 ³⁾	M2BA 400 LKB	3GBA 403 520-••A	993	96.4	0.87	600	6.1	3366	1.2	2.6	6	19	3050	80	

- 1) On request
- 2) Value may differ by different voltage codes.
- 3) ATEX certification process ongoing.
- 4) Temperature rise class F.

Notes:

- When ordering sizes 160-200 with lifetime lubrication, variant code 194 'ZZ-bearings at both ends' has to be added

Data for other voltages and frequencies, on request.

Technical data – Increased safety motors

Ex e II T3, Cast iron frame, sizes 80 to 400



IP 55, IC 411; Insulation class F, temperature rise class B - acc. to EN

Output kW	Type designation	Product code	Speed r/min	Efficiency FL 100%	Power factor cos φ	Current		Torque			Time tE ²⁾ sec	Moment of inertia		Sound pressure level LP dB(A)	
						I _N ²⁾ A	I _s A	T _N Nm	T _s Nm	T _{max} Nm		J=1/4 GD ² kgm ²	Weight kg		
750 r/min = 8 poles															
400 V 50 Hz															
0.25 ³⁾⁴⁾	M2BA 80 M8 AR	3GTA 084 310-••A	625	62.0	0.64	0.91	2.7	3.5	2.0	2.2	90	0.002	9.5	44	
0.37 ³⁾⁴⁾	M2BA 80 M8 BR	3GTA 084 320-••A	690	62.0	0.57	1.5	3.1	5.1	2.7	2.9	90	0.0026	11	44	
0.55 ³⁾⁴⁾	M2BA 90 L8 AR	3GTA 094 510-••A	680	63.0	0.68	1.7	3.1	7.7	1.8	2.0	90	0.0055	17	47	
0.65 ³⁾⁴⁾	M2BA 100 L8 AR	3GTA 104 510-••A	705	70.0	0.64	2.1	3.6	8.8	2.0	2.2	35	0.008	22	54	
0.95 ³⁾⁴⁾	M2BA 100 L8 BR	3GTA 104 520-••A	705	73.0	0.65	2.9	3.8	12.7	2.0	2.2	26	0.0105	26	54	
1.3 ³⁾⁴⁾	M2BA 112 M8 AR	3GTA 114 310-••A	715	79.0	0.64	3.7	4.7	17.4	2.5	2.8	34	0.018	45	54	
1.9 ³⁾⁴⁾	M2BA 132 S8 AR	3GTA 134 110-••A	705	80.0	0.78	4.4	4.3	25.7	1.8	2.0	35	0.03	64	54	
2.6 ³⁾⁴⁾	M2BA 132 M8 AR	3GTA 134 310-••A	710	83.0	0.78	6.1	4.8	35	2.2	2.4	32	0.04	77	52	
3.5	M3HP 160 MLA	3GHP 164 410-••G	719	82.3	0.65	9.5	5.1	46	1.8	2.9	21	0.071	146	59	
4.8	M3HP 160 MLB	3GHP 164 420-••G	719	84.9	0.69	12	5.5	64	1.8	2.9	20	0.09	160	53	
6.6	M3HP 160 MLC	3GHP 164 430-••G	716	85.7	0.70	16.2	5.6	88	1.8	3.0	16	0.121	188	55	
9.7	M3HP 180 MLB	3GHP 184 420-••G	727	90.1	0.74	21	5.9	127	1.7	2.8	17	0.239	227	63	
15	M3HP 200 MLB	3GHP 204 420-••G	736	90.8	0.79	30.5	7.0	195	2.2	3.4	20	0.54	300	64	
22	M3HP 225 SMC	3GHP 224 230-••G	734	91.5	0.80	43.5	6.9	286	2.1	3.3	22	0.75	375	65	
27	M3HP 250 SMA	3GHP 254 210-••G	736	91.9	0.82	51	6.6	350	1.9	2.8	21	1.25	420	65	
32	M3HP 250 SMB	3GHP 254 220-••G	737	92.4	0.82	61	7.0	415	2.0	2.9	13	1.52	465	65	
37	M3HP 280 SMA	3GHP 284 210-••G	741	93.0	0.80	72	6.7	477	1.5	2.6	10	1.85	605	65	
45	M3HP 280 SMB	3GHP 284 220-••G	741	93.4	0.79	88	7.3	580	1.7	2.9	7	2.2	645	65	
55	M3HP 280 SMC	3GHP 284 230-••G	741	94.0	0.80	105	7.8	709	1.8	3.0	5	2.85	725	65	
55	M3HP 315 SMA	3GHP 314 210-••G	743	94.3	0.80	105	6.2	707	1.2	2.2	12	3.2	830	62	
75	M3HP 315 SMB	3GHP 314 220-••G	743	94.8	0.80	142	6.5	964	1.3	2.2	7	4.1	930	62	
90	M3HP 315 SMC	3GHP 314 230-••G	743	95.0	0.81	173	6.4	1157	1.4	2.2	7	4.9	1000	64	
105	M3HP 315 MLA	3GHP 314 410-••G	742	95.3	0.81	197	6.5	1351	1.4	2.2	5	5.8	1150	72	
120 ³⁾	M2BA 355 S	3GBA 354 100-••A	743	95.0	0.79	230	6.2	1542	1.4	2.2	10	10.4	1550	75	
145 ³⁾	M2BA 355 SMA	3GBA 354 210-••A	743	95.4	0.80	275	6.5	1863	1.5	2.2	6	12.5	1800	75	
180 ³⁾	M2BA 355 MLA	3GBA 354 410-••A	744	95.7	0.77	350	6.5	2310	1.4	2.4	6	14.6	2150	75	
180 ³⁾	M2BA 400 M	3GBA 404 300-••A	744	95.7	0.77	350	6.5	2310	1.4	2.4	6	14.6	2150	75	
230 ³⁾	M2BA 400 LKA	3GBA 404 510-••A	745	96.1	0.80	430	6.5	2948	1.4	2.7	6	16.5	2800	80	
280 ³⁾	M2BA 400 LKB	3GBA 404 520-••A	745	96.2	0.81	520	6.1	3589	1.3	2.6	6	19	3050	80	

¹⁾ On request.

²⁾ Value may differ by different voltage codes.

³⁾ ATEX certification process ongoing.

⁴⁾ Temperature rise class F.

Notes:

- When ordering sizes 160-200 with lifetime lubrication, variant code 194 'ZZ-bearings at both ends' has to be added

Data for other voltages and frequencies, on request.

The two bullets in the product code indicate choice of mounting arrangement (see ordering information), voltage and frequency (below).

S ^{a) b)}	D ^{a) b)}	A ^{a)}	B ^{a)}	E	F	G	H	T	U	X
400VY 50Hz	400VΔ50Hz	380VY 50Hz	380VΔ50Hz	500VΔ50 Hz	500VY 50Hz	415VY 50Hz	415VΔ50Hz	660VΔ50Hz	690VΔ50Hz	Other rated volt. conn. or freq. max. 690 V
230VD 50Hz	690VY 50Hz	220VD 50Hz	660VY 60Hz							

^{a)} Motor sizes 80-250: For wide range voltage acc. to IEC 38 please apply variant code 002: Restamping of voltage. Data for wide range voltage can be taken from page 61-62.

^{b)} Motor sizes 80-250: For fixed voltages 230 VΔ and 400 VΔ please apply variant code 002: Restamping of voltage.

Technical data – Increased safety motors

EEx e II T3, Cast iron frame, sizes 80 to 400



IP 55, IC 411; Insulation class F, temperature rise class B - acc. to VIK

Output kW	Type designation	Product code	Speed r/min	Efficiency	Power factor cos φ	Current		Torque			Time tE ³⁾ sec	Moment of inertia J=1/4 GD ² kgm ²	Weight kg	Sound pressure level LP dB(A)	
				FL 100%		I _N ³⁾ A	I _s A	T _N Nm	T _s T _N	T _{max} T _N					
3000 r/min = 2 poles															
380...420 V 50 Hz															
0.75 ⁴⁾⁵⁾	M2BA 80 M2 AR	3GTA 081 310-••A	2820	77.0	0.85	1.8	5.5	2.5	2.3	2.4	25	0.0007	13	58	
1.1 ⁴⁾⁵⁾	M2BA 80 M2 BR	3GTA 081 320-••A	2820	80.0	0.84	2.4	6.0	3.7	2.9	3.0	13	0.0009	15	58	
1.3 ⁴⁾⁵⁾	M2BA 90 S2 BR	3GTA 091 120-••A	2860	80.0	0.88	2.7	5.8	4.3	2.6	2.8	16	0.0016	19	61	
1.85 ⁴⁾⁵⁾	M2BA 90 L2 BR	3GTA 091 520-••A	2880	82.0	0.87	3.8	6.5	6.1	2.7	2.9	11	0.002	21	61	
2.5 ⁴⁾⁵⁾	M2BA 100 L2 AR	3GTA 101 510-••A	2870	80.0	0.87	5.3	6.4	8.3	2.1	2.3	8	0.0028	31	65	
3.3 ⁴⁾⁵⁾	M2BA 112 M2 AR	3GTA 111 310-••A	2870	82.0	0.91	6.4	6.0	11	1.7	2.0	11	0.0055	43	68	
4.6 ⁴⁾⁵⁾	M2BA 132 S2 AR	3GTA 131 110-••A	2900	81.0	0.90	9.5	6.7	15	2.7	2.9	12	0.01	62	73	
5.5 ⁴⁾⁵⁾	M2BA 132 S2 BR	3GTA 131 120-••A	2920	81.0	0.91	10.7	7.2	18	2.8	3.1	10	0.013	74	73	
7.5	M3HP 160 MLB	3GHP 161 420-••G	2946	89.4	0.91	14.3	7.4	24	3.0	3.7	16	0.047	156	76	
10	M3HP 160 MLC	3GHP 161 430-••G	2949	90.7	0.92	18.5	7.9	32	2.9	3.7	12	0.054	167	76	
12.5	M3HP 160 MLD	3GHP 161 440-••G	2938	89.9	0.92	23	7.3	41	2.8	3.4	8	0.059	173	76	
15	M3HP 180 MLB	3GHP 181 420-••G	2952	91.8	0.91	27.5	7.1	49	2.4	3.3	12	0.092	210	77	
20	M3HP 200 MLC	3GHP 202 430-••G	2961	93.2	0.90	37	7.2	65	2.9	3.9	9	0.21	305	77	
24	M3HP 200 MLE	3GHP 202 450-••G	2959	93.5	0.89	44.5	6.9	77	3.0	3.9	9	0.22	310	77	
28	M3HP 225 SMC	3GHP 221 230-••G	2963	93.1	0.91	51	7.0	90	2.1	3.1	14	0.34	385	77	
36	M3HP 250 SMB	3GHP 251 220-••G	2969	93.5	0.90	65	6.7	116	1.9	2.7	9	0.66	475	75	
3000 r/min = 2 poles															
400 V 50 Hz¹⁾															
47	M3HP 280 SMA	3GHP 281 210-••G	2982	94.1	0.91	79	7.1	151	1.2	3.0	12	0.8	625	77 (74) ²⁾	
58	M3HP 280 SMB	3GHP 281 220-••G	2975	94.1	0.91	99	7.0	186	1.2	2.8	10	0.9	665	77 (74) ²⁾	
68	M3HP 315 SMA	3GHP 311 210-••G	2984	94.8	0.90	117	7.7	218	1.0	3.2	10	1.2	880	78 (74) ²⁾	
80	M3HP 315 SMB	3GHP 311 220-••G	2983	95.2	0.91	135	7.6	256	1.1	3.2	10	1.4	940	78 (74) ²⁾	
110	M3HP 315 SMC	3GHP 311 230-••G	2983	95.8	0.92	182	7.7	352	1.1	3.2	8	1.7	1025	78 (74) ²⁾	
125	M3HP 315 MLA	3GHP 311 410-••G	2983	96.1	0.93	204	7.7	400	1.2	3.1	8	2.1	1190	78 (74) ²⁾	
150 ⁴⁾	M2BA 355 S	3GBA 351 100-••A	2981	95.2	0.93	245	6.8	480	1.0	2.7	10	3.8	1550	83 (76) ²⁾	
175 ⁴⁾	M2BA 355 SMA	3GBA 351 210-••A	2981	95.5	0.93	285	7.0	560	1.0	2.8	8	4.8	1750	83 (76) ²⁾	
200 ⁴⁾	M2BA 355 MLA	3GBA 351 410-••A	2982	95.7	0.93	325	7.4	640	1.0	2.7	10	6	2150	83 (76) ²⁾	
200 ⁴⁾	M2BA 400 M	3GBA 401 300-••A	2982	95.7	0.93	325	7.4	640	1.0	2.7	10	6	2200	83 (76) ²⁾	
250 ⁴⁾	M2BA 400 LKA	3GBA 401 510-••A	2983	96.0	0.92	410	7.0	800	0.7	3.2	10	7.5	2850	85 (76) ²⁾	

- 1) Voltage tolerance ± 5%; voltage range 380...420 V on request.
- 2) To reach the lower sound pressure level values an axial fan is used. Please note that the axial fan is a unidirectional fan, direction of rotation to be specified by ordering.
- 3) Sizes 80-250: The max. current is indicated at the nominal voltage range 380-420 V.
- 4) ATEX certification process ongoing.
- 5) Temperature rise class F.

Technical data for corresponding EEx e T2 VIK available on request.

Notes:

- Variant code 421 'VIK design' has to be added when ordering
- When ordering sizes 160-200 with lifetime lubrication, variant code 194 'ZZ-bearings at both ends' has to be added

Data for other voltages and frequencies, on request.

The two bullets in the product code indicate choice of mounting arrangement (see ordering information), voltage and frequency (below).

Motor	S ^{a) b)}	D ^{a) b)}	A ^{a)}	B ^{a)}	E	F	G	H	T	U	X
80-250	218..242VΔ 380..420VY	380..420VΔ 655..725VY	380VY50Hz 220VΔ50Hz	380VΔ50Hz 660VY60Hz	500VΔ50 Hz	500VY50Hz	415VY50Hz	415VΔ50Hz	660VΔ50Hz	690VΔ50Hz	Other voltage, coupl. or freq.
280-400	400VY50Hz 230VΔ50Hz	400VΔ50Hz 690VY50Hz	380VY50Hz 220VΔ50Hz	380VΔ50Hz 660VY60Hz	500VΔ50 Hz	500VY50Hz	415VY50Hz	415VΔ50Hz	660VΔ50Hz	690VΔ50Hz	max. 690 V

^{a)} Motor sizes 80-132: Only one voltage will be stamped on rating plate.
^{b)} Motor sizes 80-132: For fixed voltages 230 VΔ and 400 VΔ please apply variant code 002: Restamping of voltage.

Technical data – Increased safety motors

EEx e II T3, Cast iron frame, sizes 80 to 400



IP 55, IC 411; Insulation class F, temperature rise class B - acc. to VIK

Output kW	Type designation	Product code	Speed r/min	Efficiency FL 100%	Power factor cos φ	Current		Torque			Time tE ²⁾ sec	Moment of inertia		Sound pressure level LP dB(A)	
						I _N ²⁾ A	I _s A	T _N Nm	T _s T _N	T _{max} T _N		J=1/4 GD ² kgm ²	Weight kg		
1500 r/min = 4 poles															
380...420 V 50 Hz															
0.55 ³⁾⁴⁾	M2BA 80 M4 AR	3GTA 082 310-••A	1400	71.0	0.75	1.5	4.0	3.7	2.0	2.1	32	0.0011	13	46	
0.75 ³⁾⁴⁾	M2BA 80 M4 BR	3GTA 082 320-••A	1405	75.0	0.74	2	4.3	5.1	2.3	2.4	20	0.0015	15	46	
1 ³⁾⁴⁾	M2BA 90 S4 BR	3GTA 092 120-••A	1420	78.0	0.78	2.4	5.0	6.7	2.2	2.4	17	0.0025	18	52	
1.35 ³⁾⁴⁾	M2BA 90 L4 BR	3GTA 092 520-••A	1420	80.0	0.75	3.2	5.7	9.1	2.3	2.7	18	0.0033	21	52	
2 ³⁾⁴⁾	M2BA 100 L4 AR	3GTA 102 510-••A	1430	79.0	0.78	4.8	5.6	13.3	2.2	2.4	12	0.0045	27	53	
2.5 ³⁾⁴⁾	M2BA 100 L4 BR	3GTA 102 520-••A	1435	81.0	0.77	6	6.0	16.6	2.5	2.7	11	0.006	30	53	
3.6 ³⁾⁴⁾	M2BA 112 M4 AR	3GTA 112 310-••A	1440	84.0	0.83	7.7	7.0	24	2.8	3.0	12	0.012	43	56	
5 ³⁾⁴⁾	M2BA 132 S4 AR	3GTA 132 110-••A	1440	86.0	0.84	10	6.2	33	2.6	2.8	10	0.023	62	60	
6.8 ³⁾⁴⁾	M2BA 132 M4 AR	3GTA 132 310-••A	1440	87.0	0.88	13.2	6.0	45	2.3	2.5	10	0.032	74	60	
10	M3HP 160 MLC	3GHP 162 430-••G	1468	90.9	0.83	20	7.5	65	2.8	3.4	16	0.09	166	62	
13.5	M3HP 160 MLE	3GHP 162 450-••G	1469	91.5	0.83	26.5	7.7	88	3.0	3.6	8	0.121	189	68	
15	M3HP 180 MLB	3GHP 182 420-••G	1476	92.6	0.82	30	7.1	97	2.6	3.3	16	0.191	214	66	
17.5	M3HP 180 MLC	3GHP 182 430-••G	1477	92.3	0.83	35	7.0	113	2.7	3.2	10	0.239	233	66	
24	M3HP 200 MLA	3GHP 202 410-••G	1480	92.5	0.87	46	7.8	155	2.0	3.2	14	0.3	280	73	
30	M3HP 225 SMB	3GHP 222 220-••G	1481	93.4	0.88	57	6.9	193	1.8	2.6	17	0.45	365	74	
36	M3HP 225 SMC	3GHP 222 230-••G	1480	93.4	0.89	66	7.3	232	1.7	3.1	8	0.53	390	74	
44	M3HP 250 SMB	3GHP 252 220-••G	1482	94.4	0.88	81	6.6	284	1.3	3.0	15	0.98	470	73	
1500 r/min = 4 poles															
400 V 50 Hz¹⁾															
58	M3HP 280 SMA	3GHP 282 210-••G	1484	94.6	0.88	100	7.3	373	1.3	2.9	9	1.25	625	68	
70	M3HP 280 SMB	3GHP 282 220-••G	1484	94.9	0.89	120	7.4	450	1.4	2.9	8	1.5	665	68	
84	M3HP 315 SMA	3GHP 312 210-••G	1489	95.4	0.89	144	7.2	539	1.2	2.9	12	2.3	900	73	
100	M3HP 315 SMB	3GHP 312 220-••G	1489	95.6	0.90	170	7.5	641	1.2	2.9	9	2.6	960	73	
115	M3HP 315 SMC	3GHP 312 230-••G	1488	95.8	0.90	191	7.2	738	1.1	2.7	8	2.9	1000	73	
135	M3HP 315 MLA	3GHP 312 410-••G	1489	95.8	0.90	227	7.7	866	1.3	2.8	7	3.5	1160	73	
165 ³⁾	M2BA 355 S	3GBA 352 100-••A	1491	96.0	0.89	280	6.9	1057	1.3	3.0	9	6.5	1550	80	
200 ³⁾	M2BA 355 SMA	3GBA 352 210-••A	1491	96.2	0.89	335	7.0	1281	1.3	3.0	9	8.2	1800	80	
250 ³⁾	M2BA 355 MLA	3GBA 352 410-••A	1490	96.5	0.89	420	7.2	1602	1.4	2.9	8	10	2100	80	
250 ³⁾	M2BA 400 M	3GBA 402 300-••A	1490	96.5	0.89	420	7.2	1602	1.4	2.9	8	10	2150	80	
300 ³⁾	M2BA 400 LKA	3GBA 402 510-••A	1492	96.6	0.91	490	7.3	1920	1.1	3.0	8	12	2900	85	

¹⁾ Voltage tolerance ± 5%; voltage range 380...420 V on request.

²⁾ Sizes 80-250: The max. current is indicated at the nominal voltage range 380-420 V.

³⁾ ATEX certification process ongoing.

⁴⁾ Temperature rise class F.

Technical data for corresponding EEx e T2 VIK available on request.

Notes:

- Variant code 421 'VIK design' has to be added when ordering
- When ordering sizes 160-200 with lifetime lubrication, variant code 194 'ZZ-bearings at both ends' has to be added

Data for other voltages and frequencies, on request.

The two bullets in the product code indicate choice of mounting arrangement (see ordering information), voltage and frequency (below).

Motor	S ^{a)b)}	D ^{a)b)}	A ^{a)}	B ^{a)}	E	F	G	H	T	U	X
80-250	218..242VΔ 380..420VY	380..420VΔ 655..725VY	380VY50Hz 220VΔ50Hz	380VΔ50Hz 660VY60Hz	500VΔ50 Hz	500VY50Hz	415VY50Hz	415VΔ50Hz	660VΔ50Hz	690VΔ50Hz	Other voltage, coupl. or freq.
280-400	400VY50Hz 230VΔ50Hz	400VΔ50Hz 690VY50Hz	380VY50Hz 220VΔ50Hz	380VΔ50Hz 660VY60Hz	500VΔ50 Hz	500VY50Hz	415VY50Hz	415VΔ50Hz	660VΔ50Hz	690VΔ50Hz	max. 690 V

^{a)} Motor sizes 80-132: Only one voltage will be stamped on rating plate.

^{b)} Motor sizes 80-132: For fixed voltages 230 V Δ and 400 V Δ please apply variant code 002: Restamping of voltage.

Technical data – Increased safety motors

EEx e II T3, Cast iron frame, sizes 80 to 400



IP 55, IC 411; Insulation class F, temperature rise class B - acc. to VIK

Output kW	Type designation	Product code	Speed r/min	Efficiency FL 100%	Power factor cos φ	Current		Torque			Time tE ²⁾ sec	Moment of inertia J=1/4 GD ² kgm ²	Weight kg	Sound pressure level LP dB(A)	
						I _N ²⁾ A	I _s I _N	T _N Nm	T _s T _N	T _{max} T _N					
1000 r/min = 6 poles															
380...420 V 50 Hz															
0.37 ³⁾⁴⁾	M2BA 80 M6 AR	3GTA 083 310-••A	975	73.0	0.68	1.1	3.9	3.8	2.3	2.2	63	0.0023	10	48	
0.55 ³⁾⁴⁾	M2BA 80 M6 BR	3GTA 083 320-••A	975	72.0	0.71	1.6	3.8	6.8	2.2	2.1	46	0.0029	11	48	
0.7 ³⁾⁴⁾	M2BA 90 S6 BR	3GTA 093 120-••A	930	74.0	0.72	1.9	3.9	7.1	2.0	2.0	38	0.004	16	48	
0.95 ³⁾⁴⁾	M2BA 90 L6 BR	3GBA 093 520-••A	930	76.0	0.69	2.7	4.3	8.7	2.4	2.2	26	0.0065	18	48	
1.3 ³⁾⁴⁾	M2BA 100 L6 BR	3GBA 103 520-••A	955	79.0	0.72	3.2	5.5	13	2.5	2.3	25	0.01	22	51	
1.9 ³⁾⁴⁾	M2BA 112 M6 AR	3GBA 113 310-••A	955	84.0	0.76	4.3	6.2	16.8	2.4	2.4	24	0.01	34	54	
2.6 ³⁾⁴⁾	M2BA 132 S6 AR	3GBA 133 110-••A	965	84.0	0.77	5.7	6.8	25.7	2.4	2.7	20	0.032	48	59	
3.5 ³⁾⁴⁾	M2BA 132 M6 AR	3GBA 133 310-••A	960	86.0	0.81	7.4	6.1	34.8	2.2	2.6	18	0.038	56	59	
6.6	M3HP 160 MLA	3GHP 163 410-••G	972	88.9	0.77	14.2	7.1	65	2.1	3.4	15	0.088	160	57	
9.7	M3HP 160 MLC	3GHP 163 430-••G	971	89.8	0.77	21.2	7.1	95	2.4	3.7	11	0.127	173	65	
13.2	M3HP 180 MLB	3GHP 183 420-••G	975	91.0	0.79	27.5	7.2	129	1.7	3.0	15	0.221	233	67	
16.5	M3HP 200 MLB	3GHP 203 420-••G	984	91.5	0.83	33	7.1	160	3.2	3.3	15	0.47	290	65	
20	M3HP 200 MLC	3GHP 203 430-••G	983	92.0	0.84	39	6.9	194	3.0	2.7	16	0.52	305	65	
27	M3HP 225 SMC	3GHP 223 230-••G	987	92.9	0.82	53	7.5	261	3.2	3.4	11	0.78	380	64	
33	M3HP 250 SMB	3GHP 253 220-••G	989	93.6	0.86	63	7.3	319	2.7	2.9	10	1.6	465	65	

1000 r/min = 6 poles															
400 V 50 Hz¹⁾															
40	M3HP 280 SMA	3GHP 283 210-••G	987	94.2	0.89	80	7.5	445	1.4	2.8	18	1.85	605	66	
46	M3HP 280 SMB	3GHP 283 220-••G	993	94.6	0.86	116	7.7	616	1.4	2.8	17	2.85	645	66	
64	M3HP 315 SMA	3GHP 313 210-••G	993	94.9	0.87	133	7.6	731	1.4	2.6	10	3.2	830	72	
76	M3HP 315 SMB	3GHP 313 220-••G	992	95.3	0.85	165	7.7	886	1.6	2.9	8	4.1	930	72	
92	M3HP 315 SMC	3GHP 313 230-••G	992	95.5	0.85	195	7.7	1059	1.7	2.7	8	4.9	1000	72	
110	M3HP 315 MLA	3GHP 313 410-••G	994	95.5	0.84	240	6.9	1268	1.4	2.8	7	5.8	1150	72	
132 ³⁾	M2BA 355 S	3GBA 353 100-••A	994	95.5	0.84	240	6.9	1268	1.4	2.8	9	10.4	1550	75	
160 ³⁾	M2BA 355 SMA	3GBA 353 210-••A	994	95.8	0.84	290	7.4	1537	1.5	2.9	10	12.5	1800	75	
200 ³⁾	M2BA 355 MLA	3GBA 353 410-••A	994	96.0	0.84	360	7.5	1921	1.5	2.9	8	14.6	2100	75	
200 ³⁾	M2BA 400 MA	3GBA 403 310-••A	994	96.0	0.84	360	7.5	1921	1.5	2.9	8	14.6	2150	75	
250 ³⁾	M2BA 400 LKA	3GBA 403 510-••A	994	96.2	0.85	440	7.0	2402	1.3	3.0	8	16.5	2800	80	
300 ³⁾	M2BA 400 LKB	3GBA 403 520-••A	994	96.4	0.86	520	7.0	2882	1.4	3.0	8	19	3050	80	

- ¹⁾ Voltage tolerance ± 5%; voltage range 380...420 V on request.
- ²⁾ Sizes 80-250: The max. current is indicated at the nominal voltage range 380-420 V.
- ³⁾ ATEX certification process ongoing.
- ⁴⁾ Temperature rise class F.

Technical data for corresponding EEx e T2 VIK available on request.

Notes:

- Variant code 421 'VIK design' has to be added when ordering
- When ordering sizes 160-200 with lifetime lubrication, variant code 194 'ZZ-bearings at both ends' has to be added

Data for other voltages and frequencies, on request.

Technical data – Increased safety motors

EEx e II T3, Cast iron frame, sizes 80 to 400

IP 55, IC 411; Insulation class F, temperature rise class B - acc. to VIK

Output kW	Type designation	Product code	Speed r/min	Efficiency FL 100%	Power factor cos φ	Current		Torque			Time tE ²⁾ sec	Moment of inertia J=1/4 GD ² kgm ²	Weight kg	Sound pressure level LP dB(A)	
						I _N ²⁾ A	I _s / I _N	T _N Nm	T _s / T _N	T _{max} / T _N					
750 r/min = 8 poles															
380...420 V 50 Hz															
0.25 ³⁾⁴⁾	M2BA 80 M8 AR	3GTA 084 310-••A	685	62.0	0.64	0.71	2.7	3.5	2.0	2.2	90	0.002	9.5	44	
0.37 ³⁾⁴⁾	M2BA 80 M8 BR	3GTA 084 320-••A	690	62.0	0.57	1.5	3.1	5.1	2.7	2.9	90	0.0026	11	44	
0.55 ³⁾⁴⁾	M2BA 90 L8 AR	3GTA 094 510-••A	680	63.0	0.68	1.7	3.1	7.7	1.8	2.0	90	0.0055	17	47	
0.65 ³⁾⁴⁾	M2BA 100 L8 AR	3GTA 104 510-••A	705	70.0	0.64	2.1	3.6	8.8	2.0	2.2	35	0.008	22	54	
0.95 ³⁾⁴⁾	M2BA 100 L8 BR	3GTA 104 520-••A	705	73.0	0.65	2.9	3.8	12.7	2.0	2.2	26	0.0105	26	54	
1.3 ³⁾⁴⁾	M2BA 112 M8 AR	3GTA 114 310-••A	715	79.0	0.68	3.7	4.7	17.4	2.5	2.8	34	0.018	45	54	
1.9 ³⁾⁴⁾	M2BA 132 S8 AR	3GTA 134 110-••A	705	80.0	0.78	4.4	4.3	25.7	1.8	2.0	35	0.03	64	54	
2.6 ³⁾⁴⁾	M2BA 132 M8 AR	3GTA 134 310-••A	710	83.0	0.78	6.1	4.8	35	2.2	2.4	32	0.04	77	52	
3.5	M3HP 160 MLA	3GHP 164 410-••G	719	82.3	0.65	9.5	5.1	46	1.8	2.9	23	0.071	146	59	
4.8	M3HP 160 MLB	3GHP 164 420-••G	719	84.9	0.69	12.1	5.5	64	1.8	2.9	21	0.09	160	53	
6.6	M3HP 160 MLC	3GHP 164 430-••G	716	85.7	0.70	16.7	5.5	88	1.8	3.0	16	0.121	188	55	
9.7	M3HP 180 MLB	3GHP 184 420-••G	727	90.1	0.74	22	5.7	127	1.7	2.8	14	0.239	227	63	
13.2	M3HP 200 MLB	3GHP 204 420-••G	734	90.4	0.82	27	6.0	172	1.8	3.0	23	0.54	300	64	
16.5	M3HP 225 SMB	3GHP 224 220-••G	736	91.1	0.79	34	6.6	214	2.0	3.0	25	0.68	350	65	
20	M3HP 225 SMC	3GHP 224 230-••G	735	91.4	0.80	41	6.7	260	2.1	3.3	25	0.75	375	65	
27	M3HP 250 SMA	3GHP 254 210-••G	736	91.9	0.82	54	6.3	350	1.9	2.8	16	1.25	420	65	
750 r/min = 8 poles															
400 V 50 Hz¹⁾															
33	M3HP 280 SMA	3GHP 284 210-••G	740	93.2	0.80	64	6.9	426	1.7	2.8	17	1.85	605	65	
40	M3HP 280 SMB	3GHP 284 220-••G	739	93.7	0.81	78	6.8	517	1.6	2.8	18	2.2	645	65	
50	M3HP 315 SMA	3GHP 314 210-••G	744	94.3	0.79	98	6.7	642	1.3	2.4	15	3.2	830	62	
68	M3HP 315 SMB	3GHP 314 220-••G	744	94.9	0.79	132	7.0	873	1.4	2.4	10	4.1	930	62	
80	M3HP 315 SMC	3GHP 314 230-••G	744	95.1	0.80	154	7.2	1027	1.5	2.5	10	4.9	1000	64	
95	M3HP 315 MLA	3GHP 314 410-••G	743	95.3	0.80	182	7.0	1221	1.5	2.4	7	5.8	1150	72	
110 ³⁾	M2BA 355 S	3GBA 354 100-••A	745	95.0	0.79	210	6.7	1410	1.5	2.4	10	10.4	1550	75	
132 ³⁾	M2BA 355 SMA	3GBA 354 210-••A	744	95.4	0.79	255	7.1	1694	1.6	2.4	8	12.5	1800	75	
160 ³⁾	M2BA 355 MLA	3GBA 354 410-••A	745	95.6	0.75	320	7.2	2051	1.6	2.7	8	14.6	2100	75	
160 ³⁾	M2BA 400 M	3GBA 404 300-••A	745	95.6	0.75	320	7.2	2051	1.6	2.7	8	14.6	2150	75	
200 ³⁾	M2BA 400 LKA	3GBA 404 510-••A	746	96.0	0.78	385	7.2	2560	1.6	3.0	8	16.5	2800	80	
250 ³⁾	M2BA 400 LKB	3GBA 404 520-••A	746	96.2	0.79	475	6.7	3200	1.5	2.9	9	19	3050	80	

¹⁾ Voltage tolerance ± 5%; voltage range 380...420 V on request.

²⁾ Sizes 80-250: The max. current is indicated at the nominal voltage range 380-420 V.

³⁾ ATEX certification process ongoing.

⁴⁾ Temperature rise class F.

Technical data for corresponding EEx e T2 VIK available on request.

Notes:

- Variant code 421 'VIK design' has to be added when ordering
- When ordering sizes 160-200 with lifetime lubrication, variant code 194 'ZZ-bearings at both ends' has to be added

Data for other voltages and frequencies, on request.

The two bullets in the product code indicate choice of mounting arrangement (see ordering information), voltage and frequency (below).

Motor	S ^{a) b)}	D ^{a) b)}	A ^{a)}	B ^{a)}	E	F	G	H	T	U	X
80-250	218..242VΔ 380..420VY	380..420VΔ 655..725VY	380VY50Hz 220VΔ50Hz 660VY60Hz	380VΔ50Hz 220VΔ50Hz 660VY60Hz	500VΔ50 Hz	500VY50Hz	415VY50Hz	415VΔ50Hz	660VΔ50Hz	690VΔ50Hz	Other voltage, coupl. or freq.
280-400	400VY50Hz 230VΔ50Hz	400VΔ50Hz 690VY50Hz	380VY50Hz 220VΔ50Hz	380VΔ50Hz 660VY60Hz	500VΔ50 Hz	500VY50Hz	415VY50Hz	415VΔ50Hz	660VΔ50Hz	690VΔ50Hz	max. 690 V

^{a)} Motor sizes 80-132: Only one voltage will be stamped on rating plate.

^{b)} Motor sizes 80-132: For fixed voltages 230 V Δ and 400 V Δ please apply variant code 002: Restamping of voltage.

Rating plates

For motor sizes 80 to 132 the rating plate gives one current value for the voltage area. That is the highest current that can occur within the voltage area with the given output.

For motor sizes 160 to 400 the rating plate is in table form giving values for speed, current and power factor for six voltages.

European standards require a special marking on safety motors. The marking shall include the following:

- type of protection
- apparatus group
- temperature class
- name of certifying body
- certificate number

For increased safety motors, marking shall also include:

- I_A/I_N
- t_E

M3AAL 90-100

ABB Motores, S.A. CE 0163					
Poligono Industrial S.O. Sant Quirze del Valles 08192-Barcelona-Spain					
3~Motor M3AAL 090 L-2		CL. F		IP 55 IEC 34-1	
3GAA 091 002-ASA					
Nº					
	Hz	r/min	kW	A	cos φ
220-230 Δ	50	2870	2,2	8,1	0,86
380-400 Δ	50	2870	2,2	4,7	0,86
EExe II T3		273	I _A /I _N = 6,9 A		
II 2G		LOM 99 ATEX2011		t _E = 8 s	
6305-Z/C3		6204-Z/C3		16 kg	

M2AA 112-132

ABB Motors					
3~Motor M2AA 132 S					
3G AA 132 001-AXA, 97		CL, F		IP 55 IEC 34-1	
No.					
V	Hz	r/min	kW	A	cos φ
400 Δ	50	1450	5,5	10,9	0,83
690 Y	50	1450	5,5	6,3	0,83
EEx e II T3		DEM KO NO.93C.113189			
6208 Z/C3		6206 Z/C3		40 Kg	

M2AA 160-250

ABB Motors					
3~Motor M2AA 200 M LA					
IEC 200 S.M. 55		CL, F		IP 55	
EEx e II T3					
No.					
V	Hz	kW	r/min	A	cos φ
400 Δ	50	26	1470	31	0,84
690 Y	50	26	1470	54	0,84
EEx e II T3		DEM KO NO.93C.113189			
6312 Z/C3		6210 Z/C3		180 kg	
Prod. code 3GAA 202 001-AXA					
IEC 34-1					

M2BA 80-132

ABB Motors			
F.Nr.	Is. K1, F	IP 55	3~M
Type M2BA 80 M4AR			
kw	0,55	Hz	50
V	230 / 400	te	32 s
r/min	1400	A	2,6 / 1,5
cos φ	0,75	EEx e II T3	
I _A /I _N	4,0	ETI Nr. EX 97.D.009	

M3HP 160-315

ABB Oy, Electrical Machines					
LV Motors, Vaasa, Finland					
3~Motor M3HP 180MLB 2 EExe II T3 B3					
IEC 200M/L 48		CL, F		IP 55	
S1					
PH-20341/2001		Ins.cl.		F IP 65	
V	Hz	kW	r/min	A	cos φ
400 D	50	15	2952	26	0,91
690 Y	50	15	2952	15	0,91
Prod. code 3GHP181420-ADG		LCIE 01 ATEX 6021		6310-Z/C3	
6310-Z/C3		6310-Z/C3		210 kg	
II 2G		ABB		IEC 60034-1	

M2BA 355-400

ABB Oy, Electrical Machines					
LV Motors, Vaasa, Finland					
3~Motor M2BA 355SMA 4 EExe IIT3 B3					
IEC 355S/M 100		CL, F		IP 55	
S1					
VH-23762-1		Ins.cl.		F IP 55	
V	Hz	kW	r/min	A	cos φ
660 Y	50	220	1491	225	0,89
380 D	50	220	1491	390	0,89
Prod. code 3GBA352210-ABA273		VTT No. Ex-01.E.012		6322/C3	
6322/C3		6319/C3		1800 kg	
II 2G		ABB		IEC 60034-1	

Variant codes - Increased safety motors

Variant codes / Increased safety motors		Aluminium motors				Cast iron motors			
Code ¹⁾	Variant	90-100	112-132	160-180	200-250	80-132	160-250	280-315	355-400
Balancing									
052	Balancing to grade R (ISO 2373).	P	P	P	P	P	P	P	P
417	Balancing to grade S (ISO 2373).	-	R	R	R	P	P	P	P
424	Full key balancing.	P	P	P	P	P	P	P	P
Bearings and lubrication									
036	Transport lock for bearings.	-	M	M	M	-	-	-	-
037	Roller bearing at D-end.	-	-	R	R	-	P	P	P
039	Cold resistant grease (-55...+100°C).	R	R	R	R	-	M	P	P
040	Heat resistant grease (-25...+150°C). Aluminium motors sizes 63-100: -40...+160°C.	S	S	S	S	-	S	S	S
041	Bearings regreasable via grease nipples.	R	R	R	S	P	S	S	S
194	2Z-bearings at both ends, greased for lifetime.	S	S	S	R	S	M	R	-
042	Locked drive-end.	S	R	S	R	R	S	S	S
043	SPM-nipples.	-	M	M	M	P	S	S	S
058	Angular contact bearing at D-end, shaft force away from bearing.	R	R	R	-	-	P	P	P
107	Bearing mounted PT100 resistance elements.	-	-	-	-	-	P	P	P
433	Grease relief.	-	-	-	-	-	-	P	P
Brakes									
412	Built-on brake. Branch standard designs.	-	-	-	-	-	R	R	R
Branch standard designs									
142	"Manilla" winding connection. (440 VD series, 220 VD parallel, 60 Hz).	-	P	P	P	-	-	-	-
178	Stainless steel/acid proof bolts.	M	M	M	M	R	P	P	P
209	Non-standard voltage or frequency (special winding).	R	P	P	P	R	R	R	R
425	Corrosion protected stator and rotor core.	R	P	P	P	-	S	P	P
Cooling system									
068	Metal fan. Mandatory for ambient temperatures $\geq 60^\circ\text{C}$.	-	-	-	-	P	P	P	P
075	Cooling method IC 418 (without fan).	-	-	-	-	R	P	P	P
183	Separate motor cooling (fan axial, N-end).	-	-	-	-	-	R	R	R
422	Separate motor cooling (fan top or side, N-end).	-	-	-	-	-	-	R	R
791	Stainless steel fan cover.	-	-	-	-	-	R	R	R
Coupling									
035	Assembly of customer supplied coupling-half.	-	-	-	-	M	M	M	M
Drain holes									
065	Plugged drain holes.	-	S	S	S	P	P	P	P
066	Modified drain hole position (for specified IM xxxx).	M	-	-	-	P	P	P	P
076	Draining holes with plugs.	S	-	-	-	P	S	S	S
Hazardous environments									
272	EEx e design, temperature class T2.	R	R	R	R	P	P	P	P

¹⁾ Certain variant codes cannot be used simultaneously.

S = Included as standard.
M = On modification of a stocked motor,
or on new manufacture,
the number per order may be limited.

P = New manufacture only.
R = On request.
- = Not available

Variant codes / Increased safety motors		Aluminium motors				Cast iron motors			
Code ¹⁾	Variant	90-100	112-132	160-180	200-250	80-132	160-250	280-315	355-400
Heating elements									
450	Heating element, 110-120 V.	–	R	R	R	P	P	P	P
451	Heating element, 220-240 V.	–	R	R	R	P	P	P	P
Insulation system									
014	Winding insulation class H.	–	–	–	–	–	R	P	P
Marine motors									
See catalogue 'Marine Motors, BA/Marine GB', for details.									
Mounting arrangements									
008	IM 2101 foot/flange mounted, IEC flange, from IM 1001 (B34 from B3).	–	M	R	–	P	–	–	–
009	IM 2001 foot/flange mounted, IEC flange, from IM 1001 (B35 from B3).	–	M	M	M	P	M	M	M
047	IM 3601 flange mounted, IEC flange, from IM 3001 (B14 from B5), flange mounted with large flange. Small flange with tapped holes.	–	M	R	–	P	–	–	–
Painting									
114	Special paint colour, standard grade.	P	M	M	M	M	M	M	M
111	Offshore two-pack polyamide cured epoxy paint 160 µm	R	R	R	R	R	P	P	P
115	Offshore, zinc primer painting.	R	R	R	R	R	P	P	P
179	Special paint specification.	R	R	R	R	R	R	R	R
Protection									
072	Radial seal at D-end.	P	–	–	–	P	M	M	M
073	Sealed against oil at D-end.	–	–	–	–	R	P	P	P
005	Protective roof, vertical motor, shaft down.	M	S	S	S	M	M	M	M
158	Degree of protection IP 65.	–	R	R	R	P	M	P	P
211	Weather protected, IPwxx.	–	–	–	–	P	P	P	P
401	Protective roof, horizontal motor.	–	–	–	–	–	–	P	P
403	Degree of protection IP 56.	–	R	R	R	P	M	P	P
404	Degree of protection IP 56, without fan.	–	–	–	–	–	P	P	P
783	Labyrinth sealing at D-end.	–	–	–	–	R	P	P	P
Rating & instruction plates									
002	Restamping voltage, frequency and output, continuous duty.	–	–	–	–	–	–	–	–
095	Restamping output (maintained voltage, frequency), intermittent duty.	–	–	–	–	–	–	–	–
138	Mounting of additional identification plate.	M	M	M	M	R	M	M	M
139	Additional identification plate delivered loose.	M	M	M	M	R	M	M	M
150	Instruction plates and maintenance instructions in non-standard language.	–	–	–	–	R	R	R	R
161	Additional rating plate delivered loose.	M	M	M	M	P	M	M	M
Shaft & rotor									
069	Two shaft extensions as per basic catalogue.	P	P	P	P	P	P	P	P
070	One or two special shaft extensions, standard shaft material.	P	P	P	P	R	P	P	P
155	Cylindrical shaft extension, D-end, without key-way.	–	–	–	–	R	P	P	P
156	Cylindrical shaft extension, N-end, without key-way.	–	–	–	–	R	P	P	P
164	Shaft extension with closed key-way.	S	S	S	S	R	S	P	P
165	Shaft extension with open key-way.	–	P	P	P	R	P	S	S
410	Stainless/acid-proof steel shaft (standard or non-standard).	R	–	–	–	R	P	P	P

¹⁾ Certain variant codes cannot be used simultaneously.

S = Included as standard.
M = On modification of a stocked motor,
or on new manufacture,
the number per order may be limited.

P = New manufacture only.
R = On request.
– = Not available

Variant codes / Increased safety motors		Aluminium motors				Cast iron motors			
Code ¹⁾	Variant	90-100	112-132	160-180	200-250	80-132	160-250	280-315	355-400
Standards and regulations									
152	Classified shaft material.	-	-	-	-	P	P	P	P
421	VIK design (Verband der industriellen Energie- und Kraftwirtschaft e.V).	-	-	-	-	P	P	P	P
773	EEMUA No 132 1988 design.	-	-	-	-	R	R	P	P
774	NORSOK (North SeaTerritorial Waters) design.	-	-	-	-	R	R	P	P
775	SHELL DEP 33.66.05.31-Gen. January 1999 design.	-	-	-	-	R	R	P	P
Stator winding temperature sensors									
435	PTC - thermistors (3 in series), 130°C, in stator winding. Aluminium motors: only T3 motors.	P	R	M	M	P	S	S	S
436	PTC - thermistors (3 in series), 150°C, in stator winding.	P	R	M	S	-	-	-	-
439	PTC - thermistors (2x3 in series), 150°C, in stator winding.	-	R	M	M	-	-	-	-
440	PTC - thermistors (3 in series, 110°C and 3 in series, 130°C, in stator winding.	-	-	-	-	-	M	M	M
441	PTC - thermistors (3 in series 130°C & 3 in series 150°C) in stator winding.	-	R	M	M	-	-	-	-
445	PT100 resistance element (1 per phase) stator winding.	-	-	-	-	R	P	P	P
446	PT100 resistance element (2 per phase) stator winding.	-	-	-	-	R	P	P	P
Terminal box									
015	Δ connection in terminal box (reconnection from Y).	M	M	M	M	P	M	M	M
017	Y connection in terminal box (reconnection from Δ).	M	M	M	M	P	M	M	M
021	Terminal box LHS (seen from D-end).	-	-	-	P	R	P	P	P
136	Extended cable connection, standard terminal box. M2AA motors:2 m long connection cable.	-	-	-	-	-	R	R	R
137	Extended cable connection, low terminal box.	-	-	-	-	-	P	P	P
157	Terminal box degree of protection IP 65.	-	-	-	-	R	M	M	M
180	Terminal box RHS (seen from D-end).	-	-	-	P	R	P	P	P
400	4 x 90 degr turnable terminal box. Cast iron sizes 200-250 = S	-	-	-	-	-	S	P	P
402	Terminal box adapted for Al cables.	-	-	-	R	-	-	S	S
413	Extended cable connection, no terminal box.	-	-	-	-	-	-	P	P
418	Separate terminal box for temperature detectors.	R	R	R	R	-	P	P	P
466	Terminal box at N-end.	-	-	-	-	-	R	R	R
468	Non-standard cable entry direction (state cable direction)	-	-	-	-	P	P	P	P
469	Axial cable entry direction.	-	-	-	-	P	P	P	P
731	Non-standard cable glands.	-	-	-	-	R	M	M	M
736	Standard cable gland EEx e II, fulfilling EN 50014 and 50019.	-	-	-	-	P	S	S	S
737	Standard cable gland EEx e II with clamping device, fulfilling EN 50014 and 50019.	-	-	-	-	P	M	M	M
740	Prepared for PG cable glands.	-	-	-	-	P	P	P	P

¹⁾ Certain variant codes cannot be used simultaneously.

S = Included as standard.
M = On modification of a stocked motor,
or on new manufacture,
the number per order may be limited.

P = New manufacture only.
R = On request.
- = Not available

Variant codes / Increased safety motors		Aluminium motors				Cast iron motors			
Code ¹⁾	Variant	90-100	112-132	160-180	200-250	80-132	160-250	280-315	355-400
Testing									
140	Test confirmation.	M	M	M	M	–	–	–	–
145	Type test report from test of identical motor.	R	M	M	M	M	M	M	M
146	Type test with report for motor from specific delivery batch.	P	M	M	M	P	P	P	P
147	Type test with report for motor from specific delivery batch, customer witnessed.	P	M	M	M	P	P	P	P
148	Routine test report.	R	M	M	M	P	P	P	P
221	Type test and multi-point load test with report for motor from specific delivery batch.	–	M	M	M	P	P	P	P
222	Torque/speed curve, type test and multi-point load test with report from specific delivery batch.	–	M	M	M	P	P	P	P
760	Vibration level test.	R	M	M	M	P	P	P	P
761	Vibration spectrum test.	R	R	R	R	–	P	P	P
762	Noise level test.	R	M	M	M	P	P	P	P
763	Noise spectrum test.	R	R	R	R	P	P	P	P
764	Complete test with ABB frequency converter.	–	–	–	–	–	–	–	–
768	Chog type test with report for motor from specific delivery batch.	–	–	–	–	R	P	R	R
769	Chog type test report from test of identical motor.	–	–	–	–	R	P	R	R
Y/Δ-starting									
117	Terminals for Y/Δ start at both speeds (two-speed windings).	–	–	–	–	–	R	P	P
118	Terminals for Y/Δ start at high speed (two-speed windings).	–	–	–	–	–	R	P	P
119	Terminals for Y/Δ start at low speed (two-speed windings).	–	–	–	–	–	R	P	P

¹⁾ Certain variant codes cannot be used simultaneously.

S = Included as standard.
M = On modification of a stocked motor, or on new manufacture, the number per order may be limited.

P = New manufacture only.
R = On request.
– = Not available

Dimension drawings

M3000 Increased safety motors, aluminium frame

Foot-mounted motor IM 1001, IM B3

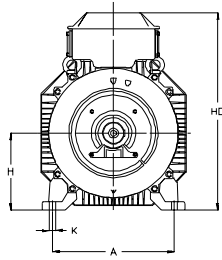
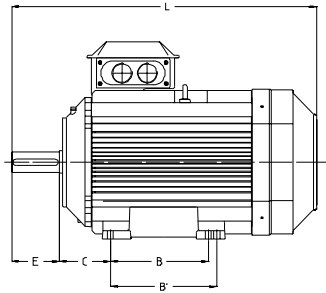

Flange-mounted motor IM 3001, IM B5

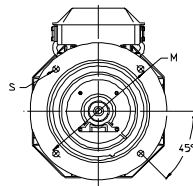
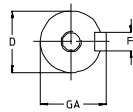
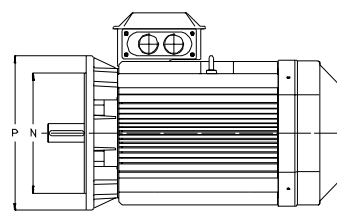

Flanges

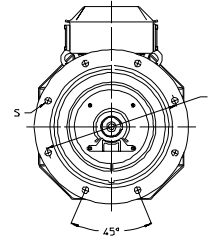

Sizes 90-200

Sizes 225-250

Motor size	IM 1001, IM B3 AND IM 3001, IM B5						IM 1001, IM B3						IM 3001, IM B5								
	D poles		GA poles		F poles		E poles		L max poles		A	B	B'	C	HD	K	H	M	N	P	S
	2	4-8	2	4-8	2	4-8	2	4-8	2	4-8											
90 S	24	24	27	27	8	8	50	50	295	295	140	100	—	56	212	10	90	165	130	200	12
90 L	24	24	27	27	8	8	50	50	320	320	140	125	—	56	212	10	90	165	130	200	12
100 L	28	28	31	31	8	8	60	60	358.5	358.5	160	140	—	63	236	12	100	215	180	250	15
112 M	28	28	31	8	8	8	60	60	361	361	190	140	—	70	258	12	112	215	180	250	14.5
132	38	41	41	41	10	10	80	80	447	447	216	140	178	89	295.5	12	132	265	230	300	14.5
160 ¹⁾	42	42	45	45	12	12	110	110	602.5	602.5	254	210	254	108	370	15	160	300	250	350	19
160 ²⁾	42	42	45	45	12	12	110	110	643.5	643.5	254	210	254	108	370	15	160	300	250	350	19
180 ³⁾	48	51.5	51.5	51.5	14	14	110	110	680	680	279	241	279	121	405	15	180	300	250	350	19
180 ⁴⁾	48	51.5	51.5	51.5	14	14	110	110	700.5	700.5	279	241	279	121	405	15	180	300	250	350	19
200 ML	55	55	59	59	16	16	110	110	773	773	318	267	305	133	496.5	18	200	350	300	400	19
225 SM	55	60	59	64	16	18	110	110	835	865	356	286	311	149	542	18	225	400	350	450	19
250 SM	60	65	64	69	18	18	140	140	872	872	406	311	349	168	590	22	250	500	450	550	19

IM 3601, IM B14

Motor size	HB	LA	M	N	P	S	T
90	122	14	115	95	140	M8	3
100	136	16	130	100	160	M8	3.5
112	146	20	130	110	160	M8	3.5
132	163.5	18	165	130	200	M10	3.5

Tolerances:

A, B	± 0,8
D, DA	ISO k6 < Ø 50mm ISO m6 > Ø 50mm
F, FA	ISO h9
H	+0 -0.5
N	ISO j6
C, CA	± 0.8

¹⁾ MA2, M2, L2, LB2, M4, L4, LB4, M6, L6, M28, M8

²⁾ LB6, L8, LB8

³⁾ M2, LB2, M4, L6, L8

⁴⁾ L4, LB4, LB6, LB8

Above table gives the main dimensions in mm.

For detailed drawings please check our web-pages 'www.abb.com/motors&drives' or contact ABB.

Dimension drawings

M3000 Increased safety motors, cast iron frame

Foot-mounted motor IM 1001, IM B3

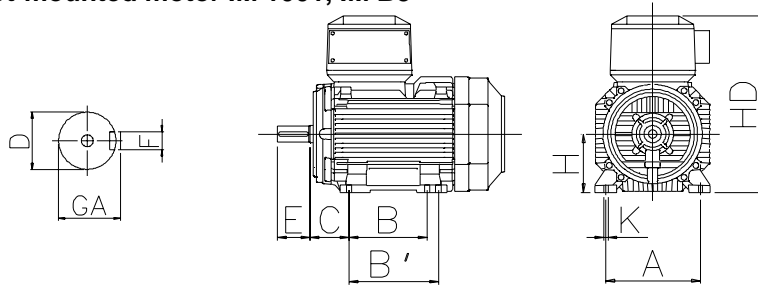

Protective roof, variant code 005

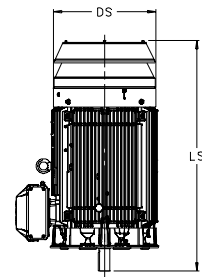

Flange-mounted motor IM 3001, IM B5

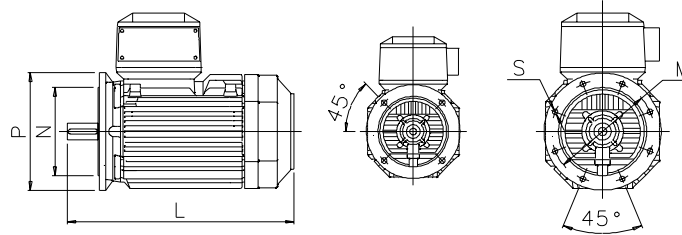

Sizes 80-200

Sizes 225-400

IM 1001, IM B3 AND IM 3001, IM B5							IM 1001, IM B3				IM 3001, IM B5				Protective roof									
Motor size	D poles		GA poles		F poles		E poles		L max poles	A	B	B'	C	HD	K	H	M	N	P	S	DS	LS poles		
	2	4-8	2	4-8	2	4-8	2	4-8														2	4-8	
80	19	19	21.5	21.5	6	6	40	40	273	273	125	100	-	50	221	9.5	80	165	130	200	11	150	306	306
90 S	24	24	27	27	8	8	50	50	301	301	140	100	-	56	240	9.5	90	165	130	200	11	170	360	360
90 L	24	24	27	27	8	8	50	50	326	326	140	125	-	56	240	9.5	90	165	130	200	11	170	360	360
100	28	28	31	31	8	8	60	60	378	378	160	140	-	63	260	11	100	215	180	250	13	188	425	425
112	28	28	31	31	8	8	60	60	414	414	190	140	-	70	281	11	112	215	180	250	13	188	444	444
132 S	38	38	41	41	10	10	80	80	454	454	216	140	-	89	344	11	132	265	230	300	14	255	548	548
132 M	38	38	41	41	10	10	80	80	492	492	216	178	-	89	344	11	132	265	230	300	14	255	548	548
160	42	42	45	45	12	12	110	110	711	711	254	210	254	108	388	14.5	160	300	250	350	18.5	328	756	756
180	48	48	51.5	51.5	14	14	110	110	706	706	279	241	279	121	426	14.5	180	300	250	350	18.5	359	756	756
200	55	55	59	59	16	16	110	110	774	774	318	267	305	133	536	18.5	200	350	300	400	18.5	414	844	844
225	55	60	59	64	16	18	110	140	841	871	356	286	311	149	583	18.5	225	400	350	450	18.5	462	921	951
250	60	65	64	69	18	18	140	140	875	875	406	311	349	168	646	24	250	500	450	550	18.5	506	965	965
280	65	75	69	79.5	18	20	140	140	1088	1088	457	368	419	190	762	24	280	500	450	550	18	555	1190	1190
315 SM	65	80	69	85	18	22	140	170	1174	1204	508	406	457	216	852	30	315	600	550	660	23	624	1290	1320
315 ML	65	90	69	95	18	25	140	170	1285	1315	508	457	508	216	852	30	315	600	550	660	23	624	1401	1431
355 S	70	100	74.5	106	20	28	140	210	1344	1414	610	500	-	254	955	35	355	740	680	800	23	590	1480	1550
355 SM	70	100	74.5	106	20	28	140	210	1396	1466	610	500	560	254	955	35	355	740	680	800	23	590	1530	1600
355 ML	70	100	74.5	106	20	28	140	210	1501	1571	610	560	630	254	955	35	355	740	680	800	23	590	1635	1705
400 M	70	100	74.5	106	20	28	140	210	1501	1571	686	630	-	280	1005	35	400	-	-	-	-	590	1635	1705
400 LK	80	100	85.0	106	22	28	170	210	1708	1748	686	710	800	280	1040	35	400	740	680	800	23	700	1860	1900

IM 3601, IM B14

Motor size	HB	LA	M	P	S	T
80	229	160	130	110	M8	R
90	236	200	165	130	M10	N
100	246	250	215	180	M12	N
112	256	300	265	230	M12	N

Tolerances:

- A, B ±0,8
- D, DA ISO k6 < Ø 50mm
ISO m6 > Ø 50mm
- F, FA ISO h9
- H +0 -0.5
- N ISO j6
- C, CA ±0.8

Above table gives the main dimensions in mm.
For detailed drawings please check our web-pages
'www.abb.com/motors&drives' or contact ABB.

Dimension drawings

Increased safety motors, cast iron frame

Terminal boxes, standard design with 6 terminals

Motor sizes 80 - 132 ¹⁾

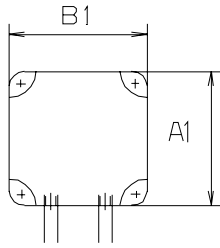

Motor sizes 160 - 250

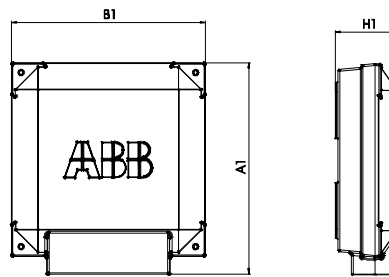

Motor sizes 280-315, top- and side-mounted
210/1, 370/1

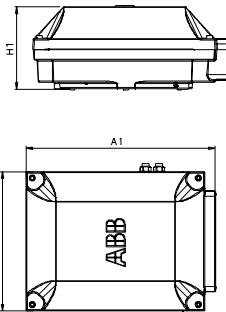

Motor sizes 355-400 top-mounted:
142/1, 142/2

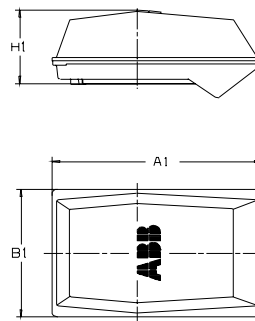

Motor sizes 355-400, top-mounted
162/1, 162/2 + adaptor MPMM-ZL1

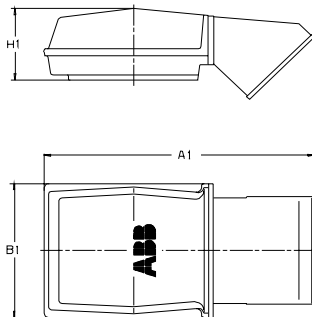

Motor sizes 355-400 side-mounted:
142/5, 142/10, 162/5, 162/8

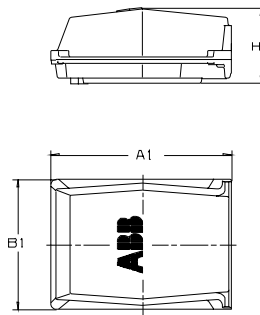

Motor size	A1	B1	H1
80 - 90	124	114	58
100 - 132	134	124	68
160 - 180	240	220	79.5
200 - 250	347.5	310	140.9

Terminal box type	Motor size	A1	B1	H1
210/1	280	416	306	177
370/1	315, 355	451	347	200
Top-mounted:				
142/1, 142/2	355-400	536	349	197
162/1, 162/2 + Adaptor MPMM-ZL1	355 - 400	787	410	226
Side-mounted:				
142/5, 142/10				
162/5, 162/8	355 - 400	508	412	226

For motor dimensions please see dimension drawings on earlier pages.

Increased safety motors with aluminium frame in brief, basic design

Motor size		90	100	112	132
Stator	Material	Die-cast aluminium alloy. Feet integrated with stator.		Die-cast aluminium alloy.	
	Surface treatment	Munsell blue 8B 4.5/3.25 / NCS 4822-B05G. Powder coating based on polyester resin, ≥ 60 µm		Polyester powder paint ≥ 50 µm	
Feet	Material	Aluminium alloy. Integrated with the stator.			
Bearing end shields	Material	Diecast aluminium alloy. Munsell blue 8B 4.5/3.25 / NCS 4822-B05G.			
	Surface treatment	One-component modified polyester paint. ≥ 30 µm		Polyester powder paint ≥ 50 µm	
Bearings Single-speed motors	D-end	6305-2Z/C3	6306-2Z/C3	6206-2Z/C3	6208-2Z/C3
	N-end	6204-2Z/C3	6205-2Z/C3	6205-2Z/C3	6206-2Z/C3
Axially-locked bearings	Inner bearing cover	D-end 112-132: Foot-mounted - a spring washer at N-end presses the rotor against D-end. Flange-mounted - inner bearing cover and spring-washer at N-end.			
Bearing seal	D-end N-end	V-ring. Labyrinth seal. Two-speed 112, 132 M, V-ring. Other labyrinth seal.			
Lubrication		Permanently lubricated bearings. Grease for bearing temperatures -40 to +160°C.			
Terminal box	Material	Die-cast aluminium alloy.			
	Surface treatment	Similar to stator.			
	Screws	Steel 5G. Galvanised and yellow chromated.			
Connections	Knock-out openings	4 x M20		4 x (M25 + M20)	
	Terminal box	Screw terminal. 6 terminals.		Cable lugs, 6 terminals.	
	Max Cu-area, mm ²	4		M5 / 10	
Fan	Material	Polypropylene. Reinforced with 20% glass fibre.			
Fan cover	Material	Polypropylene.			
Stator winding	Material Impregnation Insulation class Winding protection	Copper Polyester varnish. Tropicalised. Insulation class F. Temperature rise class B, unless otherwise stated. On request, see variant codes.			
Rotor winding	Material	Die-cast aluminium.			
Balancing method		Half key balancing.			
Key ways		Closed key way			
Enclosure		IP 55			
Cooling method		IC 411			
Drain holes		Drain holes with closable plastic plugs. Open on delivery.			

Increased safety motors with aluminium frame in brief, basic design

Motor size		160	180	200	225	250
Stator	Material	Die-cast aluminium alloy.		Extruded aluminium alloy.		
	Surface treatment	Polyester powder paint. Munsell blue 8B 4.5/3.25 / NCS 4822-B05G. $\geq 50 \mu\text{m}$.				
Feet	Material	Aluminium alloy. Integrated with the stator.		Aluminium alloy, bolted to the stator.		250-2, cast iron
		Flanged bearing end shields of cast iron, other die-cast aluminium alloy				
Bearing end shields	Material	Two-component oxiranester paint, Munsell blue 8B 4.5/3.25 / NCS 4822-B05G. $\geq 50 \mu\text{m}$.				
Bearings Single-speed motors	D-end	6309-2Z/C3	6310-2Z/C3	6312/C3	6313/C3	6315/C3
	N-end	6209-2Z/C3	6209-2Z/C3	6210/C3	6212/C3	6213/C3
Axially-locked bearings	Inner bearing cover	D-end	D-end	D-end	D-end	D-end
		V-ring. Labyrinth seal.		Outer and inner V-rings. Outer and inner V-rings.		
Bearing seal	D-end N-end					
Lubrication		Permanently lubricated bearings. Grease for bear. temp. -40 to +160°C.		Valve lubrication. Grease for bearing temperatures -40 to +150°C.		
Terminal box	Material	Die-cast aluminium alloy.		Deep-drawn steel sheet, bolted to stator.		
	Surface treatment	Base integrated with stator. Similar to stator.		Phosphated. Polyester paint.		
	Screws	Steel 5G. Galvanised and chromated.				
Connections	Knock-out openings	2 x (2 x M40 + M16)				
	Flange-openings			2 x FL 13.2 x M40		
	Flange-openings for voltage code S			2 x FL 21.2 x M63		
	Terminal box	Cable lugs. 6 terminals.				
	Max Cu-area, mm ²	M6 35	M6 35	M10 70	M10 70	M10 70
Fan	Material	Polypropylene. Reinforced with 20% glass fibre.				
Fan cover	Material	Steel sheet. ¹⁾ Also two-speed sizes 112 and 132 M.				
	Surface treatment	¹⁾ Phosphated. Polyester paint.				
Stator winding	Material	Copper				
	Impregnation	Polyester vanish. Tropicalised.				
	Insulation class	Insulation class F. Temperature rise class B, unless otherwise stated.				
	Winding protection	On request, see variant codes		PTC-thermistors, 150°C		
Rotor winding	Material	Die-cast aluminium.				
Balancing method		Half key balancing.				
Key way		Closed key way				
Enclosure		IP 55				
Cooling method		IC 411				
Drain holes		Drain holes with closable plastic plugs. Open on delivery.				

Increased safety motors with cast iron frame in brief, basic design

Motor size		80	90	100	112	132	160	180
Stator	Material	Cast iron EN-GJL-200						
	Paint colour shade	Blue, Munsell 8B 4.5/3.25 / NCS 4822 B05G						
	Paint thickness	Two-pack PUR-paint, thickness $\geq 60 \mu\text{m}$					Two-pack epoxy paint, thickness $\geq 80 \mu\text{m}$	
Bearing end shields	Material	Cast iron EN-GJL-150					Cast iron EN-GJL-200	
	Paint colour shade	Blue, Munsell 8B 4.5/3.25 / NCS 4822 B05G						
	Paint thickness	Two-pack PUR-paint, thickness $\geq 60 \mu\text{m}$					Two-pack epoxy paint, thickness $\geq 80 \mu\text{m}$	
Bearings	D-end 2-pole 4-12 -pole	6204-2Z/C3	6205-2Z/C3	6206-2Z/C3	6206-2Z/C3	6208-2Z/C3	6309M/C3 6309/C3	6310M/C3 6310/C3
	N-end 2-pole 4-12 -pole	6204-2Z/C3	6205-2Z/C3	6206-2Z/C3	6206-2Z/C3	6208-2Z/C3	6309M/C3 6309/C3	6309M/C3 6309/C3
Axially-locked bearings	Inner bearing cover	On request					As standard, locked at D-end	
Bearing seal		2RS-integral seals					Gamma ring as standard, radial seal on request	
Lubrication		Permanent grease lubrication.					Regreasable bearings as standard, lifetime lubrication as option	
SPM-nipples		–					As standard	
Rating plate	Material	Stainless steel 0.80 Cr 18 Ni9					Stainless steel	
Terminal box	Frame material	Cast iron EN-GJL-150					Cast iron EN-GJL-200	
	Cover material	Cast iron EN-GJL-150					Cast iron EN-GJL-200	
	Cover screws material	Steel 5G, coated with zinc and yellow cromated						
Connections	Cable entries	2xM25x1.5	2xM25x1.5	2xM32x1.5	2xM32x1.5	2xM32x1.5	2xM40x1.5	2xM40x1.5
	Terminals	6 terminals for connection with cable lugs (not included)						
Fan	Material	Reinforced glass fiber						
Fan cover	Material	Steel					Zinc coated steel	
	Paint colour shade	Blue, Munsell 8B 4.5/3.25 / NCS 4822 B05G						
	Paint thickness	Two-pack PUR-paint, thickness $\geq 60 \mu\text{m}$					Polyester powder paint, thickness $\geq 80 \mu\text{m}$	
Stator winding	Material	Copper						
	Insulation	Insulation class F						
	Winding protection	On request					3 pcs thermistors	
Rotor winding	Material	Pressure die-cast aluminium						
Balancing method		Half key balancing						
Key ways		Open key way					Closed key-way	
Drain holes		Optional, see variant codes					As standard open on delivery	
External earthing		External earthing bolt						
Enclosure		IP 55, higher protection on request						
Cooling method		IC 411						

Increased safety motors with cast iron frame in brief, basic design

Motor size		200	225	250	280	315	355	400	
Stator	Material	Cast iron EN-GJL-200			Cast iron EN-GJL-200				
	Paint colour shade	Blue, Munsell 8B 4.5/3.25 / NCS 4822			B05G				
	Paint thickness	Two-pack epoxy paint, thickness $\geq 80 \mu\text{m}$							
Bearing end shields	Material	Cast iron EN-GJL-200			Cast iron EN-GJL-200, except flange-mounted sizes 355-400 Spheroidal graphit EN-GJS-400				
	Paint colour shade	Blue, Munsell 8B 4.5/3.25 / NCS 4822			B05G				
	Paint thickness	Two-pack epoxy paint, thickness $\geq 70 \mu\text{m}$							
Bearings	D-end 2-pole	6312M/C3	6313M/C3	6315M/C3	6316/C3	6316/C3	6319M/C4	6319M/C4	
	4-12 -pole	6312/C3	6313/C3	6315/C3	6316/C3	6319/C3	6322/C3	6322/C3	
	N-end 2-pole	6310M/C3	6312M/C3	6313M/C3	6316/C3	6316/C3	6319M/C4	6319M/C4	
	4-12 -pole	6310/C3	6312/C3	6313/C3	6316/C3	6316/C3	6319/C3	6319/C3	
Axially-locked bearings	Inner bearing cover	As standard, locked at D-end							
Bearing seals		Gamma ring as standard, radial seal on request			V-ring as standard, radial seal on request				
Lubrication		Regreasable bearings as standard, lifetime lubrication as option			Regreasable bearings, regreasing nipples, M10x1				
SPM-nipples		As standard			Optional		As standard		
Rating plate	Material	Stainless steel							
Terminal box	Frame material	Cast iron EN-GJL-200							
	Cover material	Cast iron EN-GJL-200							
	Cover screws material	Steel 5G, coated with zinc and yellow cromated							
Connections	Cable-entries 2-4 pole	2xM50x1.5	2xM50x1.5	2xM63x1.5	2xM63x1.5	2xM63x1.5	2xØ60/80	2xØ80	
	6-8 pole						2xØ60	2xØ60/80	
	Terminals	6 terminals for connection with cable lugs (not included)							
Fan	Material	Reinforced glass fiber laminate or aluminium			Reinforced glass fiber, aluminium or polypropylene with metal hub				
Fan cover	Material	Zinc coated steel			Steel				
	Paint colour shade	Blue, Munsell 8B 4.5/3.25 / NCS 4822			B05G				
	Paint thickness	Two-pack epoxy polyester paint, thickness $\geq 80 \mu\text{m}$							
Stator winding	Material	Copper							
	Insulation	Insulation class F							
	Winding protection	3 pcs thermistors							
Rotor winding	Material	Pressure die-cast aluminium			Pressure die-cast aluminium or copper				
Balancing method		Half key balancing							
Key way		Closed key way			Open key way				
Drain holes		As standard, open on delivery							
External earthing		External earthing bolt as standard							
Enclosure		IP 55, higher protection on request							
Cooling method		IC 411							

Non-sparking EEx nA, Ex nA, Ex N

Range

	Standards	Frame	Size	Output range
Non-sparking Ex nA	IEC 60079-15	aluminium cast iron	90 - 250 71 - 400	1.1 - 75 kW 0.25 - 630 kW
Non-sparking Ex N	BS 5000:16	aluminium cast iron	112 - 250 280 - 400	4 - 75 kW 75 - 630 kW
Non-sparking EEx nA	EN 50021	cast iron	71- 315	0.25 - 200 kW

Terminal boxes

Terminal boxes are mounted on the top of the basic motor versions. The terminal box can also be placed on either side of the motor besides on cast iron 160 to 250 motors. The terminal box is either rotatable or at least allows cable entry from either side which gives a choice of connection possibilities.

Protection class of the standard terminal box is IP 55.

Aluminium motors

In sizes 90 to 180 the terminal box is made of aluminium, the bottom section is integrated with the stator and provided with two openings on both sides. Cable glands are not supplied.

In sizes 200 to 250 the terminal box and cover are made of deep drawn steel, bolted to the stator. The

terminal box is provided with two flange openings, one on each side. Cable glands are not supplied.

Cast iron motors

The terminal boxes in motors 71-132 and 200-250 are 4x90° turnable as standard, in motor sizes 160 to 180 and 280-400 as standard 2x180° and as easy option 4x90°.

In sizes 80 to 132 the motors are provided with cast iron terminal boxes with tapped cable entry holes on one side. Cable glands can be provided on request, see variant codes. In motor sizes 160 to 400 the cast iron terminal box is equipped with cable glands or cable boxes as standard.

Co-ordination of terminal boxes and cable entries

If no ordering information on the cable is given, it is assumed to be p.v.c. -insulated and termination parts are supplied according to the following tables.

Aluminium motors sizes 90-180 and cast iron motors sizes 160-250 are as standard fitted with metric threads.

Motor sizes 90-250 with aluminium frame

Voltage 220 - 690 V, 50 Hz

Motor size	Opening	Metric cable entry	Comparison Pg gland	Cable diameter mm, min-max.	Max. connection cable area mm ²	Terminal bolt size 6 x
90-100	¹⁾	4 x M20	4 x Pg 16	2x Ø8-13	4	M4
112-132	¹⁾	M25 + M20	2 x (Pg 21 + Pg 16)	2x Ø11-17	10	M5
160-180	¹⁾	2 x M40 + M12	4 x Pg 29 + 2 x Pg 9	2x Ø19-27	35	M6
200-250	2 x FL 13	2 x M63 + M12	2 x Pg 29	2x Ø19-27	70	M10

¹⁾ Knockout openings

Motor sizes 71-250 with cast iron frame

Motor size	Metric cable entry	Comparison Pg gland	Cable gland diameter mm, min-max.	Max. connection cable area mm ²	Terminal bolt size 6 x
71	2 x M16	2 x Pg 11	2x Ø5-10	6	M4
80-90	2 x M25	2 x Pg 16	2x Ø8-13	6	M4
100-112	2 x M32	2 x Pg 21	2x Ø15-20	16	M5
132	2 x M32	2 x Pg 21	2x Ø15-20	16	M5
160	2 x M40 x 1.5 + 2 x M20 x 1.5	2 x Pg 29 + 2 x Pg 13.5	2x Ø18-27	25	M6
180	2 x M40 x 1.5 + 2 x M20 x 1.5	2 x Pg 29 + 2 x Pg 13.5	2x Ø18-27	25	M6
200	2 x M50 x 1.5 + 2 x M20 x 1.5	2 x Pg 36 + 2 x Pg 13.5	2x Ø26-35	35	M10
225	2 x M50 x 1.5 + 2 x M20 x 1.5	2 x Pg 36 + 2 x Pg 13.5	2x Ø26-35	50	M10
250	2 x M63 x 1.5 + 2 x M20 x 1.5	2 x Pg 42 + 2 x Pg 13.5	2x Ø32-49	70	M10

Co-ordination of terminal boxes and cable entries

Cast iron motors sizes 280-400 motors with top-mounted terminal box

Motor size	Flange or adapter	Cable box or cable gland	Gland thread	Cable diameter	Max. connection cable area mm ²	Terminal bolt size	Voltage/frequency code
3000 r/min (2 poles)							
280	3GZF 294 730-749	2x 3GZF 294 730-613	2x M63x1.5	2x Ø32-49	2x150	M12	
315	3GZF 294 730-753	2x 3GZF 294 730-613	2x M63x1.5	2x Ø32-49	2x240	M12	
355 S	MPMM-ZL1	3GZF 294 730-301		2x Ø48-60	4x240	M12	D
	-	3GZF 294 730-301		2x Ø48-60	2x240	M12	E
355 SM ₋	MPMM-ZL1	3GZF 294 730-301		2x Ø48-60	4x240	M12	
355 ML ₋	MPMM-ZL1	LNPB 3328		2x Ø60-80	4x240	M12	
400 M ₋	MPMM-ZL1	LNPB 3328		2x Ø60-80	4x240	M12	
400 LK ₋	MPMM-ZL1	LNPB 3328		2x Ø60-80	4x240	M12	
1500 r/min (4 poles)							
280	3GZF 294 730-749	2x 3GZF 294 730-613	2x M63x1.5	2x Ø32-49	2x150	M12	
315	3GZF 294 730-753	2x 3GZF 294 730-613	2x M63x1.5	2x Ø32-49	2x240	M12	
355 S	MPMM-ZL1	3GZF 294 730-301		2x Ø48-60	4x240	M12	D
	-	3GZF 294 730-301		2x Ø48-60	2x240	M12	E
355 SM ₋	MPMM-ZL1	3GZF 294 730-301		2x Ø48-60	4x240	M12	
355 ML ₋	MPMM-ZL1	LNPB 3328		2x Ø60-80	4x240	M12	
400 M ₋	MPMM-ZL1	LNPB 3328		2x Ø60-80	4x240	M12	
400 LKA	MPMM-ZL1	LNPB 3328		2x Ø60-80	4x240	M12	D
	MPMM-ZL1	LNPB 3328		2x Ø60-80	4x240	M12	E
400 LKB, LKC	MPMM-ZL1	LNPB 3328		2x Ø60-80	4x240	M12	
1000 r/min (6 poles)							
280	3GZF 294 730-749	2x 3GZF 294 730-613	2x M63x1.5	2x Ø32-49	2x150	M12	
315	3GZF 294 730-753	2x 3GZF 294 730-613	2x M63x1.5	2x Ø32-49	2x240	M12	
355 S, SMA	-	3GZF 294 730-301		2x Ø48-60	2x240	M12	
355 SMB	MPMM-ZL1	3GZF 294 730-301		2x Ø48-60	4x240	M12	D
	-	3GZF 294 730-301		2x Ø48-60	2x240	M12	E
355 ML ₋	MPMM-ZL1	3GZF 294 730-301		2x Ø48-60	4x240	M12	
400 M	MPMM-ZL1	LNPB 3328		2x Ø60-80	4x240	M12	D
	-	3GZF 294 730-301		2x Ø48-60	2x240	M12	E
400 MA, MB	MPMM-ZL1	LNPB 3328		2x Ø60-80	4x240	M12	
400 LKA	MPMM-ZL1	LNPB 3328		2x Ø60-80	4x240	M12	
400 LKB, LKC	MPMM-ZL1	LNPB 3328		2x Ø60-80	4x240	M12	D
	MPMM-ZL1	LNPB 3328		2x Ø60-80	4x240	M12	E
750 r/min (8 poles)							
280	3GZF 294 730-749	2x 3GZF 294 730-613	2x M63x1.5	2x Ø32-49	2x150	M12	
315	3GZF 294 730-753	2x 3GZF 294 730-613	2x M63x1.5	2x Ø32-49	2x240	M12	
355 S, SMA	-	3GZF 294 730-301		2x Ø48-60	2x240	M12	
355 MLA	-	3GZF 294 730-301		2x Ø48-60	2x240	M12	
355 MLC	MPMM-ZL1	3GZF 294 730-301		2x Ø48-60	4x240	M12	D
	-	3GZF 294 730-301		2x Ø48-60	2x240	M12	E
400 M	-	3GZF 294 730-301		2x Ø48-60	2x240	M12	D
400 MA	MPMM-ZL1	3GZF 294 730-301		2x Ø48-60	4x240	M12	D
	-	3GZF 294 730-301		2x Ø48-60	2x240	M12	E
400 LK ₋	MPMM-ZL1	LNPB 3328		2x Ø60-80	4x240	M12	

Voltage/frequency codes:

D - 380-420 VΔ 50 Hz, 660-690 VY 50 Hz, 440-480 VΔ 60 Hz

E - 500 VΔ 50 Hz, 575 VΔ 60 Hz

Examples:

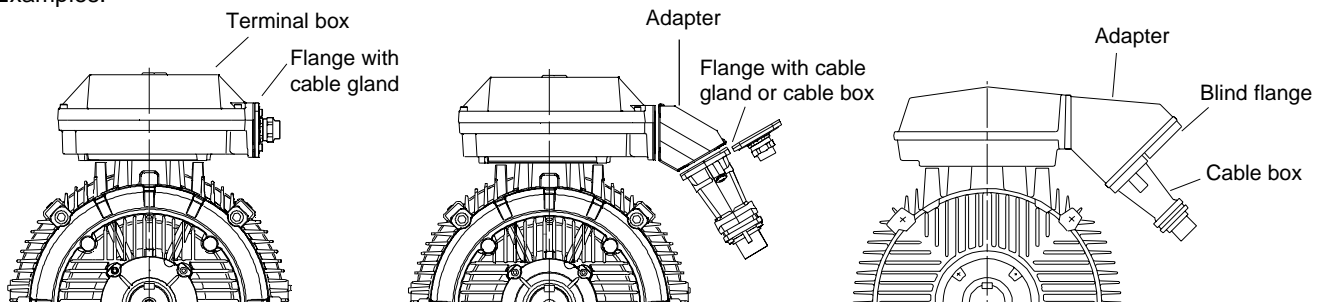

Co-ordination of terminal boxes and cable entries

Cast iron motors sizes 280-400 motors with side-mounted terminal box

Motor size	Flange or adapter	Cable box or cable gland	Gland thread	Cable diameter	Max. connection cable area mm ²	Terminal bolt size	Voltage/frequency code
3000 r/min (2 poles)							
280	3GZF 294 730-749	2x 3GZF 294 730-613	2x M63x1.5	2x Ø32-49	2x150	M12	
315	3GZF 294 730-753	2x 3GZF 294 730-613	2x M63x1.5	2x Ø32-49	2x240	M12	
355 S	3GZF 294 730-759	3GZF 294 730-301		2x Ø48-60	4x240	M12	D
	-	3GZF 294 730-301		2x Ø48-60	2x240	M12	E
355 SM_	3GZF 294 730-759	3GZF 294 730-301		2x Ø48-60	4x240	M12	
355 ML_	3GZF 294 730-759	LNPB 3328		2x Ø60-80	4x240	M12	
400 M_	3GZF 294 730-759	LNPB 3328		2x Ø60-80	4x240	M12	
400 LK_	3GZF 294 730-759	LNPB 3328		2x Ø60-80	4x240	M12	
1500 r/min (4 poles)							
280	3GZF 294 730-749	2x 3GZF 294 730-613	2x M63x1.5	2x Ø32-49	2x150	M12	
315	3GZF 294 730-753	2x 3GZF 294 730-613	2x M63x1.5	2x Ø32-49	2x240	M12	
355 S	3GZF 294 730-759	3GZF 294 730-301		2x Ø48-60	4x240	M12	D
	-	3GZF 294 730-301		2x Ø48-60	2x240	M12	E
355 SM_	3GZF 294 730-759	3GZF 294 730-301		2x Ø48-60	4x240	M12	
355 ML_	3GZF 294 730-759	LNPB 3328		2x Ø60-80	4x240	M12	
400 M_	3GZF 294 730-759	LNPB 3328		2x Ø60-80	4x240	M12	
400 LKA	3GZF 294 730-759	LNPB 3328		2x Ø60-80	4x240	M12	D
	3GZF 294 730-759	LNPB 3328		2x Ø60-80	4x240	M12	E
400 LKB, LKC	3GZF 294 730-759	LNPB 3328		2x Ø60-80	4x240	M12	
1000 r/min (6 poles)							
280	3GZF 294 730-749	2x 3GZF 294 730-613	2x M63x1.5	2x Ø32-49	2x150	M12	
315	3GZF 294 730-753	2x 3GZF 294 730-613	2x M63x1.5	2x Ø32-49	2x240	M12	
355 S	-	3GZF 294 730-301		2x Ø48-60	2x240	M12	
355 SMB	3GZF 294 730-759	3GZF 294 730-301		2x Ø48-60	4x240	M12	D
	-	3GZF 294 730-301		2x Ø48-60	2x240	M12	E
355 MLA	3GZF 294 730-759	3GZF 294 730-301		2x Ø48-60	4x240	M12	
400 M	3GZF 294 730-759	LNPB 3328		2x Ø60-80	4x240	M12	D
	-	3GZF 294 730-301		2x Ø48-60	2x240	M12	E
400 MA, MB	3GZF 294 730-759	LNPB 3328		2x Ø60-80	4x240	M12	
400 LKA	3GZF 294 730-759	LNPB 3328		2x Ø60-80	4x240	M12	
400 LKB, LKC	3GZF 294 730-759	LNPB 3328		2x Ø60-80	4x240	M12	D
	3GZF 294 730-759	LNPB 3328		2x Ø60-80	4x240	M12	E
750 r/min (8 poles)							
280	3GZF 294 730-749	2x 3GZF 294 730-613	2x M63x1.5	2x Ø32-49	2x150	M12	
315	3GZF 294 730-753	2x 3GZF 294 730-613	2x M63x1.5	2x Ø32-49	2x240	M12	
355 S	-	3GZF 294 730-301		2x Ø48-60	2x240	M12	
355 MLA	-	3GZF 294 730-301		2x Ø48-60	2x240	M12	
355 MLC	3GZF 294 730-759	3GZF 294 730-301		2x Ø48-60	4x240	M12	D
	-	3GZF 294 730-301		2x Ø48-60	2x240	M12	E
400 M	-	3GZF 294 730-301		2x Ø48-60	2x240	M12	D
400 MA	3GZF 294 730-759	3GZF 294 730-301		2x Ø48-60	4x240	M12	D
	-	3GZF 294 730-301		2x Ø48-60	2x240	M12	E
400 LK_	3GZF 294 730-759	LNPB 3328		2x Ø60-80	4x240	M12	

Voltage/frequency codes:

D - 380-420 VΔ 50 Hz, 660-690 VY 50 Hz, 440-480 VΔ 60 Hz

E - 500 VΔ 50 Hz, 575 VΔ 60 Hz

Examples:

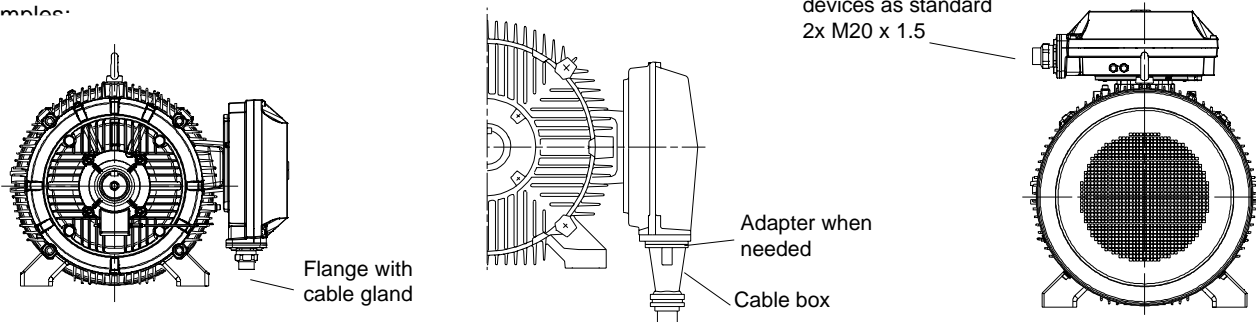

Technical data – Non-sparking motors

Aluminium frame, sizes 90 to 250



IP 55, IC 411; Insulation class F, temperature rise class B

Output kW		Type designa	Product code	Speed r/min	Efficiency		Power factor cos φ	Current		Torque			Moment of inertia J=1/4 GD ²		Sound pressure level LP dB(A)	
400V 50Hz	440V 60Hz				Full load 100%	3/4 load 75%		I _N A	I _s I _N	T _N Nm	T _s T _N	T _{max} T _N	kgm ²	Weight kg		
3000 r/min = 2 poles				400 V 50 Hz				Basic design								
1.5	1.75	M3AAN90 S	3GAA 091 001-••A	2870	80.1	76.2	0.82	3.35	5.5	5	2.4	3.0	0.0019	13	63	
2.2	2.5	M3AAN90 L	3GAA 091 002-••A	2880	83.6	79.0	0.87	4.37	7.0	7.5	2.7	3.0	0.0024	16	63	
3	3.5	M3AAN100 L	3GAA 101 001-••A	2900	86.0	84.1	0.88	5.95	7.5	10	2.7	3.6	0.0041	21	65	
4	4.6	M3AA 112 M	3GAA 111 001-••C	2850	86.0	86.0	0.91	7.4	7.5	13.4	2.8	3.0	0.01	25	63	
5.5	6.4	M3AA 132 SA	3GAA 131 001-••C	2855	86.0	86.0	0.88	10.5	7.8	18.4	3.2	3.4	0.014	37	69	
7.5	8.6	M3AA 132 SB	3GAA 131 002-••C	2855	87.0	87.0	0.90	13.9	8.5	25	3.4	3.6	0.016	42	69	
11	12.5	M3AA 160 MA	3GAA 161 101-••C	2930	91.2	92.1	0.88	20	6.3	36	1.9	2.5	0.039	73	69	
15	17	M3AA 160 M	3GAA 161 102-••C	2920	91.7	91.7	0.90	26.5	6.6	49	2.3	2.5	0.047	84	69	
18.5	21	M3AA 160 L	3GAA 161 103-••C	2920	92.4	92.4	0.91	32	7.3	60	2.6	2.7	0.053	94	69	
22	25	M3AA 180 M	3GAA 181 101-••C	2930	92.8	92.8	0.89	38.5	7.2	71	2.5	2.7	0.077	119	69	
30	35	M3AA 200 MLA	3GAA 201 001-••C	2955	93.2	93.2	0.88	53	7.3	97	2.4	3.1	0.15	175	72	
37	43	M3AA 200 MLB	3GAA 201 002-••C	2950	93.6	93.6	0.89	64	7.3	120	2.5	3.2	0.18	200	72	
45	52	M3AA 225 SMB	3GAA 221 001-••C	2960	93.9	93.9	0.88	79	7.3	145	2.5	2.8	0.26	235	74	
55	63	M3AA 250 SMA	3GAA 251 001-••C	2970	94.4	94.4	0.89	95	7.5	177	2.0	3.0	0.49	285	75	
3000 r/min = 2 poles				400 V 50 Hz				High-output design								
2.7	3	¹⁾ M3AAN90 LB	3GAA 091 003-••A	2860	80.7	83.5	0.86	5.7	7.0	9	2.6	3.0	0.0027	18	63	
4	4.6	¹⁾ M3AAN100 LB	3GAA 101 002-••A	2900	85.0	84.3	0.86	8.1	7.5	13	2.7	3.6	0.005	25	68	
5.5	6.4	¹⁾ M3AA 112 MB	3GAA 111 002-••C	2855	86.5	86.5	0.93	9.9	7.3	18.4	2.7	2.9	0.012	33	63	
11	12.6	¹⁾ M3AA 132 SC	3GAA 131 003-••C	2835	87.0	87.0	0.93	19.6	8.0	37	3.2	3.3	0.022	56	69	
22	25	¹⁾ M3AA 160 LB	3GAA 161 104-••C	2920	92.1	92.1	0.91	38	7.1	72	2.6	2.6	0.058	100	69	
30	35	¹⁾ M3AA 180 LB	3GAA 181 102-••C	2945	93.7	93.7	0.89	53	8.3	97	3.1	3.4	0.92	137	70	
45	52	¹⁾ M3AA 200 MLC	3GAA 201 003-••C	2950	93.8	93.8	0.89	78	7.3	146	2.6	3.3	0.19	205	72	
55	63	M3AA 225 SMC	3GAA 221 002-••C	2960	94.3	94.3	0.89	95	7.0	177	2.5	2.9	0.29	260	74	
75	86	M3AA 250 SMB	3GAA 251 002-••C	2970	95.2	95.2	0.90	127	7.3	241	2.1	3.0	0.57	330	75	

¹⁾Temperature rise acc. to class F.

Note: When placing orders for frame sizes 90-100, the variant code +094 should be added.

Data for other voltages on request.

During the transition period some motor types belonging to M3000 range still have the old product codes and type designations. Always check the valid code before ordering.

The two bullets in the product code indicate choice of mounting arrangement (see ordering information), voltage and frequency (below).

Motor size	S		D		H	E	F	T	U	X
	50 Hz	60 Hz	50 Hz	60 Hz	50 Hz	50 Hz	50 Hz	50 Hz	50 Hz	
90-100	220-230 VΔ		380-400 VΔ	440-460 VΔ	–	500 VΔ	500 VY	–	–	Other rated voltage, connection or frequency, 690 V maximum (500 V maximum for frame sizes 90-100)
	380-400 VY	440-460 VY	660-690 VY	–						
112-132	220-240 VΔ	–	380-420 VΔ	440-480 VΔ	415 VΔ	500 VΔ	–	660 VΔ	690 VΔ	
	380-420 VY	440-480 VY	660-690 VY	–						
160-250	220,230 VΔ	–	380,400,415 VΔ	440 VΔ	415 VΔ	500 VΔ	–	660 VΔ	690 VΔ	
	380,400,415 VY	440 VY	660-690 VY	–						

Technical data – Non-sparking motors

Aluminium frame, sizes 90 to 250



IP 55, IC 411; Insulation class F, temperature rise class B

Output				Product code	Speed r/min	Efficiency		Power factor cos φ	Current		Torque			Moment of inertia J=1/4 GD ² kgm ²	Weight kg	Sound pressure level LP dB(A)
400V 50Hz	440V 60Hz	Type designation	Full load 100%			3/4 load 75%	I _N A		I _s I _N	T _N Nm	T _s T _N	T _{max} T _N				

1500 r/min = 4 poles				400 V 50 Hz				Basic design								
1.1	1.3	M3AAN 90 S	3GAA 092 001-**-A	1410	77.5	76.4	0.81	2.59	5.0	7.5	2.2	2.7	0.0032	13	50	
1.5	1.75	M3AAN 90 L	3GAA 092 002-**-A	1420	80.3	78.1	0.79	3.45	5.0	10	2.4	2.9	0.0043	16	50	
2.2	2.5	M3AAN 100 LA	3GAA 102 001-**-A	1430	83.0	82.7	0.81	4.8	5.5	15	2.4	2.9	0.0069	21	64	
3	3.5	M3AAN 100 LB	3GAA 102 002-**-A	1430	85.0	83.9	0.81	6.48	5.5	20	2.5	2.9	0.0082	24	66	
4	4.6	M3AA 112 M	3GAA 112 001-**-C	1435	84.5	85.5	0.80	8.6	7.0	27	2.8	3.0	0.015	27	56	
5.5	6.4	M3AA 132 S	3GAA 132 001-**-C	1450	87.0	87.0	0.83	11.1	7.3	36	2.2	3.0	0.031	40	59	
7.5	8.6	M3AA 132 M	3GAA 132 002-**-C	1450	88.0	88.0	0.83	14.8	7.9	49	2.5	3.2	0.038	48	59	
11	12.5	M3AA 160 M	3GAA 162 101-**-C	1460	90.3	90.3	0.81	21.5	6.7	72	2.9	2.8	0.067	75	62	
15	17	M3AA 160 L	3GAA 162 102-**-C	1455	91.1	91.1	0.84	28.5	6.8	98	3.0	2.8	0.091	94	62	
18.5	21	M3AA 180 M	3GAA 182 101-**-C	1470	92.3	92.3	0.84	35	7.0	120	3.1	2.7	0.161	124	62	
22	25	M3AA 180 L	3GAA 182 102-**-C	1470	92.4	92.4	0.83	41	7.0	143	2.9	2.8	0.191	141	63	
30	35	M3AA 200 MLA	3GAA 202 001-**-C	1475	92.9	92.9	0.83	56	7.3	194	3.7	2.8	0.29	180	63	
37	42	M3AA 225 SMA	3GAA 222 001-**-C	1480	93.6	93.6	0.84	68	6.6	239	2.4	2.5	0.37	215	66	
45	52	M3AA 225 SMB	3GAA 222 002-**-C	1480	94.2	94.2	0.83	83	6.7	290	2.7	2.6	0.42	230	66	
55	63	M3AA 250 SMA	3GAA 252 001-**-C	1480	94.6	94.6	0.86	98	7.5	355	2.3	2.8	0.72	275	67	

1500 r/min = 4 poles				400 V 50 Hz				High-output design								
1.85	2.2	¹⁾ M3AAN 90 L	3GAA 092 003-**-A	1390	79.5	78.1	0.80	4.4	4.5	13	2.2	2.4	0.0043	16	50	
2.2	2.5	¹⁾ M3AAN 90 LB	3GAA 092 004-**-A	1390	80.3	81.0	0.83	4.85	4.5	15	2.2	2.4	0.0048	17	50	
4	4.6	¹⁾ M3AAN 100 LC	3GAA 102 003-**-A	1420	81.0	81.7	0.82	8.65	5.5	27	2.5	2.8	0.009	25	60	
5.5	6.4	¹⁾ M3AA 112 MB	3GAA 112 002-**-C	1425	84.5	85.5	0.83	11.4	7.1	37	2.8	3.1	0.018	34	56	
11	12.6	¹⁾ M3AA 132 MB	3GAA 132 003-**-C	1450	88.0	88.0	0.86	21	8.3	72	3.0	2.7	0.048	59	59	
18.5	21	¹⁾ M3AA 160 LB	3GAA 162 103-**-C	1450	90.5	90.5	0.84	36	6.9	122	2.9	2.9	0.102	103	63	
30	35	¹⁾ M3AA 180 LB	3GAA 182 103-**-C	1465	92.5	92.5	0.84	56	6.9	195	3.2	2.8	0.225	161	63	
37	42	M3AA 200 MLB	3GAA 202 002-**-C	1475	93.4	93.4	0.84	68	7.8	236	3.6	3.2	0.34	205	63	
55	63	M3AA 225 SMC	3GAA 222 003-**-C	1480	94.6	94.6	0.84	100	7.3	355	3.1	2.8	0.49	265	66	
75	86	M3AA 250 SMB	3GAA 252 002-**-C	1480	95.0	95.0	0.86	132	7.0	484	2.4	3.0	0.88	335	67	

¹⁾ Temperature rise acc. to class F.

Note: When placing orders for frame sizes 90-100, the variant code +094 should be added.

Data for other voltages on request.

During the transition period some motor types belonging to M3000 range still have the old product codes and type designations. Always check the valid code before ordering.

The two bullets in the product code indicate choice of mounting arrangement (see ordering information), voltage and frequency (below).

Motor size	S		D		H	E	F	T	U	X
	50 Hz	60 Hz	50 Hz	60 Hz						
90-100	220-230 VΔ		380-400 VΔ	440-460 VΔ	–	500 VΔ	500 VY	–	–	Other rated voltage, connection or frequency, 690 V maximum (500 V maximum for frame sizes 90-100)
	380-400 VY	440-460 VY	660-690 VY	–						
112-132	220-240 VΔ	–	380-420 VΔ	440-480 VΔ	415 VΔ	500 VΔ	–	660 VΔ	690 VΔ	
	380-420 VY	440-480 VY	660-690 VY	–						
160-250	220,230 VΔ	–	380,400,415 VΔ	440 VΔ	415 VΔ	500 VΔ	–	660 VΔ	690 VΔ	
	380,400,415 VY	440 VY	660-690 VY	–						

Technical data – Non-sparking motors

Aluminium frame, sizes 90 to 250



IP 55, IC 411; Insulation class F, temperature rise class B

Output				Efficiency			Power factor	Current		Torque			Moment of inertia		Sound pressure level LP		
kW		Type	Product	Speed	Full load	3/4 load		I_N	I_s	T_N	T_s	T_{max}	$J=1/4 GD^2$	Weight			
400V	440V	50Hz	60Hz	designa- tion	code	r/min	100%	75%	cos φ	A	I_N	Nm	T_N	T_N	kgm ²	kg	dB(A)
				1000 r/min = 6 poles				400 V 50 Hz				Basic design					
0.75	0.9			M3AAN90 S	3GAA 093 001-••A	930	71.5	70.7	0.67	2.36	4.0	7.5	1.9	2.3	0.0032	13	44
1.1	1.3			M3AAN90 L	3GAA 093 002-••A	930	74.4	72.5	0.69	3.25	4.0	11	1.9	2.3	0.0043	16	44
1.5	1.75			M3AAN100 L	3GAA 103 001-••A	950	80.0	77.0	0.71	3.92	4.5	15	1.9	2.3	0.0082	23	49
2.2	2.5			M3AA 112 M	3GAA 113 001-••C	940	80.5	80.5	0.74	5.4	5.6	22	2.1	2.7	0.015	27	54
3	3.5			M3AA 132 S	3GAA 133 001-••C	960	84.5	84.5	0.75	6.9	6.1	30	2.4	2.6	0.031	39	61
4	4.6			M3AA 132 MA	3GAA 133 002-••C	960	85.5	85.5	0.78	8.7	7.1	40	2.6	2.8	0.038	46	61
5.5	6.4			M3AA 132 MB	3GAA 133 003-••C	955	86.0	86.0	0.78	11.9	6.9	55	2.8	2.8	0.045	54	61
7.5	8.6			M3AA 160 M	3GAA 163 101-••C	970	89.3	89.3	0.79	15.4	6.7	74	2.0	2.8	0.089	88	59
11	12.5			M3AA 160 L	3GAA 163 102-••C	970	89.8	89.8	0.78	23	7.1	109	2.2	2.9	0.107	102	59
15	17			M3AA 180 L	3GAA 183 101-••C	970	90.8	90.8	0.78	31	7.0	148	2.1	3.0	0.217	151	59
18.5	21			M3AA 200 MLA	3GAA 203 001-••C	985	91.1	91.1	0.81	36	7.0	179	2.5	2.7	0.37	165	63
22	25			M3AA 200 MLB	3GAA 203 002-••C	980	91.7	91.7	0.81	43	7.2	214	2.5	2.7	0.43	185	63
30	34			M3AA 225 SMB	3GAA 223 001-••C	985	92.8	92.8	0.83	56	6.6	291	2.5	2.7	0.64	225	63
37	42			M3AA 250 SMA	3GAA 253 001-••C	985	93.7	93.7	0.83	69	7.3	359	2.8	2.8	1.16	280	63
				1000 r/min = 6 poles				400 V 50 Hz				High-output design					
1.3	1.5	¹⁾		M3AAN90 LB	3GAA 093 003-••A	910	69.0	69.0	0.71	3.85	4.0	13.5	1.9	2.2	0.0048	18	44
2.2	2.5	¹⁾		M3AAN100 LC	3GAA 103 002-••A	940	77.0	72.8	0.71	5.9	4.5	22	1.9	2.3	0.009	26	49
3	3.5	¹⁾		M3AA 112 MB	3GAA 113 002-••C	935	80.0	80.0	0.76	7.2	5.5	31	2.4	2.7	0.018	33	54
6.5	7.5	¹⁾		M3AA 132 MC	3GAA 133 004-••C	960	85.0	85.0	0.75	14.8	6.6	65	2.3	2.7	0.049	59	61
14	16.1	¹⁾		M3AA 160 LB	3GAA 163 103-••C	960	89.1	89.1	0.77	29.5	7.6	139	2.7	3.1	0.127	117	62
18.5	20	¹⁾		M3AA 180 LB	3GAA 183 102-••C	965	90.6	90.6	0.79	37.5	6.2	183	2.0	2.6	0.237	160	59
30	34	¹⁾		M3AA 200 MLC	3GAA 203 003-••C	980	91.7	91.7	0.81	56	7.5	292	3.3	3.0	0.49	200	63
37	42	¹⁾		M3AA 225 SMC	3GAA 223 002-••C	985	93.2	93.2	0.83	69	7.7	359	3.1	3.0	0.75	252	63
45	52	¹⁾		M3AA 250 SMB	3GAA 253 002-••C	985	94.1	94.1	0.84	82	7.3	436	2.8	2.8	1.49	320	63

¹⁾ Temperature rise acc. to class F.

Note: When placing orders for frame sizes 90-100, the variant code +094 should be added.

Data for other voltages on request.

During the transition period some motor types belonging to M3000 range still have the old product codes and type designations. Always check the valid code before ordering.

Technical data – Non-sparking motors

Aluminium frame, sizes 90 to 250



IP 55, IC 411; Insulation class F, temperature rise class B

Output				Efficiency		Power factor	Current		Torque			Moment of inertia J=1/4 GD ² kgm ²	Weight kg	Sound pressure level LP dB(A)	
400V 50Hz	440V 60Hz	Type designation	Product code	Speed r/min	Full load 100%		3/4 load 75%	I _N A	I _s A	T _N Nm	T _s Nm				T _{max} Nm
750 r/min = 8 poles															
400 V 50 Hz															
Basic design															
0.37	0.45	M3AAN 90 S	3GAA 094 001-••A	700	61.5	43.4	0.56	1.6	3.0	5	1.9	2.4	0.0032	13	43
0.55	0.65	M3AAN 90 L	3GAA 094 002-••A	690	62.9	56.4	0.57	2.35	3.0	7.5	1.7	2.1	0.0043	16	43
0.75	0.9	M3AAN 100 LA	3GAA 104 001-••A	700	72.0	63.6	0.59	2.55	3.5	10	2.1	2.7	0.0069	20	46
1.1	1.3	M3AAN 100 LB	3GAA 104 002-••A	700	73.0	68.8	0.64	3.35	3.5	15	2.1	2.7	0.0082	23	46
1.5	1.7	M3AA 112 M	3GAA 114 001-••C	695	74.5	74.5	0.65	4.5	4.1	21	1.9	2.4	0.016	28	52
2.2	2.5	M3AA 132 S	3GAA 134 001-••C	720	80.5	80.5	0.67	5.9	5.3	29	1.9	2.5	0.038	46	56
3	3.5	M3AA 132 M	3GAA 134 002-••C	720	82.0	82.1	0.68	7.8	5.5	40	2.4	2.6	0.045	53	56
4	4.6	M3AA 160 MA	3GAA 164 101-••C	715	84.1	84.7	0.69	10	5.2	54	2.1	2.4	0.072	75	59
5.5	6.4	M3AA 160 M	3GAA 164 102-••C	710	84.7	85.5	0.70	13.4	5.4	74	2.4	2.6	0.091	88	59
7.5	8.6	M3AA 160 L	3GAA 164 103-••C	715	86.3	87.2	0.70	18.1	5.4	100	2.4	2.8	0.131	118	59
11	13	M3AA 180 L	3GAA 184 101-••C	720	88.7	89.2	0.76	23.5	5.9	146	2.4	2.6	0.224	147	59
15	17	M3AA 200 MLA	3GAA 204 001-••C	740	91.1	91.1	0.82	29	7.4	194	1.8	3.0	0.45	175	60
18.5	21	M3AA 225 SMA	3GAA 224 001-••C	730	91.1	91.1	0.79	37	6.2	242	1.9	2.7	0.61	210	63
22	25	M3AA 225 SMB	3GAA 224 002-••C	730	91.5	91.5	0.77	45	6.0	288	1.9	2.7	0.68	225	63
30	34	M3AA 250 SMA	3GAA 254 001-••C	735	92.8	92.8	0.79	59	6.9	390	1.9	2.9	1.25	280	63
750 r/min = 8 poles															
400 V 50 Hz															
High-output design															
0.75	0.9	¹⁾ M3AAN 90 LB	3GAA 094 003-••A	680	64.0	60.0	0.65	2.65	3.0	10	1.8	2.0	0.0048	18	43
1.5	1.75	¹⁾ M3AAN 100 LC	3GAA 104 003-••A	685	71.0	65.9	0.66	4.7	3.5	21	1.8	2.2	0.009	26	46
2	2.3	¹⁾ M3AA 112 MB	3GAA 114 002-••C	685	73.5	74.6	0.67	5.9	4.4	28	1.9	2.2	0.018	33	52
3.8	4.4	¹⁾ M3AA 132 MB	3GAA 134 003-••C	710	80.5	80.7	0.69	9.9	5.2	51	2.0	2.3	0.049	59	56
8.5	9.8	¹⁾ M3AA 160 LB	3GAA 164 104-••C	700	83.5	85.0	0.70	21	5.1	115	2.4	2.5	0.131	118	62
15	16	¹⁾ M3AA 180 LB	3GAA 184 102-••C	720	88.0	89.2	0.76	32.5	6.0	199	2.5	2.6	0.24	155	62
18.5	21	M3AA 200 ML	3GAA 204 002-••C	745	91.4	91.4	0.81	36	6.7	237	1.7	2.8	0.54	200	60
30	34	¹⁾ M3AA 225 SMC	3GAA 224 003-••C	735	91.8	91.8	0.79	60	7.2	390	2.1	3.3	0.8	255	63
37	42	M3AA 250 SMB	3GAA 254 002-••C	735	93.2	93.2	0.81	71	7.2	481	2.0	2.9	1.52	320	63

¹⁾ Temperature rise acc. to class F.

Note: When placing orders for frame sizes 90-100, the variant code +094 should be added.

Data for other voltages on request.

During the transition period some motor types belonging to M3000 range still have the old product codes and type designations. Always check the valid code before ordering.

The two bullets in the product code indicate choice of mounting arrangement (see ordering information), voltage and frequency (below).

Motor size	S		D		H	E	F	T	U	X
	50 Hz	60 Hz	50 Hz	60 Hz						
90-100	220-230 VΔ		380-400 VΔ	440-460 VΔ	–	500 VΔ	500 VY	–	–	Other rated voltage, connection or frequency, 690 V maximum (500 V maximum for frame sizes 90-100)
	380-400 VY	440-460 VY	660-690 VY	–						
112-132	220-240 VΔ	–	380-420 VΔ	440-480 VΔ	415 VΔ	500 VΔ	–	660 VΔ	690 VΔ	
	380-420 VY	440-480 VY	660-690 VY	–						
160-250	220,230 VΔ	–	380,400,415 VΔ	440 VΔ	415 VΔ	500 VΔ	–	660 VΔ	690 VΔ	
	380,400,415 VY	440 VY	660-690 VY	–						

Technical data – Non-sparking motors

Cast iron frame, sizes 71 to 400



IP 55, IC 411; Insulation class F, temperature rise class B

Output			Efficiency									Moment of inertia		Sound	
kW	Type	Product	Speed	Full load	3/4 load	Power factor	Current		Torque			J=1/4 GD ²	Weight	pressure level LP	
400V 440V 50Hz 60Hz	designation	code	r/min	100%	75%	cos φ	I _N	I _s I _N	T _N	T _s	T _{max}	kgm ²	kg	dB(A)	
3000 r/min = 2 poles			400 V 50 Hz ¹⁾						Basic design						
0.37 0.44	M2BA 71 M2 A	3GBA 071 310-••A	2810	69.0	³⁾	0.80	1	5.2	1.3	2.3	2.4	0.0003	10	56	
0.55 0.66	M2BA 71 M2 B	3GBA 071 320-••A	2800	71.9	³⁾	0.82	1.3	5.2	1.3	2.3	2.4	0.0004	11	56	
0.75 0.86	M2BA 80 M2 A	3GBA 081 310-••A	2850	75.7	³⁾	0.86	1.6	6.3	2.5	2.4	2.7	0.0009	16	57	
1.1 1.27	M2BA 80 M2 B	3GBA 081 320-••A	2850	77.5	³⁾	0.85	2.3	6.4	3.7	2.6	2.8	0.0011	17	58	
1.5 1.73	M2BA 90 S2 A	3GBA 091 110-••A	2850	78.4	³⁾	0.85	3.2	6.1	5	2.4	2.3	0.0014	21	61	
2.2 2.53	M2BA 90 L2 A	3GBA 091 510-••A	2850	81.9	³⁾	0.84	4.5	7.5	7.4	2.8	3.0	0.0016	24	61	
3 3.45	M2BA 100 L2 A	3GBA 101 510-••A	2870	83.0	³⁾	0.86	5.9	6.9	10	2.8	3.4	0.004	33	65	
4 4.6	M2BA 112 M2 A	3GBA 111 310-••A	2900	84.6	³⁾	0.89	7.5	7.3	13	2.4	3.0	0.0067	42	67	
5.5 6.33	M2BA 132 S2 A	3GBA 131 110-••A	2920	88.0	³⁾	0.88	10.1	7.6	18	2.1	3.2	0.0124	58	70	
7.5 8.6	M2BA 132 S2 B	3GBA 131 120-••A	2920	89.4	³⁾	0.89	13.5	7.5	24.5	2.5	3.3	0.0149	63	70	
11 12.5	M3GP 160 MLA	3GGP 161 410-••G	2936	91.2	91.1	0.87	20	7.2	36	2.9	3.3	0.039	147	71	
15 17	M3GP 160 MLB	3GGP 161 420-••G	2934	91.6	91.5	0.88	28	7.5	49	3.1	3.5	0.047	156	71	
18.5 21	M3GP 160 MLC	3GGP 161 430-••G	2934	92.4	92.5	0.90	33	7.5	60	2.8	3.4	0.054	167	71	
22 25	M3GP 180 MLA	3GGP 181 410-••G	2938	92.6	92.7	0.90	39	6.9	72	2.5	3.1	0.077	194	71	
30 35	M3GP 200 MLA	3GGP 201 410-••G	2946	94.0	94.1	0.88	54	7.4	97	3.0	3.2	0.15	275	74	
37 43	M3GP 200 MLC	3GGP 201 430-••G	2948	94.1	94.0	0.89	65	7.6	120	2.9	3.2	0.19	305	77	
45 52	M3GP 225 SMB	3GGP 221 220-••G	2968	94.7	94.6	0.87	79	7.2	145	2.7	3.0	0.26	365	76	
55 63	M3GP 225 SMA	3GGP 251 210-••G	2970	94.6	94.3	0.88	96	7.7	177	2.4	3.1	0.49	425	75	
75 90	M3GP 280 SMA	3GGP 281 210-••G	2978	94.8	94.3	0.88	131	7.6	240	2.1	3.0	0.8	625	77	
90 105	M3GP 280 SMB	3GGP 281 220-••G	2976	95.1	94.8	0.90	152	7.4	289	2.1	2.9	0.9	665	77	
110 125	M3GP 315 SMA	3GGP 311 210-••G	2982	95.1	94.4	0.86	194	7.6	352	2.0	3.0	1.2	880	78	
132 155	M3GP 315 SMB	3GGP 311 220-••G	2982	95.4	94.9	0.88	228	7.4	423	2.2	3.0	1.4	940	78	
160 185	M3GP 315 SMC	3GGP 311 230-••G	2981	96.1	95.6	0.89	269	7.5	513	2.3	3.0	1.7	1025	78	
200 230	M3GP 315 MLA	3GGP 311 410-••G	2980	96.3	95.9	0.90	336	7.7	641	2.6	3.0	2.1	1190	78	
250 285	M2BA 355 S	3GBA 351 100-••A	2980	96.1	95.7	0.92	410	6.6	801	1.3	3.0	3.8	1550	83	
315 360	M2BA 355 SMA	3GBA 351 210-••A	2978	96.6	96.4	0.92	510	7.7	1010	1.3	3.3	4.8	1750	83	
400 450	M2BA 355 MLA	3GBA 351 410-••A	2982	96.6	96.4	0.92	655	7.7	1281	1.6	3.3	6	2150	83	
430 500	M2BA 355 MLC	3GBA 351 430-••A	2978	96.6	96.4	0.92	700	7.8	1379	1.3	3.3	6	2150	83	
400 450	M2BA 400 M	3GBA 401 300-••A	2982	96.6	96.4	0.92	655	7.7	1281	1.6	3.3	6	2200	83	
430 500	M2BA 400 MA	3GBA 401 310-••A	2978	96.6	96.4	0.92	700	7.8	1379	1.3	3.3	6	2200	83	
470 ³⁾ ²⁾	M2BA 400 LKA	3GBA 401 510-••A	2981	96.6	96.5	0.93	750	7.4	1506	0.9	3.0	7.5	2850	85	
560 ³⁾ ²⁾	M2BA 400 LKB	3GBA 401 520-••A	2983	96.7	96.5	0.92	910	7.3	1793	0.7	3.4	8.5	2900	85	
3000 r/min = 2 poles			400 V 50 Hz ¹⁾						High-output design						
22 25	M3GP 160 MLD	3GGP 161 440-••G	2929	91.4	91.3	0.90	39	7.4	72	2.8	3.4	0.059	173	77	
30 34	M3GP 180 MLB	3GGP 181 420-••G	2944	92.8	92.7	0.88	54	7.5	97	2.8	3.5	0.092	210	78	
55 63	M3GP 225 SMC	3GGP 221 230-••G	2965	94.3	94.0	0.88	96	7.1	177	2.6	3.0	0.29	385	80	
75 86	M3GP 250 SMB	3GGP 251 220-••G	2969	95.1	95.0	0.89	129	7.9	241	2.6	3.2	0.57	465	80	
110 125	M3GP 280 SMC	3GGP 281 230-••G	2978	95.7	95.3	0.90	185	7.9	353	2.4	3.0	1.15	725	77	

¹⁾ Motors are certified for the voltages 380-400-415 V 50 Hz according to IEC 60034-1. ²⁾ Temperature rise class F.
Values above are given for 400 V 50 Hz; data for other voltages on request. ³⁾ On request.

ATEX certification process ongoing for frame sizes 355-400.

Please note that the frequency converter application in critical conditions may require special rotor design within 355 to 400 frame motors. We therefore recommend a separate checking.

Notes:

- When ordering sizes 160-200 with lifetime lubrication, variant code 194 'ZZ-bearings at both ends' has to be added.

Data for other voltages and frequencies, on request.
2- and 4-pole Cenelec motors size 160-250 can be used at ambient 50°C in temperature rise max. 75 K (cl. F); for more information contact us.

The two bullets in the product code indicate choice of mounting arrangement (see ordering information), voltage and frequency (below).

S	D	A ^{a)}	B ^{a)}	E	F ^{b)}	X
380 VY 50 Hz	380 VΔ 50 Hz	380 VY 50 Hz	380 VΔ 50 Hz	500 VΔ 50 Hz	500 VY 50 Hz	Other rated voltage, connection or frequency, max. 690 V
400 VY 50 Hz	400 VΔ 50 Hz	220 VΔ 50 Hz	660 VY 50 Hz	575 VΔ 60 Hz		
415 VY 50 Hz	415 VΔ 50 Hz					
220 VΔ 50 Hz	660 VY 50 Hz	G ^{a)}	H ^{a)}	T ^{b)}	U ^{b)c)}	
230 VΔ 50 Hz	690 VY 50 Hz ^{c)}	415 VY 50 Hz	415 VΔ 50 Hz	660 VΔ 50 Hz	690 VΔ 50 Hz	
440 VΔ 60 Hz	440 VΔ 60 Hz					

^{a)} On request for motor sizes 315-400.

^{b)} On request for motor sizes 355-400.

^{c)} Motor sizes 80-250: Not permitted for Ex N acc. to BS 5000:16. Motor sizes 280-400 available on VTT certificate.

Technical data – Non-sparking motors

Cast iron frame, sizes 71 to 400



IP 55, IC 411; Insulation class F, temperature rise class B

Output				Efficiency				Power factor	Current			Torque			Moment of inertia		Sound pressure level LP
400V	440V	Type	Product	Speed	Full load	3/4 load	cos φ		I _N	I _s	I _N	T _N	T _s	T _{max}	J=1/4 GD ²	Weight	
50Hz	60Hz	designation	code	r/min	100%	75%		A	I _s	I _N	Nm	T _N	T _N	T _N	kgm ²	kg	dB(A)
1500 r/min = 4 poles				400 V 50 Hz ¹⁾				Basic design									
0.25	0.28	M2BA 71 M4 A	3GBA 072 310-**A	1390	65.3	4)	0.80	0.8	4.3	1.7	2.0	2.3	0.0005	11	43		
0.37	0.41	M2BA 71 M4 B	3GBA 072 320-**A	1380	69.3	4)	0.75	1	4.4	2.6	2.1	2.3	0.0007	11	45		
0.55	0.66	M2BA 80 M4 A	3GBA 082 310-**A	1410	75.3	4)	0.73	1.5	5.3	3.7	2.5	2.6	0.0014	16	46		
0.75	0.9	M2BA 80 M4 B	3GBA 082 320-**A	1410	74.2	4)	0.71	2	5.2	5	2.5	2.6	0.0017	17	46		
1.1	1.3	M2BA 90 S4 A	3GBA 092 110-**A	1400	77.0	4)	0.78	2.6	5.4	7.5	2.2	2.3	0.0025	21	52		
1.5	1.8	M2BA 90 L4 A	3GBA 092 510-**A	1410	79.0	4)	0.78	3.5	5.5	10	2.9	3.0	0.0037	26	52		
2.2	2.6	M2BA 100 L4 A	3GBA 102 510-**A	1430	81.8	4)	0.80	4.8	6.3	14.7	2.5	3.0	0.0068	32	53		
3	3.6	M2BA 100 L4 B	3GBA 102 520-**A	1420	82.7	4)	0.82	6.25	6.6	20	2.9	3.4	0.0086	36	53		
4	4.8	M2BA 112 M4 A	3GBA 112 310-**A	1430	84.7	4)	0.81	8.2	6.7	27	2.3	2.8	0.0131	45	56		
5.5	6.6	M2BA 132 S4 A	3GBA 132 110-**A	1430	86.9	4)	0.84	10.8	6.5	36.7	2.4	3.0	0.0267	60	59		
7.5	9	M2BA 132 M4 A	3GBA 132 310-**A	1430	88.5	4)	0.85	14.2	6.8	50	2.6	3.0	0.0343	73	59		
11	12.5	M3GP 160 MLC	3GGP 162 430-**G	1470	91.3	91.3	0.82	22.5	7.7	71	3.1	3.6	0.09	166	62		
15	17	M3GP 160 MLE	3GGP 162 450-**G	1467	92.0	92.0	0.83	30	7.6	98	3.1	3.6	0.121	189	67		
18.5	21	M3GP 180 MLA	3GGP 182 410-**G	1474	92.5	92.6	0.82	36	7.3	120	2.7	3.2	0.176	206	62		
22	25	M3GP 180 MLB	3GGP 182 420-**G	1471	92.6	92.7	0.82	42	7.1	143	2.6	3.0	0.191	214	62		
30	35	M3GP 200 MLB	3GGP 202 420-**G	1475	93.5	93.6	0.84	56	7.4	194	3.3	3.0	0.34	305	61		
37	42	M3GP 225 SMB	3GGP 222 220-**G	1480	93.6	93.4	0.84	69	7.7	239	3.1	3.1	0.42	355	67		
45	52	M3GP 225 SMC	3GGP 222 230-**G	1477	94.4	94.4	0.86	81	7.4	291	3.1	3.0	0.49	390	67		
55	63	M3GP 250 SMA	3GGP 252 210-**G	1479	94.6	94.7	0.83	101	6.9	355	2.5	3.1	0.72	415	66		
75	88	M3GP 280 SMA	3GGP 282 210-**G	1484	94.9	94.8	0.85	135	6.9	483	2.5	2.8	1.25	625	68		
90	105	M3GP 280 SMB	3GGP 282 220-**G	1483	95.2	95.2	0.86	159	7.2	580	2.5	2.7	1.5	665	68		
110	125	M3GP 315 SMA	3GGP 312 210-**G	1487	95.6	95.4	0.86	193	7.2	706	2.0	2.5	2.3	900	70		
132	150	M3GP 315 SMB	3GGP 312 220-**G	1487	95.8	95.6	0.86	232	7.1	848	2.3	2.7	2.6	960	70		
160	185	M3GP 315 SMC	3GGP 312 230-**G	1487	96.0	95.9	0.85	287	7.2	1028	2.4	2.9	2.9	1000	70		
200	230	M3GP 315 MLA	3GGP 312 410-**G	1486	96.2	96.2	0.86	351	7.2	1285	2.5	2.9	3.5	1160	74		
250	285	M2BA 355 S	3GBA 352 100-**A	1487	96.5	96.4	0.87	430	7.2	1606	2.3	2.7	6.5	1550	80		
315	360	M2BA 355 SMA	3GBA 352 210-**A	1488	96.7	96.6	0.87	545	7.6	2022	2.5	2.9	8.2	1800	80		
355	400	M2BA 355 SMB	3GBA 352 220-**A	1486	96.7	96.7	0.87	610	6.8	2281	2.2	2.6	8.2	1800	80		
400	450	M2BA 355 MLA	3GBA 352 410-**A	1489	96.8	96.8	0.87	685	6.9	2565	1.6	2.8	10	2100	80		
450	500 ²⁾	M2BA 355 MLB	3GBA 352 420-**A	1489	96.8	96.8	0.87	770	7.6	2886	1.5	3.0	10	2100	80		
500	560	M2BA 355 MLC	3GBA 352 430-**A	1489	96.8	96.8	0.88	845	7.6	3207	1.3	2.9	10.5	2100	83		
400	450	M2BA 400 M	3GBA 402 300-**A	1489	96.8	96.8	0.87	685	6.9	2565	1.6	2.8	10	2150	80		
450	500 ²⁾	M2BA 400 MA	3GBA 402 310-**A	1489	96.8	96.8	0.87	770	7.6	2886	1.5	3.0	10	2150	80		
500	560	M2BA 400 MB	3GBA 402 320-**A	1489	96.8	96.8	0.88	845	7.6	3207	1.3	2.9	10.5	2150	83		
560	630	M2BA 400 LKA	3GBA 402 510-**A	1489	96.9	96.9	0.90	925	6.6	3591	1.1	2.6	14	3050	85		
630	710	M2BA 400 LKB	3GBA 402 520-**A	1489	96.9	96.8	0.87	1080	6.9	4040	1.2	2.8	15	3150	85		

1500 r/min = 4 poles				400 V 50 Hz ¹⁾				High-output design									
18.5	21	M3GP 160 MLF	3GGP 162 460-**G	1466	92.0	92.0	0.82	36.5	8.0	120	3.2	3.6	0.121	189	68		
30	34 ²⁾	M3GP 180 MLC	3GGP 182 430-**G	1473	92.3	92.3	0.80	59	7.8	194	3.1	3.4	0.239	233	66		
37	42	M3GP 200 MLC	3GGP 202 430-**G	1475	93.3	93.3	0.82	70	7.5	239	3.5	3.2	0.34	305	73		
55	61 ³⁾	M3GP 225 SMD	3GGP 222 240-**G	1476	94.0	93.9	0.85	100	7.6	356	3.3	3.1	0.49	390	74		
75	82 ³⁾	M3GP 250 SMB	3GGP 252 220-**G	1476	94.7	94.9	0.86	133	7.2	485	2.7	3.2	0.88	470	73		
110	125	M3GP 280 SMC	3GGP 282 230-**G	1485	95.6	95.5	0.86	195	7.6	707	3.0	3.0	1.85	725	68		

¹⁾ Motors are certified for the voltages 380-400-415 V 50 Hz according to IEC 60034-1.

Values above are given for 400 V 50 Hz; data for other voltages on request.

³⁾ for 400-415 V 50 Hz (380 V 50 Hz voltage code B or A)

²⁾ Temperature rise class F.

⁴⁾ On request.

ATEX certification process ongoing for frame sizes 355-400.

Please note that the frequency converter application in critical conditions may require special rotor design within 355 to 400 frame motors. We therefore recommend a separate checking.

Notes:

- When ordering sizes 160-200 with lifetime lubrication, variant code 194 '2Z-bearings at both ends' has to be added.

Data for other voltages and frequencies, on request.

2- and 4-pole Cenelec motors size 160-250 can be used at ambient 50°C in temperature rise max. 75 K (cl. F); for more information contact us.

The two bullets in the product code indicate choice of mounting arrangement (see ordering information), voltage and frequency (below).

S	D	A ^{a)}	B ^{a)}	E	F ^{b)}	X
380 VΔ 50 Hz	380 VΔ 50 Hz	380 VY 50 Hz	380 VΔ 50 Hz	500 VΔ 50 Hz	500 VY 50 Hz	Other rated voltage, connection or frequency, max. 690 V
400 VY 50 Hz	400 VΔ 50 Hz	220 VΔ 50 Hz	660 VY 50 Hz	575 VΔ 60 Hz		
415 VY 50 Hz	415 VΔ 50 Hz					
220 VΔ 50 Hz	660 VY 50 Hz	G ^{a)}	H ^{a)}	T ^{b)}	U ^{b)c)}	
230 VΔ 50 Hz	690 VY 50 Hz ^{d)}	415 VY 50 Hz	415 VΔ 50 Hz	660 VΔ 50 Hz	690 VΔ 50 Hz	
440 VΔ 60 Hz	440 VΔ 60 Hz					

^{a)} On request for motor sizes 315-400.

^{b)} On request for motor sizes 355-400.

^{d)} Motor sizes 80-250: Not permitted for Ex N acc. to BS 5000:16. Motor sizes 280-400 available on VTT certificate.

Technical data – Non-sparking motors

Cast iron frame, sizes 71 to 400



IP 55, IC 411; Insulation class F, temperature rise class B

Output kW 400V 440V 50Hz 60Hz	Type designation	Product code	Efficiency			Speed r/min	Power factor cos φ	Current		Torque			Moment of inertia J=1/4 GD ²		Sound pressure level LP dB(A)
			Full load 100%	3/4 load 75%	I _N A			I _s I _N	T _N Nm	T _s T _N	T _{max} T _N	kgm ²	Weight kg		
														Weight kg	
1000 r/min = 6 poles			400 V 50 Hz ¹⁾				Basic design								
0.18 0.21	M2BA 71 M6 A	3GBA 073 310-••A	880	55.6 ⁴⁾	0.65	0.75	2.9	2	1.9	2.0	0.0006	10	42		
0.25 0.3	M2BA 71 M6 B	3GBA 073 320-••A	880	60.7 ⁴⁾	0.65	0.9	3.2	2.8	2.2	2.4	0.0007	11	42		
0.37 0.44	M2BA 80 M6 A	3GBA 083 310-••A	920	64.3 ⁴⁾	0.65	1.2	3.5	3.8	1.7	2.2	0.0016	17	45		
0.55 0.66	M2BA 80 M6 B	3GBA 083 320-••A	920	66.1 ⁴⁾	0.66	1.7	3.5	5.7	1.7	2.2	0.002	18	45		
0.75 0.9	M2BA 90 S6 A	3GBA 093 110-••A	920	70.2 ⁴⁾	0.71	2	4.1	7.7	2.1	2.5	0.0029	21	48		
1.1 1.3	M2BA 90 L6 A	3GBA 093 510-••A	920	73.0 ⁴⁾	0.73	2.9	4.3	11.5	2.0	2.3	0.0038	25	48		
1.5 1.8	M2BA 100 L6 A	3GBA 103 510-••A	930	75.4 ⁴⁾	0.73	3.8	4.7	15	2.3	2.7	0.01	32	51		
2.2 2.6	M2BA 112 M6 A	3GBA 113 310-••A	940	79.8 ⁴⁾	0.73	5.2	4.9	22	2.2	2.7	0.0156	40	54		
3 3.6	M2BA 132 S6 A	3GBA 133 110-••A	960	82.4 ⁴⁾	0.77	6.7	5.8	30	2.2	2.8	0.0312	55	56		
4 4.8	M2BA 132 M6 A	3GBA 133 310-••A	960	83.9 ⁴⁾	0.76	8.9	6.1	40	2.4	3.0	0.0407	65	56		
5.5 6.6	M2BA 132 M6 B	3GBA 133 320-••A	950	85.8 ⁴⁾	0.78	11.7	6.5	55	2.4	3.1	0.0533	75	56		
7.5 8.6	M3GP 160 MLA	3GGP 163 410-••G	965	88.6 89.3	0.80	15.5	6.5	74	1.9	3.0	0.088	160	57		
11 12.5	M3GP 160 MLB	3GGP 163 420-••G	965	89.2 89.9	0.79	23	7.1	109	2.1	3.3	0.106	173	65		
15 17	M3GP 180 MLB	3GGP 183 420-••G	972	91.1 91.3	0.80	31	7.0	147	1.9	3.3	0.221	233	67		
18.5 21	M3GP 200 MLA	3GGP 203 410-••G	983	91.3 91.4	0.80	37	7.1	180	3.2	3.1	0.37	265	66		
22 25	M3GP 200 MLB	3GGP 203 420-••G	983	91.6 91.6	0.81	43	7.5	214	3.2	3.2	0.43	285	61		
30 34	M3GP 225 SMB	3GGP 223 220-••G	985	92.8 92.8	0.81	58	7.4	291	3.4	3.0	0.64	350	61		
37 42	M3GP 250 SMA	3GGP 253 210-••G	987	93.4 93.4	0.81	71	7.2	358	3.2	2.9	1.16	420	66		
45 55	M3GP 280 SMA	3GGP 283 210-••G	990	94.4 94.3	0.84	82	7.0	434	2.5	2.5	1.85	605	66		
55 63	M3GP 280 SMB	3GGP 283 220-••G	990	94.6 94.6	0.84	101	7.0	531	2.7	2.6	2.2	645	66		
75 86	M3GP 315 SMA	3GGP 313 210-••G	992	95.0 94.7	0.82	141	7.4	722	2.4	2.8	3.2	830	70		
90 105	M3GP 315 SMB	3GGP 313 220-••G	992	95.5 95.3	0.84	163	7.5	866	2.4	2.8	4.1	930	70		
110 125	M3GP 315 SMC	3GGP 313 230-••G	991	95.6 95.5	0.83	202	7.4	1060	2.5	2.9	4.9	1000	70		
132 150	M3GP 315 MLA	3GGP 313 410-••G	991	95.8 95.7	0.83	240	7.5	1272	2.7	3.0	5.8	1150	68		
160 195	M2BA 355 S	3GBA 353 100-••A	992	95.9 95.7	0.85	280	6.8	1540	1.8	2.7	10.4	1550	75		
200 230	M2BA 355 SMA	3GBA 353 210-••A	992	95.9 95.7	0.85	355	7.1	1925	2.0	2.7	12.5	1800	75		
250 300	M2BA 355 SMB	3GBA 353 220-••A	992	96.0 95.8	0.84	450	7.5	2407	2.2	2.8	12.5	1800	75		
315 360	M2BA 355 MLA	3GBA 353 410-••A	991	96.2 96.1	0.84	565	7.3	3036	2.0	3.0	14.6	2100	75		
355 400	M2BA 355 MLC	3GBA 353 430-••A	991	96.4 96.3	0.84	635	7.6	3421	1.5	3.0	15.8	2100	78		
250 300	M2BA 400 M	3GBA 403 300-••A	992	96.0 95.8	0.84	450	7.5	2407	2.2	2.8	12.5	2000	75		
315 360	M2BA 400 MA	3GBA 403 310-••A	991	96.2 96.1	0.84	565	7.3	3036	2.0	3.0	14.6	2150	75		
355 400	M2BA 400 MB	3GBA 403 320-••A	991	96.4 96.3	0.84	635	7.6	3421	1.5	3.0	15.8	2150	78		
400 450	M2BA 400 LKA	3GBA 403 510-••A	992	96.5 96.4	0.85	700	6.4	3851	1.2	2.7	16.5	2800	80		
450 510	M2BA 400 LKB	3GBA 403 520-••A	993	96.5 96.4	0.85	790	6.8	4328	1.3	2.8	19	3050	80		
500 560 ²⁾	M2BA 400 LKC	3GBA 403 530-••A	992	96.5 96.4	0.85	880	6.8	4813	1.3	2.8	19	3050	80		
1000 r/min = 6 poles			400 V 50 Hz ¹⁾				High-output design								
14 16.1 ²⁾³⁾	M3GP 160 MLC	3GGP 163 430-••G	969	88.9 88.9	0.74	31	7.9	138	2.8	3.9	0.121	188	64		
30 34	M3GP 200 MLC	3GGP 203 430-••G	983	91.6 91.5	0.80	60	7.5	292	3.5	3.4	0.49	305	65		
37 42	M3GP 225 SMC	3GGP 223 230-••G	983	92.8 92.9	0.83	70	7.1	359	3.2	2.8	0.75	380	64		
45 52	M3GP 250 SMB	3GGP 253 220-••G	986	93.7 93.7	0.82	85	7.2	436	3.3	2.8	1.49	465	65		
75 86	M3GP 280 SMC	3GGP 283 230-••G	990	95.1 95.2	0.84	137	7.3	723	2.8	2.7	2.85	725	66		

¹⁾ Motors are certified for the voltages 380-400-415 V 50 Hz according to IEC 60034-1. Values above are given for 400 V 50 Hz; data for other voltages on request.

²⁾ Temperature rise class F

³⁾ Nominal power lower than CENELEC +1..

⁴⁾ On request.

ATEX certification process ongoing for frame sizes 355-400.

Please note that the frequency converter application in critical conditions may require special rotor design within 355 to 400 frame motors. We therefore recommend a separate checking.

Notes:

- When ordering sizes 160-200 with lifetime lubrication, variant code 194 '2Z-bearings at both ends' has to be added.

Data for other voltages and frequencies, on request.

2- and 4-pole Cenelec motors size 160-250 can be used at ambient 50°C in temperature rise max. 75 K (cl. F); for more information contact us.

Technical data – Non-sparking motors

Cast iron frame, sizes 160 to 400



IP 55, IC 411; Insulation class F, temperature rise class B

Output				Efficiency			Power factor	Current		Torque			Moment of inertia		Sound pressure level LP
kW	400V 440V 50Hz 60Hz	Type designation	Product code	Speed r/min	Full load 100%	3/4 load 75%		I_N A	I_s A	T_N Nm	T_s Nm	T_{max} Nm	$J=1/4 GD^2$ kgm ²	Weight kg	

750 r/min = 8 poles				400 V 50 Hz ¹⁾				Basic design							
4	4.6	M3GP 160 MLA	3GGP 164 410-••G	717	83.0	83.1	0.70	10.1	5.2	53	1.8	2.8	0.071	146	59
5.5	6.4	M3GP 160 MLB	3GGP 164 420-••G	715	84.1	84.6	0.70	13.9	5.2	73	1.9	2.8	0.09	160	53
7.5	8.6	M3GP 160 MLC	3GGP 164 430-••G	718	86.4	87.1	0.69	18.4	5.7	100	2.1	3.1	0.121	188	55
11	13	M3GP 180 MLB	3GGP 184 420-••G	724	89.9	90.0	0.72	24.5	5.7	145	1.7	2.7	0.239	227	63
15	17	M3GP 200 MLA	3GGP 204 410-••G	734	90.4	90.5	0.78	31	7.0	195	2.4	3.2	0.45	280	56
18.5	21	M3GP 225 SMA	3GGP 224 210-••G	734	90.5	90.5	0.73	41	6.1	241	2.2	3.0	0.61	335	55
22	25	M3GP 225 SMB	3GGP 224 220-••G	732	90.7	91.0	0.76	46	6.5	287	2.2	2.9	0.68	350	56
30	34	M3GP 250 SMA	3GGP 254 210-••G	735	92.0	92.1	0.78	61	6.7	390	2.0	2.9	1.25	420	56
37	43	M3GP 280 SMA	3GGP 284 210-••G	741	93.4	93.3	0.78	74	7.3	477	1.7	3.0	1.85	605	65
45	55	M3GP 280 SMB	3GGP 284 220-••G	741	94.0	93.8	0.78	90	7.6	580	1.8	3.1	2.2	645	65
55	63	M3GP 315 SMA	3GGP 314 210-••G	742	94.1	94.0	0.81	104	7.1	708	1.6	2.7	3.2	830	62
75	85	M3GP 315 SMB	3GGP 314 220-••G	741	94.4	94.3	0.82	141	7.1	968	1.7	2.7	4.1	930	62
90	105	M3GP 315 SMC	3GGP 314 230-••G	741	94.8	94.7	0.82	167	7.4	1161	1.8	2.7	4.9	1000	64
110	125	M3GP 315 MLA	3GGP 314 410-••G	740	95.0	95.0	0.83	203	7.3	1420	1.8	2.7	5.8	1150	72
132	150	M2BA 355 S	3GBA 354 100-••A	742	95.0	94.9	0.80	250	5.8	1699	1.5	2.3	10.4	1550	75
160	180	M2BA 355 SMA	3GBA 354 210-••A	742	95.2	95.1	0.80	305	6.3	2059	1.7	2.4	12.5	1800	75
200	230	M2BA 355 MLA	3GBA 354 410-••A	743	95.5	95.1	0.77	395	6.6	2571	1.8	2.7	14.6	2100	75
250	285	M2BA 355 MLC	3GBA 354 430-••A	744	95.7	95.4	0.80	470	6.6	3209	1.5	3.0	15.8	2100	75
200	230	M2BA 400 M	3GBA 404 300-••A	743	95.5	95.1	0.77	395	6.6	2571	1.8	2.7	14.6	2150	75
250	285	M2BA 400 MA	3GBA 404 310-••A	744	95.7	95.4	0.80	470	6.6	3209	1.5	3.0	15.8	2150	75
315	360	M2BA 400 LKA	3GBA 404 510-••A	744	96.0	95.9	0.79	605	6.3	4043	1.4	2.6	16.5	2800	80
355	400	M2BA 400 LKB	3GBA 404 520-••A	744	96.2	96.0	0.79	680	6.6	4557	1.5	2.7	19	3050	80

750 r/min = 8 poles				400 V 50 Hz ¹⁾				High-output design							
18.5	21	M3GP 200 MLB	3GGP 204 420-••G	734	90.3	90.5	0.79	37.5	6.9	241	2.2	3.2	0.54	300	57
30	34 ²⁾	M3GP 225 SMC	3GGP 224 230-••G	731	90.3	90.7	0.76	63	6.3	392	2.3	3.0	0.75	375	59
37	42	M3GP 250 SMB	3GGP 254 220-••G	737	92.8	92.7	0.77	75	7.5	479	2.3	3.4	1.52	465	65
55	65	M3GP 280 SMC	3GGP 284 230-••G	741	94.4	94.3	0.80	105	7.9	709	1.9	3.1	2.85	725	65

¹⁾ Motors are certified for the voltages 380-400-415 V 50 Hz according to IEC 60034-1. Values above are given for 400 V 50 Hz; data for other voltages on request.

²⁾ Temperature rise class F

ATEX certification process ongoing for frame sizes 355-400.

Please note that the frequency converter application in critical conditions may require special rotor design within 355 to 400 frame motors. We therefore recommend a separate checking.

Notes:

- When ordering sizes 160-200 with lifetime lubrication, variant code 195 'Bearings greased for life' has to be added.

Data for other voltages and frequencies, on request.

The two bullets in the product code indicate choice of mounting arrangement (see ordering information), voltage and frequency (below).

S	D	A ^{a)}	B ^{a)}	E	F ^{b)}	X
380 VY 50 Hz	380 VΔ 50 Hz	380 VY 50 Hz	380 VΔ 50 Hz	500 VΔ 50 Hz	500 VY 50 Hz	Other rated voltage, connection or frequency, max. 690 V
400 VY 50 Hz	400 VΔ 50 Hz	220 VΔ 50 Hz	660 VY 50 Hz	575 VΔ 60 Hz		
415 VY 50 Hz	415 VΔ 50 Hz	G ^{a)}	H ^{a)}	T ^{b)}	U ^{b)c)}	
220 VΔ 50 Hz	660 VY 50 Hz					415 VY 50 Hz
230 VΔ 50 Hz	690 VY 50 Hz ^{g)}					
440 VΔ 60 Hz	440 VΔ 60 Hz					

^{a)} On request for motor sizes 315-400.

^{b)} On request for motor sizes 355-400.

^{g)} Motor sizes 80-250: Not permitted for Ex N acc. to BS 5000:16. Motor sizes 280-400 available on VTT certificate.

Rating plates



For motor sizes 90 to 132 the rating plate gives one current value for the voltage area. That is the highest current that can occur within the voltage area with the given output. Aluminium motors, frame sizes 90 to 100, are self-certified.

For motor sizes 160 to 400 the rating plate is in table form giving values for speed, current and power factor for six voltages.

European standards require a special marking on safety motors. The marking shall include the following:

- type of protection
- apparatus group
- temperature class
- name of certifying body
- certificate number

M3AAN 90-100

ABB Automation Products, S.A. 						
Polígono Industrial S.O. Sant Quirze del Valles 08192-Barcelona-Spain						
3~Motor M3AAN 090 L-2 CL.F IP 55 IEC 34-1						
3GAA091002-AEA						
Nº						
V	Hz	r/min	kW	A	Cos φ	
500 D	50	2870	2,20	3,70	0,86	
Exn A II T3						
 II 3G 2002				16,00 kg		
6305 2Z/C3				6204 2Z/C3		



M2AA 112-132

ABB						
3~Motor M2AA 132 CL.F IP 55 IEC 34-						
3G AA 132 001-ADA, 94						
No.						
V	Hz	r/min	kW	A	cos φ	
380-420 Δ	50	1450	5,5	11,5	0,83	
660-690 Y	50	1450	5,5	6,6	0,83	
440-480 Δ	60	1750	6,4	11,5	0,83	
Ex n II T3 IEC 79-15						
6208				6206 40 Kg		

M2AA 160-250

ABB Motors									
3~Motor M2AA 200 MLA									
IEC 200 S M 55									
No.									
Ins.cl. F IP 55									
V	Hz	kW	r/min	A	cos φ	η	λ	λ ₁	λ ₂
690 Y	50	30	1475	32,5	0,83				
400 Δ	50	30	1475	56	0,83				
660 Y	50	30	1470	34	0,83				
380 Δ	50	30	1470	59	0,83				
415 Δ	50	30	1475	54	0,83				
440 Δ	60	35	1770	59	0,83				
Prod.code 3GAA 202 001-AXA, 97									
Ex n II T3 IEC 79-15									
6312/C3				6210/C3			180 kg		
IEC 34-1									

M2BA 71-132

ABB Motors 						
3-Mot. M2BA 132 SA2 CL.F IP 55 IEC34-1						
3GBA 131110-ASA / EEx nA II T3 / II 3G / 2000						
6208/C3  6207/C3						
V	Hz	r/min	kW	cos φ	A	
220-240 Δ	50	2920	5,5	0,89	18,5	
380-420 Y	50	2920	5,5	0,89	10,7	
460 Y	50	3510	6,33	0,88	10,2	
No. 2909200610 / LCIE 00 ATEX 6007 58 kg						

M3GP 160-315

ABB Oy, Electrical Machines LV Motors, Vaasa, Finland						
3~Motor M3GP 200MLB 4 ExnA II T3 B3						
IEC 200M/L 55						
S1						
No. 3445665						
M7-1010-1/2001 Ins.cl. F IP 55						
V	Hz	kW	r/min	A	cos φ	Duty
690 Y	50	30	1475	32,5	0,84	
400 D	50	30	1475	56	0,84	
660 Y	50	30	1471	34	0,85	
380 D	50	30	1471	59	0,85	
415 D	50	30	1477	54	0,83	
440 D	60	35	1769	59	0,85	
Prod.code 3GGP202420-ADG						
LCIE Ex00.016						
6312/C3				6310/C3 305 kg		
ABB IEC 60034-1						

Variant codes - Non-sparking motors

Variant codes / Non-sparking motors		Aluminium motors				Cast iron motors			
Code ¹⁾	Variant	90-100	112-132	160-180	200-250	71-132	160-250	280-315	355-400
Balancing									
052	Balancing to grade R (ISO 2373).	P	P	P	P	M	P	P	P
417	Balancing to grade S (ISO 2373).	-	R	R	R	P	P	P	P
424	Full key balancing.	P	P	P	P	M	P	P	P
Bearings and lubrication									
036	Transport lock for bearings.	-	M	M	M	-	M	P	P
037	Roller bearing at D-end.	-	-	P	P	-	M	P	P
039	Cold resistant grease (-55...+100°C).	M	M	M	M	M	M	P	P
040	Heat resistant grease (-25...+150°C). Aluminium motors sizes 63-100: -40...+160°C.	S	S	S	S	M	S	S	S
041	Bearings regreasable via grease nipples.	P	M	M	S	-	S	S	S
194	ZZ-bearings at both ends. Cast iron motor sizes 160-250 available as stocked option with lifetime bearings.	S	S	S	R	S	M	R	-
042	Locked drive-end.	S	R	S	R	R	S	S	S
043	SPM-nipples.	-	M	M	M	-	S	S	S
058	Angular contact bearing at D-end, shaft force away from bearing	R	M	M	M	-	P	P	P
107	Bearing mounted PT100 resistance elements.	-	-	-	-	-	P	P	P
433	Grease relief.	-	-	-	-	-	-	P	P
Brakes									
412	Built-on brake. Branch standard designs.	-	-	-	-	-	R	R	R
Branch standard designs									
142	"Manilla" winding connection, (440 VD series, 220 VD parallel, 60 Hz)	-	P	P	P	-	P	P	P
178	Stainless steel/acid proof bolts.	M	M	M	M	M	M	P	P
209	Non-standard voltage or frequency (special winding).	R	P	P	P	R	P	P	P
411	Increased efficiency design.	R	R	R	R	-	R	R	R
425	Corrosion protected stator and rotor core.	R	P	P	P	-	S	P	P
Cooling system									
044	Unidirectional fan, clockwise seen from D-end.	-	-	-	-	-	-	R	R
045	Unidirectional fan, counter clockwise seen from D-end.	-	-	-	-	-	-	R	R
068	Metal fan.	-	-	-	-	M	P	P	P
075	Cooling method IC 418 (without fan).	-	R	R	R	R	P	P	P
183	Separate motor cooling (fan axial, N-end).	R	R	R	R	-	P	P	P
422	Separate motor cooling (fan top or side, N-end).	-	-	-	-	-	-	P	P
791	Stainless steel fan cover.	-	-	-	-	-	R	R	R
Coupling									
035	Assembly of customer supplied coupling-half.	-	-	-	-	M	M	M	M
Drain holes									
065	Plugged drain holes.	-	S	S	S	M	M	P	P
066	Modified drain hole position (for specified IM xxxx).	M	-	-	-	M	M	P	P
076	Draining holes with plugs.	S	-	-	-	M	S	S	S

¹⁾ Certain variant codes cannot be used simultaneously.

S = Included as standard.
M = On modification of a stocked motor, or on new manufacture, the number per order may be limited.

P = New manufacture only.
R = On request.
- = Not available

Variant codes / Non-sparking motors		Aluminium motors				Cast iron motors			
Code ¹⁾	Variant	90-100	112-132	160-180	200-250	71-132	160-250	280-315	355-400
Hazardous environments									
407	Ex N design, fulfilling BS5000/16, certificate provided.	–	–	–	–	–	–	P	P
455	Ex N design, fulfilling BS5000/16, without certificate.	–	–	–	–	–	–	P	P
456	Ex nA design, fulfilling IEC 79-15, certificate provided.	–	–	–	–	S	S	S	S
457	Ex nA design, fulfilling IEC 79-15, without certificate.	S	–	–	–	–	P	P	P
480	EEx nA fulfilling EN 50021.	–	–	–	–	M	M	(M)	–
Heating elements									
450	Heating element, 110-120 V.	–	R	R	R	M	M	M	M
451	Heating element, 220-240 V.	–	R	R	R	M	M	M	M
Insulation system									
014	Winding insulation class H.	–	R	R	R	–	R	P	P
405	Special winding insulation for frequency converter supply.	–	R	R	R	–	P	P	P
Marine motors									
See catalogue 'Marine Motors, BA/Marine GB', for details.									
Mounting arrangements									
008	IM 2101 foot/flange mounted, IEC flange, from IM 1001 (B34 from B3).	–	M	R	–	M	–	–	–
009	IM 2001 foot/flange mounted, IEC flange, from IM 1001 (B35 from B3).	–	M	M	M	M	M	M	M
047	IM 3601 flange mounted, IEC flange, from IM 3001 (B14 from B5), flange mounted with large flange. Small flange with tapped holes.	–	M	R	–	M	–	–	–
Painting									
114	Special paint colour, standard grade.	P	M	M	M	M	M	M	M
111	Offshore two-pack polyamide cured epoxy paint 160 µm.	R	R	R	R	–	P	P	P
115	Offshore, zinc primer painting.	R	R	R	R	–	P	P	P
179	Special paint specification.	R	R	R	R	R	R	R	R
Protection									
072	Radial seal at D-end.	–	R	R	R	M	M	M	M
073	Sealed against oil at D-end.	–	–	–	–	R	P	P	P
005	Protective roof, vertical motor, shaft down.	M	S	S	S	M	M	M	M
158	Degree of protection IP 65.	–	M	M	M	M	M	P	P
211	Weather protected, IPwx.	–	–	–	–	P	P	P	P
401	Protective roof, horizontal motor.	–	–	–	–	–	–	P	P
403	Degree of protection IP 56.	–	M	M	M	M	M	P	P
404	Degree of protection IP 56, without fan.	–	–	–	–	R	P	P	P
783	Labyrinth sealing at D-end.	–	–	–	–	–	P	P	P
Rating & instruction plates									
002	Restamping voltage, frequency and output, continuous duty.	R	R	R	R	R	R	R	R
095	Restamping output (maintained voltage, frequency), frequency), intermittent duty.	R	R	R	R	–	–	–	–
138	Mounting of additional identification plate.	M	M	M	M	M	M	M	M
139	Additional identification plate delivered loose.	M	M	M	M	M	M	M	M
150	Instruction plates and maintenance instructions in non-standard language.	–	–	–	–	R	R	R	R
161	Additional rating plate delivered loose.	M	M	M	M	M	M	M	M

¹⁾ Certain variant codes cannot be used simultaneously.

S = Included as standard.
M = On modification of a stocked motor, or on new manufacture, the number per order may be limited.

P = New manufacture only.
R = On request.
– = Not available

Variant codes / Non-sparking motors		Aluminium motors				Cast iron motors			
Code ¹⁾	Variant	63-100	112-132	160-180	200-250	71-132	160-250	280-315	355-400
Shaft & rotor									
069	Two shaft extensions as per basic catalogue.	P	P	P	P	–	P	P	P
070	One or two special shaft extensions, standard shaft material.	P	P	P	P	–	P	P	P
155	Cylindrical shaft extension, D-end, without key-way.	–	–	–	–	–	P	P	P
156	Cylindrical shaft extension, N-end, without key-way.	–	–	–	–	–	P	P	P
164	Shaft extension with closed key-way.	S	S	S	S	P	S	P	P
165	Shaft extension with open key-way	–	P	P	P	S	P	S	S
410	Stainless/acid-proof steel shaft (standard or non-standard design).	R	R	R	R	–	P	P	P
431	Special shaft material for low temperatures, < -40°C	–	–	–	–	P	P	P	P
Standards and regulations									
152	Classified shaft material.	–	–	–	–	–	P	P	P
421	VIK design (Verband der industriellen Energie- und Kraftwirtschaft e.V.).	–	–	–	–	M	M	P	P
773	EEMUA (No 132 1988) design.	–	–	–	–	R	R	P	P
774	NORSOK (North Sea Territorial Waters) design.	–	–	–	–	R	R	P	P
775	SHELL DEP 33.66.05.31-Gen. January 1999 design.	–	–	–	–	M	M	P	P
Stator winding temperature sensors									
435	PTC - thermistors (3 in series), 130°C, in stator winding.	P	R	M	M	P	M	M	M
436	PTC - thermistors (3 in series), 150°C, in stator winding.	P	R	M	S	S	S	S	S
439	PTC - thermistors (2x3 in series), 150°C, in stator winding.	R	R	M	M	P	P	P	P
441	PTC - thermistors (3 in series 130°C & 3 in series 150°C), in stator winding.	R	R	M	M	P	P	P	P
445	PT100 resistance element (1 per phase) in stator winding.	–	–	–	–	–	P	P	P
446	PT100 resistance element (2 per phase) in stator winding.	–	–	–	–	–	P	P	P
Terminal box									
015	Δ connection in terminal box (reconnection from Y).	M	M	M	M	M	M	M	M
017	Y connection in terminal box (reconnection from Δ).	M	M	M	M	M	M	M	M
021	Terminal box LHS (seen from D-end).	–	–	–	P	–	P	P	P
136	Extended cable connection, standard terminal box. M2AA motors: 2 m long connection cable.	–	–	–	–	R	R	R	R
137	Extendend cable connection, low terminal box.	–	–	–	–	–	P	P	P
157	Terminal box degree of protection IP 65.	–	–	–	–	M	M	M	M
180	Terminal box RHS (seen from D-end).	–	–	–	P	P	P	P	P
400	4 x 90 degr turnable terminal box. Cast iron sizes 200-250 = S	–	–	–	–	–	S	P	P
402	Terminal box adapted for Al cables.	–	–	–	R	–	–	S	S
413	Extended cable connection, no terminal box.	–	–	–	–	–	–	P	P
418	Separate terminal box for temperature detectors.	R	R	R	R	–	M	P	P
466	Terminal box at N-end.	–	–	–	–	–	R	R	R
468	Non-standard cable entry direction (state cable direction).	–	–	–	–	M	P	P	P
469	Axial cable entry direction.	–	–	–	–	M	P	P	P
731	Non-standard cable glands.	–	–	–	–	R	M	M	M
736	EEx e II certified cable gland, fulfilling EN 50014 and 50019 Eex d = -, Eex de = S	–	–	–	–	M	S	S	S

¹⁾ Certain variant codes cannot be used simultaneously.

S = Included as standard.
M = On modification of a stocked motor,
or on new manufacture,
the number per order may be limited.

P = New manufacture only.
R = On request.
– = Not available

Variant codes / Non-sparking motors		Aluminium motors				Cast iron motors			
Code ¹⁾	Variant	63-100	112-132	160-180	200-250	71-132	160-250	280-315	355-400
737	EEx e II certified cable gland with clamping device, fulfilling EN 50014 and 50019. Eex d = -, Eex de = M.	-	-	-	-	M	M	M	M
740	Prepared for PG cable glands.	-	-	-	-	-	P	P	P
741	Motor equipped with EEx e terminal box (EN 50019).	-	-	-	-	-	P	P	P
Testing									
140	Test confirmation.	M	M	M	M	-	-	-	-
145	Type test report from test of identical motor.	R	M	M	M	M	M	M	M
146	Type test with report for motor from specific delivery batch.	P	M	M	M	M	M	P	P
147	Type test with report for motor from specific delivery batch, customer witnessed.	P	M	M	M	M	M	P	P
148	Routine test report.	R	M	M	M	M	M	P	P
221	Type test and multi-point load test with report for motor from specific delivery batch.	-	M	M	M	-	P	P	P
222	Torque/speed curve, type test and multi-point load test with report from specific delivery batch.	-	M	M	M	-	P	P	P
760	Vibration level test.	R	M	M	M	M	M	P	P
761	Vibration spectrum test.	R	R	R	R	-	P	P	P
762	Noise level test.	R	M	M	M	P	P	P	P
763	Noise spectrum test.	R	R	R	R	P	P	P	P
764	Complete test with ABB frequency converter.	-	R	R	R	P	P	P	P
768	Chog type test with report for motor from specific delivery batch.	-	-	-	-	R	P	R	R
769	Chog type test report from test of identical motor.	-	-	-	-	R	P	R	R
Variable speed drives									
181	Adapted for frequency converter, variable speed operation.	R	-	-	-	M	M	M	M
405	Special winding insulation for frequency converter supply, rated supply > 500 V.	-	R	R	R	-	P	P	P
701	Insulated bearing at N-end. Note: In variable speed drives all Ex-motors size 280 and above must be equipped with insulated bearings (see p 110).	-	-	-	-	-	R	P	P
704	EMC cable gland.	-	-	-	-	-	-	P	P
Separate cooling									
183	Separate motor cooling (fan axial, N-end).	-	-	-	-	-	P	P	P
422	Separate motor cooling (fan top or side, N-end).	-	-	-	-	-	-	P	P
Tacho									
747	EEx d pulse tacho.	-	-	-	-	-	P	P	P
Separate motor cooling & tacho									
476	Separate motor cooling (fan axial, N-end) and 1024 pulse tacho (Leine & Linde type EEx e 840 mounted).	-	-	-	-	-	P	P	P
477	Separate motor cooling (fan axial, N-end) and 2048 pulse tacho (Leine & Linde type EEx e 840) mounted.	-	-	-	-	-	P	P	P
Y/Δ-starting									
117	Terminals for Y/Δ start at both speeds (two-speed windings).	-	-	P	P	-	R	P	P
118	Terminals for Y/Δ start at high speed (two-speed windings).	-	P	-	-	-	R	P	P
119	Terminals for Y/Δ start at low speed (two-speed windings).	-	-	-	-	-	R	P	P

¹⁾ Certain variant codes cannot be used simultaneously.

S = Included as standard.
M = On modification of a stocked motor, or on new manufacture, the number per order may be limited.

P = New manufacture only.
R = On request.
- = Not available

Dimension drawings

M3000 Non-sparking motors, aluminium frame

Foot-mounted motor IM 1001, IM B3

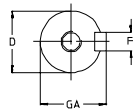
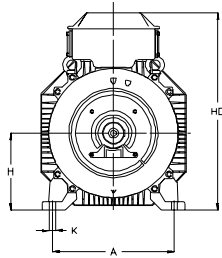
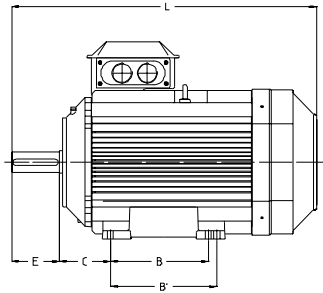

Shaft extension

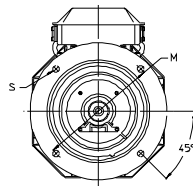

Flanges

Sizes 90-200

Flange-mounted motor IM 3001, IM B5

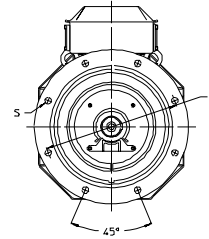
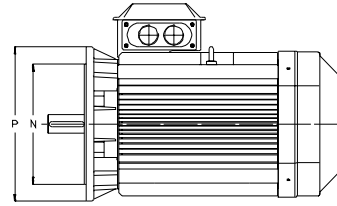

Sizes 225-250

Motor size	IM 1001, IM B3 AND IM 3001, IM B5						IM 1001, IM B3						IM 3001, IM B5								
	D poles		GA poles		F poles		E poles		L max poles		A	B	B'	C	HD	K	H	M	N	P	S
	2	4-8	2	4-8	2	4-8	2	4-8	2	4-8											
90 S	24	24	27	27	8	8	50	50	295	295	140	100	—	56	212	10	90	165	130	200	12
90 L	24	24	27	27	8	8	50	50	320	320	140	125	—	56	212	10	90	165	130	200	12
100 L	28	28	31	31	8	8	60	60	358.5	358.5	160	140	—	63	236	12	100	215	180	250	15
112 M	28	28	31	8	8	8	60	60	361	361	190	140	—	70	258	12	112	215	180	250	14.5
132	38	41	41	41	10	10	80	80	447	447	216	140	178	89	295.5	12	132	265	230	300	14.5
160¹⁾	42	42	45	45	12	12	110	110	602.5	602.5	254	210	254	108	370	15	160	300	250	350	19
160²⁾	42	42	45	45	12	12	110	110	643.5	643.5	254	210	254	108	370	15	160	300	250	350	19
180³⁾	48	51.5	51.5	51.5	14	14	110	110	680	680	279	241	279	121	405	15	180	300	250	350	19
180⁴⁾	48	51.5	51.5	51.5	14	14	110	110	700.5	700.5	279	241	279	121	405	15	180	300	250	350	19
200 ML	55	55	59	59	16	16	110	110	773	773	318	267	305	133	496.5	18	200	350	300	400	19
225 SM	55	60	59	64	16	18	110	110	835	865	356	286	311	149	542	18	225	400	350	450	19
250 SM	60	65	64	69	18	18	140	140	872	872	406	311	349	168	590	22	250	500	450	550	19

IM 3601, IM B14

Motor size	HB	LA	M	N	P	S	T
90	122	14	115	95	140	M8	3
100	136	16	130	110	160	M8	3.5
112	146	20	130	130	160	M8	3.5
132	163.5	18	165	165	200	M10	3.5

Tolerances:

A, B	± 0.8
D, DA	ISO k6 < Ø 50mm ISO m6 > Ø 50mm
F, FA	ISO h9
H	+0 -0.5
N	ISO j6
C, CA	± 0.8

¹⁾ MA2, M2, L2, LB2, M4, L4, LB4, M6, L6, M28, M8

²⁾ LB6, L8, LB8

³⁾ M2, LB2, M4, L6, L8

⁴⁾ L4, LB4, LB6, LB8

Above table gives the main dimensions in mm.

For detailed drawings please check our web-pages
'www.abb.com/motors&drives' or contact ABB.

Dimension drawings

M3000 Non-sparking motors, cast iron frame

Foot-mounted motor IM 1001, IM B3 Flange-mounted motor IM 3001, IM B5

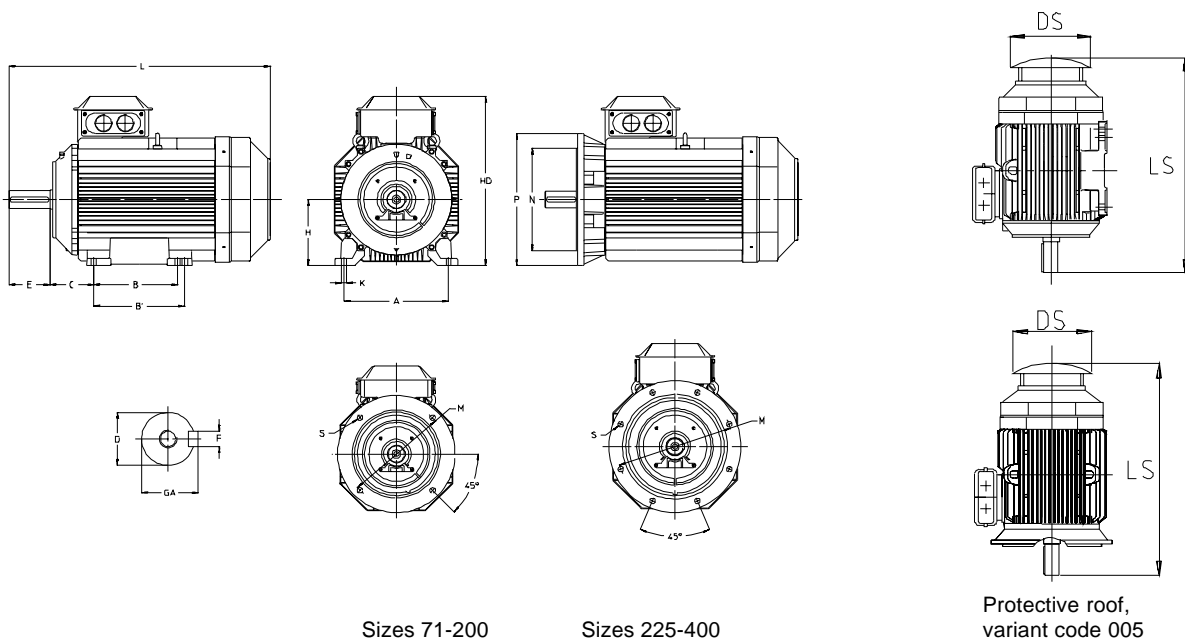

Sizes 71-200

Sizes 225-400

Protective roof,
variant code 005

Motor size	IM 1001, IM B3 AND IM 3001, IM B5						IM 1001, IM B3						IM 3001, IM B5				Protective roof							
	D poles 2 4-8		GA poles 2 4-8		F poles 2 4-8		E poles 2 4-8		L max poles 2 4-8		A	B	B'	C	HD	K	H	M	N	P	S	DS	LS poles 2 4-8	
71	14	14	16	16	5	5	30	30	250	250	112	90	-	45	190	7	71	130	110	160	10	140	275	275
80	19	19	21.5	21.5	6	6	40	40	282	282	125	100	-	50	220	10	80	165	130	200	12	155	320	320
90 S	24	24	27	27	8	8	50	50	310	310	140	100	-	56	235	10	90	165	130	200	12	175	345	345
90 L	24	24	27	27	8	8	50	50	335	335	140	125	-	56	235	10	90	165	130	200	12	175	370	370
100	28	28	31	31	8	8	60	60	380	380	160	140	-	63	270	12	100	215	180	250	15	195	410	410
112	28	28	31	31	8	8	60	60	395	395	190	140	-	70	290	12	112	215	180	250	15	220	425	425
132 S	38	38	41	41	10	10	80	80	462	462	216	140	-	89	330	12	132	265	230	300	15	260	490	490
132 M	38	38	41	41	10	10	80	80	500	500	216	178	-	89	330	12	132	265	230	300	15	260	530	530
160	42	42	45	45	12	12	110	110	711	711	254	210	254	108	388	14.5	160	300	250	350	18.5	328	756	756
180	48	48	51.5	51.5	14	14	110	110	706	706	279	241	279	121	426	14.5	180	300	250	350	18.5	359	756	756
200	55	55	59	59	16	16	110	110	774	774	318	267	305	133	536	18.5	200	350	300	400	18.5	414	844	844
225	55	60	59	64	16	18	110	140	841	871	356	286	311	149	583	18.5	225	400	350	450	18.5	462	921	951
250	60	65	64	69	18	18	140	140	875	875	406	311	349	168	646	24	250	500	450	550	18.5	506	965	965
280 SM	65	75	69	79.5	18	20	140	140	1088	1088	457	368	419	190	762	24	280	500	450	550	18	555	1190	1190
315 SM	65	80	69	85	18	22	140	170	1174	1204	508	406	457	216	852	30	315	600	550	660	23	624	1290	1320
315 ML	65	90	69	95	18	25	140	170	1285	1315	508	457	508	216	852	30	315	600	550	660	23	624	1401	1431
355 S	70	100	74.5	106	20	28	140	210	1344	1414	610	500	-	254	955	35	355	740	680	800	23	720	1476	1546
355 SM	70	100	74.5	106	20	28	140	210	1396	1466	610	500	560	254	955	35	355	740	680	800	23	720	1528	1703
355 ML	70	100	74.5	106	20	28	140	210	1501	1571	610	560	630	254	955	35	355	740	680	800	23	720	1633	1703
400 M	70	100	74.5	106	20	28	140	210	1501	1571	686	630	-	280	1005	35	400	-	-	-	-	810	1860	1900
400 LK	80	100	85.0	106	22	28	170	210	1708	1748	686	710	800	280	1040	35	400	740	680	800	23	810	1860	1900

IM 3601, IM B14

Motor size	Flange size	P	M	N	S	T
71	C105	105	85	70	M6	2.5
71	C140	140	115	95	M8	3
80	C120	120	100	80	M6	3
80	C160	160	130	110	M8	3.5
90	C140	140	115	95	M8	3
90	C160	160	130	110	M8	3.5
100, 112	C160	160	130	110	M8	3.5
100, 112	C200	200	165	130	M10	3.5

Tolerances:

A, B	± 0,8	H	+0 -0.5
D, DA	ISO k6 < Ø 50mm	N	ISO j6
	ISO m6 > Ø 50mm	C, CA	± 0.8
F, FA	ISO h9		

Above table gives the main dimensions in mm.

For detailed drawings please check our web-pages
'www.abb.com/motors&drives' or contact ABB.

Dimension drawings

Cast iron frame

Terminal boxes, standard design with 6 terminals

Motor sizes 71 - 132

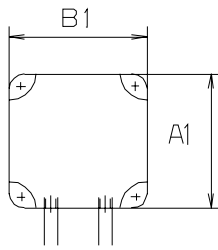

Motor sizes 160 - 250

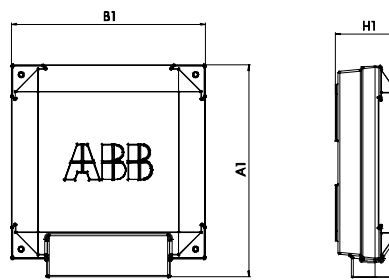

Motor sizes 280-315, top- and side-mounted
210/1, 370/1

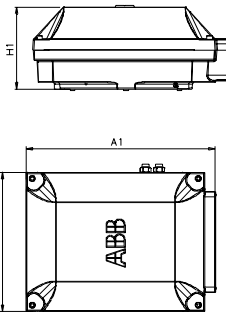

Motor sizes 355-400 top-mounted:
142/1, 142/2

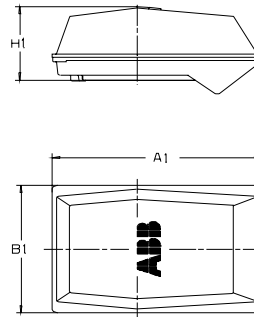

Motor sizes 355-400, top-mounted
162/1, 162/2 + adaptor MPMM-ZL1

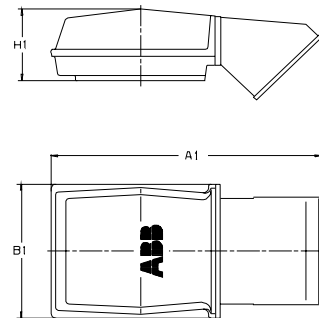

Motor sizes 355-400 side-mounted:
142/5, 142/10, 162/5, 162/8

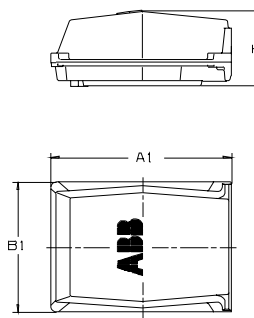

Motor size	A1	B1	H1
80 - 90	124	114	58
100 - 132	134	124	68
160 - 180	240	220	79.5
200 - 250	347.5	310	140.9

Terminal box type	Motor size	A1	B1	H1
210/1	280	416	306	177
370/1	315, 355	451	347	200
Top-mounted:				
142/1, 142/2	355-400	536	349	197
162/1, 162/2 + Adaptor MPMM-ZL1	355 - 400	787	410	226
Side-mounted:				
142/5, 142/10				
162/5, 162/8	355 - 400	508	412	226

For motor dimensions please see dimension drawings on earlier pages.

Non-sparking motors with aluminium frame in brief, basic design

Motor size		90	100	112	132
Stator	Material	Die-cast aluminium alloy. Feet integrated with stator.		Die-cast aluminium alloy.	
	Surface treatment	Munsell blue 8B 4.5/3.25 / NCS 4822-B05G. Powder coating based on polyester resin, ≥ 60 µm.		Polyester powder paint ≥ 50 µm.	
Feet	Material	Aluminium alloy. Integrated with the stator.			
Bearing end shields	Material	Diecast aluminium alloy. Munsell blue 8B 4.5/3.25 / NCS 4822-B05G.		Polyester powder paint ≥ 50 µm.	
	Surface treatment	One-component modified polyester paint ≥ 30 µm.			
Bearings Single-speed motors	D-end	6305-2Z/C3	6306-2Z/C3	6206-2Z/C3	6208-2Z/C3
	N-end	6204-2Z/C3	6205-2Z/C3	6205-2Z/C3	6206-2Z/C3
Axially-locked bearings	Inner bearing cover	D-end 112-132: Foot-mounted - a spring washer at N-end presses the rotor against D-end. Flange-mounted - inner bearing cover and spring-washer at N-end.			
Bearing seal	D-end N-end	V-ring. Labyrinth seal. Two-speed 112, 132 M, V-ring. Other labyrinth seal.			
Lubrication		Permanently lubricated bearings. Grease for bearing temperatures -40 to +160°C.			
Terminal box	Material	Die-cast aluminium alloy.		Die-cast aluminium alloy. Base integrated with stator.	
	Surface treatment	Similar to stator.			
	Screws	Steel 5G. Galvanised and yellow chromated.			
Connections	Knock-out openings	4 x M20		4 x (M25 + M20)	
	Terminal box	Screw terminal. 6 terminals.		Cable lugs. 6 terminals.	
	Max Cu-area, mm ²	4		M5 / 10	
Fan	Material	Polypropylene. Reinforced with 20% glass fibre.			
Fan cover	Material	Polypropylene.			
Stator winding	Material Impregnation Insulation class Winding protection	Copper Polyester vanish. Tropicalised. Insulation class F. Temperature rise class B, unless otherwise stated. On request, see variant codes.			
Rotor winding	Material	Die-cast aluminium.			
Balancing method		Half key balancing.			
Key ways		Closed key way			
Enclosure		IP 55			
Cooling method		IC 411			
Drain holes		Drain holes with closable plastic plugs. Open on delivery.			

Non-sparking motors with aluminium frame in brief, basic design

Motor size		160	180	200	225	250
Stator	Material Surface treatment	Die-cast aluminium alloy. Polyester powder paint. Munsell blue 8B 4.5/3.25 / NCS 4822-B05G. $\geq 50 \mu\text{m}$.		Extruded aluminium alloy.		
Feet	Material	Aluminium alloy. Integrated with the stator.		Aluminium alloy, bolted to the stator.		250-2, cast iron
Bearing end shields	Material Surface treatment	Flanged bearing end shields of cast iron, other die-cast aluminium alloy Two-component oxyranester paint, Munsell blue 8B 4.5/3.25 / NCS 4822-B05G. $\geq 50 \mu\text{m}$.				
Bearings Single-speed motors	D-end N-end	6309-2Z/C3 6209-2Z/C3	6310-2Z/C3 6209-2Z/C3	6312/C3 6210/C3	6313/C3 6212/C3	6315/C3 6213/C3
Axially-locked bearings	Inner bearing cover	D-end	D-end	D-end	D-end	D-end
Bearing seal	D-end N-end	V-ring. Labyrinth seal.		Outer and inner V-rings. Outer and inner V-rings.		
Lubrication		Permanently lubricated bearings. Grease for bear. temp. -40 to $+160^\circ\text{C}$.		Valve lubrication. Grease for bearing temperatures -40 to $+150^\circ\text{C}$.		
Terminal box	Material Surface treatment Screws	Die-cast aluminium alloy. Base integrated with stator. Similar to stator. Steel 5G. Galvanised and yellow chromated.		Deep-drawn steel sheet, bolted to stator. Phosphated. Polyester paint.		
Connections	Knock-out openings	2 x (2 x M40 + M16)				
	Flange-openings			2 x FL 13.2 x M40		
	Flange-openings for voltage code S			2 x FL 21.2 x M63		
	Terminal box	Cable lugs. 6 terminals.				
	Max Cu-area, mm ²	M6 35	M6 35	M10 70	M10 70	M10 70
Fan	Material	Polypropylene. Reinforced with 20% glass fibre.				
Fan cover	Material Surface treatment	Steel sheet. ¹⁾ Also two-speed sizes 112 and 132 M. ¹⁾ Phosphated. Polyester paint.				
Stator winding	Material Impregnation Insulation class Winding protection	Copper Polyester vanish. Tropicalised. Insulation class F. Temperature rise class B, unless otherwise stated. On request, see variant codes			PTC-thermistors, 150°C	
Rotor winding	Material	Die-cast aluminium.				
Balancing method		Half key balancing.				
Key way		Closed key way				
Enclosure		IP 55				
Cooling method		IC 411				
Drain holes		Drain holes with closable plastic plugs. Open on delivery.				

Non-sparking motors with cast iron frame in brief, basic design

Motor size		71	80	90	100	112	132	160	180	
Stator	Material	Cast iron EN-GJL-200								
	Paint colour shade	Blue, Munsell 8B 4.5/3.25 / NCS 4822 B05G								
	Paint thickness	Two-pack PUR-paint, thickness $\geq 60 \mu\text{m}$						Two-pack epoxy paint, thickness $\geq 80 \mu\text{m}$		
Bearing end shields	Material	Cast iron EN-GJL-150						Cast iron EN-GJL-200		
	Paint colour shade	Blue, Munsell 8B 4.5/3.25 / NCS 4822 B05G								
	Paint thickness	Two-pack PUR-paint, thickness $\geq 60 \mu\text{m}$						Two-pack epoxy paint, thickness $\geq 80 \mu\text{m}$		
Bearings	D-end	2-pole	6202 2RS C3	6204 2RS C3	6205 2RS C3	6206 2RS C3	6207 2RS C3	6208 2RS C3	6309M/C3	6310M/C3
		4-12 -pole							6309/C3	6310/C3
	N-end	2-pole	6202 2RS C3	6204 2RS C3	6205 2RS C3	6206 2RS C3	6206 2RS C3	6207 2RS C3	6309M/C3	6309M/C3
		4-12 -pole							6309/C3	6309/C3
Axially-locked bearings	Inner bearing cover	On request						As standard, locked at D-end		
Bearing seal		2RS-integral seals						Gamma-ring asstd, radial seal on request		
Lubrication		Permanent grease lubrication.						Regreasable bearings as std, lifetime lubrication as stocked option		
SPM-nipples		-						As standard		
Rating plate	Material	Stainless steel 0.80 Cr 18 Ni9						Stainless steel		
Terminal box	Frame material	Cast iron EN-GJL-150						Cast iron EN-GJL-200		
	Cover material	Cast iron EN-GJL-150						Cast iron EN-GJL-200		
	Cover screws material	Steel 5G, coated with zinc and yellow cromated								
Connections	Cable entries	2xM16x1.5	2xM25x1.5	2xM25x1.5	2xM32x1.5	2xM32x1.5	2xM32x1.5	2xM40x1.5	2xM40x1.5	
	Terminals	6 terminals for connection with cable lugs (not included)								
Fan	Material	Reinforced glass fiber laminate or aluminium								
Fan cover	Material	Steel						Zinc coated steel		
	Paint colour shade	Blue, Munsell 8B 4.5/3.25 / NCS 4822 B05G								
	Paint thickness	Two-pack PUR-paint, thickness $\geq 60 \mu\text{m}$						Two-pack polyester paint, thickness $\geq 80 \mu\text{m}$		
Stator winding	Material	Copper								
	Insulation	Insulation class F								
	Winding protection	On request						3 pcs thermistors		
Rotor winding	Material	Pressure die-cast aluminium								
Balancing method		Half key balancing								
Key ways		Open key way						Closed key-way		
Drain holes		Optional						As standard, open on delivery		
Enclosure		IP 55, higher protection on request								
Cooling method		IC 411								

Non-sparking motors with cast iron frame in brief, basic design

Motor size		200	225	250	280	315	355	400
Stator	Material Paint colour shade	Cast iron EN-GJL-200 Blue, Munsell 8B 4.5/3.25 / NCS 4822 B05G						
	Paint thickness	Two-pack epoxy paint, thickness $\geq 80 \mu\text{m}$						
Bearing end shields	Material	Cast iron EN-GJL-200			Cast iron EN-GJL-200, except flange-mounted sizes 355-400 Spheroidal graphit EN-GJS-400			
	Paint colour shade	Blue, Munsell 8B 4.5/3.25 / NCS 4822 B05G						
	Paint thickness	Two-pack epoxy paint, thickness $\geq 80 \mu\text{m}$			Two-pack epoxy paint, thickness $\geq 70 \mu\text{m}$			
Bearings	D-end 2-pole 4-12 -pole	6312M/C3 6312/C3	6313M/C3 6313/C3	6315M/C3 6315/C3	6316/C3 6316/C3	6316/C3 6319/C3	6319M/C4 6322/C3	6319M/C4 6322/C3
	N-end 2-pole 4-12 -pole	6310M/C3 6310/C3	6312M/C3 6312/C3	6313M/C3 6313/C3	6316/C3 6316/C3	6316/C3 6316/C3	6319M/C4 6319/C3	6319M/C4 6319/C3
Axially-locked bearings	Inner bearing cover	As standard, locked at D-end						
Bearing seals		Gamma-ring as standard, radial seal on request			V-ring as standard, radial seal on request			
Lubrication		Regreasable bearings as standard, lifetime lubrication as stocked option			Regreasable bearings, regreasing nipples, M10x1			
SPM-nipples		As standard			Optional		As standard	
Rating plate	Material	Stainless steel						
Terminal box	Frame material	Cast iron EN-GJL-200			Cast iron EN-GJL-150			
	Cover material	Cast iron EN-GJL-200			Cast iron EN-GJL-150			
	Cover screws material	Steel 5G, coated with zinc and yellow cromated						
Connections	Cable-entries 2-, 4-pole 6-pole	2xM50x1.5	2xM50x1.5	2xM50x1.5	2xM63x1.5	2xM63x1.5	2xØ60/80 2xØ60	2xØ80 2xØ60/80
	Terminals	6 terminals for connection with cable lugs (not included)						
Fan	Material	Reinforced glass fiber laminate or aluminium			Reinforced glass fiber, aluminium or polypropylene with metal hub			
Fan cover	Material Paint colour shade	Zinc coated steel Blue, Munsell 8B 4.5/3.25 / NCS 4822 B05G			Steel			
	Paint thickness	Zinc coated steel			Two-pack epoxy polyester paint, thickness $\geq 80 \mu\text{m}$			
Stator winding	Material Insulation	Copper Insulation class F						
	Winding protection	3 pcs thermistors						
Rotor winding	Material	Pressure die-cast aluminium			Pressure die-cast aluminium or copper			
Balancing method		Half key balancing						
Key way		Closed key way			Open key way			
Drain holes		As standard, open on delivery						
Enclosure		IP 55, higher protection on request						
Cooling method		IC 411						

Motors for dust ignition protection (DIP)

Range

Range	Standards	Frame	Size	Output range
Category 2 D - T125°C - IP 65	EN 50281-1-1	aluminium	90 - 250	1.1 - 55 kW
		cast iron	80 - 355	0.55 - 500 kW
Category 3 D - T125°C - IP 55	EN 50281-1-1	aluminium	90 - 250	1.1 - 55 kW
		cast iron	71 - 355	0.25 - 500 kW

Terminal boxes

The terminal boxes of the dust ignition proof motors comply with the requirements of the standards for this type and have the same IP protection as the motors. Furthermore they prevent all ignition sources such as sparks, excessive overheating etc., and are equipped with no self-loosening terminals.

Terminal boxes are mounted on the top of the basic motor versions. The terminal box is either rotatable or at least allows cable entry from either side which gives a choice of connection possibilities.

Aluminium motors

In sizes 90 to 250 the terminal box is made of aluminium, the bottom section is integrated with the stator and provided with two openings on both sides.

Cast iron motors

The terminal boxes in motors 71-132 and 200-250 are 4x90° turnable as standard, in motor sizes 160 to 180 and 280-400 as standard 2x180° and as easy option 4x90°.

In sizes 80-132 the motors are provided with cast iron terminal boxes with tapped cable entry holes on one side. Cable glands can be provided on request, see variant codes. In frame sizes 160-250 the terminal box has two main metric cable entries; both are equipped with cable glands of closed type. In frame sizes 280-400 the terminal box has two main metric cable glands; one equipped with a cable gland, one with a metal plug.

Cable entries and cable glands

Cast iron motors up to size 132 are delivered without cable glands but are delivered with threaded cable entries suitable for the following cable gland sizes. In cast iron motor sizes 160 to 400 the terminal box is equipped with cable glands or cable boxes as standard.

Aluminium motors are delivered without cable glands

and knock-out openings as standard.

Cable glands for dust ignition proof motors are a very important equipment. To ensure that they are correctly dimensioned according to the cables used, we recommend that the installer of the motors supplies them.

Motor sizes 90-250 with aluminium frame

Motor size	Opening	Metric cable entry	Comparison Pg gland	Cable gland diameter mm, min-max.
90-100	Knock-out	4 x M20	4 x Pg16	Ø9 - 13
112-132	Knock-out	2 x (M25 + M20)	2 x (Pg 21 + Pg 16)	Ø11-16
160-180	Knock-out	4 x M40 + 2 x M20	4 x Pg 29 + 2 x Pg 9	Ø19-27 + Ø3-6
200	Knock-out	–	4 x Pg 36	Ø31-34.5
225-250	2 x FL13	–	4 x Pg 29	Ø24-27

Motor sizes 71-250 with cast iron frame

Motor size	Metric cable entry	Comparison Pg gland	Cable gland diameter mm, min-max.	Max. connection cable area mm ²	Terminal bolt size 6 x
71	2 x M16 x 1.5	2 x Pg 11	2x Ø5-10	6	M4
80-90	2 x M25 x 1.5	2 x Pg 16	2x Ø8-13	6	M4
100-112	2 x M32 x 1.5	2 x Pg 21	2x Ø15-20	16	M5
132	2 x M32 x 1.5	2 x Pg 21	2x Ø15-20	16	M5
160	2 x M40 x 1.5 + 2 x M20 x 1.5	2 x Pg 29 + 2 x Pg 13.5	2x Ø18-27	25	M6
180	2 x M40 x 1.5 + 2 x M20 x 1.5	2 x Pg 29 + 2 x Pg 13.5	2x Ø18-27	25	M6
200	2 x M50 x 1.5 + 2 x M20 x 1.5	2 x Pg 36 + 2 x Pg 13.5	2x Ø26-35	35	M10
225	2 x M50 x 1.5 + 2 x M20 x 1.5	2 x Pg 36 + 2 x Pg 13.5	2x Ø26-35	50	M10
250	2 x M50 x 1.5 + 2 x M20 x 1.5	2 x Pg 42 + 2 x Pg 13.5	2x Ø32-49	70	M10

Information on metric cable glands available from ABB on request.

Co-ordination of terminal boxes and cable entries

Cast iron motors sizes 280-400 motors with top-mounted terminal box

Motor size	Flange or adapter	Cable box or cable gland	Gland thread	Cable diameter	Max. connection cable area mm ²	Terminal bolt size	Voltage/frequency code
3000 r/min (2 poles)							
280	3GZF 294 730-749	2x 3GZF 294 730-613	2x M63x1.5	2x Ø32-49	2x150	M12	
315	3GZF 294 730-753	2x 3GZF 294 730-613	2x M63x1.5	2x Ø32-49	2x240	M12	
355 S	MPMM-ZL1	3GZF 294 730-301		2x Ø48-60	4x240	M12	D
	-	3GZF 294 730-301		2x Ø48-60	2x240	M12	E
355 SM_	MPMM-ZL1	3GZF 294 730-301		2x Ø48-60	4x240	M12	
355 ML_	MPMM-ZL1	LNPB 3328		2x Ø60-80	4x240	M12	
1500 r/min (4 poles)							
280	3GZF 294 730-749	2x 3GZF 294 730-613	2x M63x1.5	2x Ø32-49	2x150	M12	
315	3GZF 294 730-753	2x 3GZF 294 730-613	2x M63x1.5	2x Ø32-49	2x240	M12	
355 S	MPMM-ZL1	3GZF 294 730-301		2x Ø48-60	4x240	M12	D
	-	3GZF 294 730-301		2x Ø48-60	2x240	M12	E
355 SM_	MPMM-ZL1	3GZF 294 730-301		2x Ø48-60	4x240	M12	
355 ML_	MPMM-ZL1	LNPB 3328		2x Ø60-80	4x240	M12	
1000 r/min (6 poles)							
280	3GZF 294 730-749	2x 3GZF 294 730-613	2x M63x1.5	2x Ø32-49	2x150	M12	
315	3GZF 294 730-753	2x 3GZF 294 730-613	2x M63x1.5	2x Ø32-49	2x240	M12	
355 S, SMA	-	3GZF 294 730-301		2x Ø48-60	2x240	M12	
355 SMB	MPMM-ZL1	3GZF 294 730-301		2x Ø48-60	4x240	M12	D
	-	3GZF 294 730-301		2x Ø48-60	2x240	M12	E
355 ML_	MPMM-ZL1	3GZF 294 730-301		2x Ø48-60	4x240	M12	
750 r/min (8 poles)							
280	3GZF 294 730-749	2x 3GZF 294 730-613	2x M63x1.5	2x Ø32-49	2x150	M12	
315	3GZF 294 730-753	2x 3GZF 294 730-613	2x M63x1.5	2x Ø32-49	2x240	M12	
355 S, SMA	-	3GZF 294 730-301		2x Ø48-60	2x240	M12	
355 MLA	-	3GZF 294 730-301		2x Ø48-60	2x240	M12	
355 MLC	MPMM-ZL1	3GZF 294 730-301		2x Ø48-60	4x240	M12	D
	-	3GZF 294 730-301		2x Ø48-60	2x240	M12	E

Voltage/frequency codes:

D - 380-420 VΔ 50 Hz, 660-690 VY 50 Hz, 440-480 VΔ 60 Hz

E - 500 VΔ 50 Hz, 575 VΔ 60 Hz

Examples:

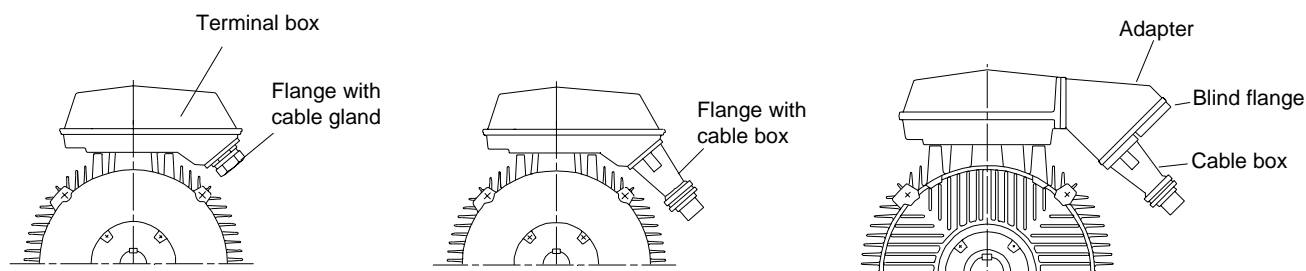

Co-ordination of terminal boxes and cable entries

Cast iron motors sizes 280-400 motors with side-mounted terminal box

Motor size	Flange or adapter	Cable box or cable gland	Gland thread	Cable diameter	Max. connection cable area mm ²	Terminal bolt size	Voltage/frequency code
3000 r/min (2 poles)							
280	3GZF 294 730-749	2x 3GZF 294 730-613	2x M63x1.5	2x Ø32-49	2x150	M12	
315	3GZF 294 730-753	2x 3GZF 294 730-613	2x M63x1.5	2x Ø32-49	2x240	M12	
355 S	3GZF 294 730-759	3GZF 294 730-301		2x Ø48-60	4x240	M12	D
	-	3GZF 294 730-301		2x Ø48-60	2x240	M12	E
355 SM_	3GZF 294 730-759	3GZF 294 730-301		2x Ø48-60	4x240	M12	
355 ML_	3GZF 294 730-759	LNPB 3328		2x Ø60-80	4x240	M12	
1500 r/min (4 poles)							
280	3GZF 294 730-749	2x 3GZF 294 730-613	2x M63x1.5	2x Ø32-49	2x150	M12	
315	3GZF 294 730-753	2x 3GZF 294 730-613	2x M63x1.5	2x Ø32-49	2x240	M12	
355 S	3GZF 294 730-759	3GZF 294 730-301		2x Ø48-60	4x240	M12	D
	-	3GZF 294 730-301		2x Ø48-60	2x240	M12	E
355 SM_	3GZF 294 730-759	3GZF 294 730-301		2x Ø48-60	4x240	M12	
355 ML_	3GZF 294 730-759	LNPB 3328		2x Ø60-80	4x240	M12	
1000 r/min (6 poles)							
280	3GZF 294 730-749	2x 3GZF 294 730-613	2x M63x1.5	2x Ø32-49	2x150	M12	
315	3GZF 294 730-753	2x 3GZF 294 730-613	2x M63x1.5	2x Ø32-49	2x240	M12	
355 S	-	3GZF 294 730-301		2x Ø48-60	2x240	M12	
355 SMB	3GZF 294 730-759	3GZF 294 730-301		2x Ø48-60	4x240	M12	D
	-	3GZF 294 730-301		2x Ø48-60	2x240	M12	E
355 MLA	3GZF 294 730-759	3GZF 294 730-301		2x Ø48-60	4x240	M12	
750 r/min (8 poles)							
280	3GZF 294 730-749	2x 3GZF 294 730-613	2x M63x1.5	2x Ø32-49	2x150	M12	
315	3GZF 294 730-753	2x 3GZF 294 730-613	2x M63x1.5	2x Ø32-49	2x240	M12	
355 S	-	3GZF 294 730-301		2x Ø48-60	2x240	M12	
355 MLA	-	3GZF 294 730-301		2x Ø48-60	2x240	M12	
355 MLC	3GZF 294 730-759	3GZF 294 730-301		2x Ø48-60	4x240	M12	D
	-	3GZF 294 730-301		2x Ø48-60	2x240	M12	E

Voltage/frequency codes:

D - 380-420 VΔ 50 Hz, 660-690 VY 50 Hz, 440-480 VΔ 60 Hz

E - 500 VΔ 50 Hz, 575 VΔ 60 Hz

Examples:

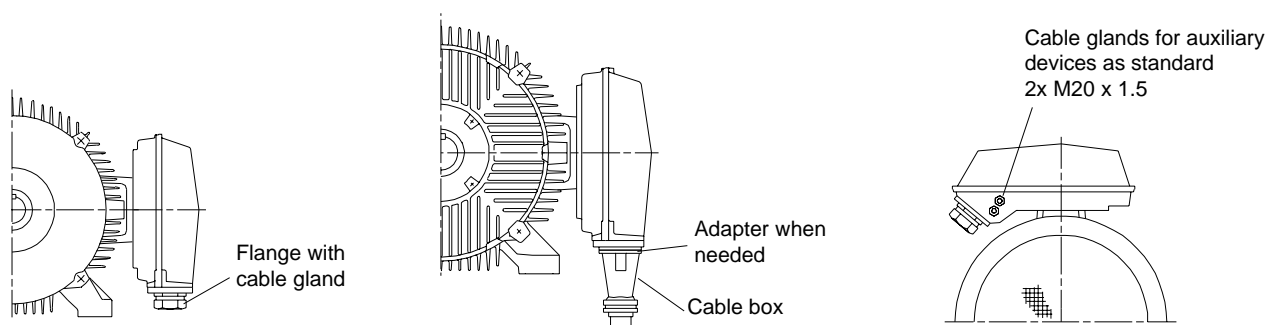

Technical data – Dust ignition proof motors

Category 2 D - T125°C - IP 65
Aluminium frame, sizes 90 to 250



IC 411; Insulation class F, temperature rise class B

Output kW	Type designation	Product code	Speed r/min	Effi- ciency %	Power factor cos φ	Current		Torque			Moment of inertia J=1/4GD ² kgm ²	Sound pressure level LP dB(A)	
						I _N A	I _s I _N	T Nm	T _s T _N	T _{max} T _N			Weight kg
3000 r/min = 2 poles													
						400 V 50 Hz¹⁾						Basic design	
1.5	M3AAD 90 S	3GAA 091 001-••A	2870	80.1	0.82	3.35	5.5	5	2.4	3.0	0.0019	13	63
2.2	M3AAD 90 L	3GAA 091 002-••A	2880	83.6	0.87	4.37	7.0	7.5	2.7	3.0	0.0024	16	63
3	M3AAD 100 L	3GAA 101 001-••A	2900	86.0	0.88	5.95	7.5	10	2.7	3.6	0.0041	21	65
4	M3AAD 112 M	3GAA 111 001-••B	2850	86.0	0.91	7.4	7.5	13.4	2.8	3.0	0.01	25	63
5.5	M3AAD 132 SA	3GAA 131 001-••B	2855	86.0	0.88	10.5	7.8	18.4	3.2	3.4	0.014	37	75
7.5	M3AAD 132 SB	3GAA 131 002-••B	2860	88.0	0.89	13.9	8.5	25.1	3.4	3.6	0.016	42	73
11	M3AAD 160 MA	3GAA 161 101-••D	2930	91.2	0.88	20	6.3	36	1.9	2.5	0.039	73	69
15	M3AAD 160 M	3GAA 161 102-••D	2920	91.7	0.90	26.5	6.6	49	2.3	2.5	0.047	84	69
18.5	M3AAD 160 L	3GAA 161 103-••D	2920	92.4	0.91	32	7.3	60	2.6	2.7	0.053	94	69
22	M3AAD 180 M	3GAA 181 101-••D	2930	92.8	0.89	38.5	7.2	71	2.5	2.7	0.077	119	69
30	MBT 200 LA	AC 616 005-••	2945	91.1	0.89	53	6.5	97	2.6	3.0	0.142	172	75
37	MBT 200 L	AC 616 006-••	2950	92.6	0.90	64	7.8	120	2.9	3.2	0.17	195	75
45	MBT 225 M	AC 616 007-••	2950	92.1	0.89	79	7.1	146	2.2	3.1	0.284	225	75
55	MBT 250 M	AC 616 008-••	2950	93.1	0.90	95	7.6	178	2.3	3.7	0.345	320	75
3000 r/min = 2 poles													
						400 V 50 Hz¹⁾						High-output design	
4 ²⁾	M3AAD 100 LB	3GAA 101 002-••A	2900	85.0	0.86	8.1	7.5	13	2.7	3.6	0.005	25	68
5.5 ²⁾	M3AAD 112 MB	3GAA 111 002-••B	2855	86.5	0.93	9.9	7.3	18.4	2.7	2.9	0.012	33	66
9.2 ²⁾	M3AAD 132 SBB	3GAA 131 004-••B	2825	86.0	0.93	16.6	7.3	31.1	3.2	3.5	0.022	57	74
11 ²⁾	M3AAD 132 SC	3GAA 131 003-••B	2835	87.0	0.93	19.6	8.0	37	3.2	3.3	0.022	57	73
30 ²⁾	M3AAD 180 LB	3GAA 181 102-••D	2945	93.7	0.89	53	8.3	97	3.1	3.4	0.092	137	70
1500 r/min = 4 poles													
						400 V 50 Hz¹⁾						Basic design	
1.1	M3AAD 90 S	3GAA 092 001-••A	1410	77.5	0.81	2.59	5.0	7.5	2.2	2.7	0.0032	13	50
1.5	M3AAD 90 L	3GAA 092 002-••A	1420	80.3	0.79	3.45	5.0	10	2.4	2.9	0.0043	16	50
2.2	M3AAD 100 LA	3GAA 102 001-••A	1430	83.0	0.81	4.8	5.5	15	2.4	2.9	0.0069	21	64
3	M3AAD 100 LB	3GAA 102 002-••A	1430	85.0	0.81	6.48	5.5	20	2.5	2.9	0.0082	24	66
4	M3AAD 112 M	3GAA 112 001-••B	1435	84.5	0.80	8.6	7.0	26.6	2.9	3.1	0.015	27	60
5.5	M3AAD 132 S	3GAA 132 001-••B	1450	87.0	0.83	11.1	7.3	36.2	2.2	3.0	0.031	40	66
7.5	M3AAD 132 M	3GAA 132 002-••B	1450	88.0	0.83	14.8	7.9	49.4	2.5	3.2	0.038	48	66
11	M3AAD 160 M	3GAA 162 101-••D	1460	90.3	0.81	21.5	6.7	72	2.9	2.8	0.067	75	62
15	M3AAD 160 L	3GAA 162 102-••D	1465	91.8	0.80	30	6.8	97	2.9	3.3	0.091	94	62
18.5	M3AAD 180 M	3GAA 182 101-••D	1470	92.3	0.84	35	7.0	120	3.1	2.7	0.161	124	62
22	M3AAD 180 L	3GAA 182 102-••D	1470	92.6	0.83	41	7.0	143	2.9	2.8	0.191	141	63
30	MBT 200 L	AC 616 013-••	1480	91.7	0.82	57	7.6	194	2.6	2.9	0.31	192	68
37	MBT 225 S	AC 616 014-••	1485	93.2	0.82	70	6.8	238	2.7	2.7	0.405	225	70
45	MBT 225 M	AC 616 015-••	1485	93.7	0.83	83	7.3	289	2.8	2.9	0.495	250	70
55	MBT 250 M	AC 616 016-••	1485	93.7	0.82	103	7.0	354	2.7	3.0	0.567	320	70
1500 r/min = 4 poles													
						400 V 50 Hz¹⁾						High-output design	
1.85 ²⁾	M3AAD 90 L	3GAA 092 003-••A	1390	79.5	0.80	4.4	4.5	13	2.2	2.4	0.0043	16	50
2.2 ²⁾	M3AAD 90 LB	3GAA 092 004-••A	1390	80.3	0.83	4.85	4.5	15	2.2	2.4	0.0048	17	50
4 ²⁾	M3AAD 100 LC	3GAA 102 003-••A	1420	81.0	0.82	8.65	5.5	27	2.5	2.8	0.009	25	60
5.5 ²⁾	M3AAD 112 MB	3GAA 112 002-••B	1425	84.5	0.83	11.4	7.1	36.9	2.8	3.1	0.018	34	60
9.2 ²⁾	M3AAD 132 MBA	3GAA 132 004-••B	1450	88.0	0.85	17.8	7.3	60	2.0	2.8	0.048	59	63
11 ²⁾	M3AAD 132 MB	3GAA 132 003-••B	1450	88.0	0.86	21	8.3	72	2.5	2.7	0.048	59	66

¹⁾ Motors are certified for the voltages 380-400 V 50 Hz according to IEC 60034-1. Values above are given for 400 V 50 Hz; data for any voltages < 500 V on request.

²⁾ Temperature rise class F.

During the transition period some motor types belonging to M3000 range still have the old product codes and type designations. Always check the valid code before ordering.

Notes:

When ordering motors, variant code 453 'DIP according to EN 50281-1-1, T= 125°C, category 2 D, IP 65' has to be added.

Data for other voltages and frequencies, on request.

The two bullets in the product code indicate choice of mounting arrangement (see ordering information), voltage and frequency (below).

S	D	E	F	G	H	X
380-400 VY 50 Hz	380-400 VΔ 50 Hz	500 V Δ 50 Hz	500 VY 50 Hz	415 VY 50 Hz	415 VΔ 50 Hz	Other rated voltage, connection or frequency, max. 500 V
220-230 VΔ 50 Hz	440-460 VΔ 60 Hz					
440-460 VY 60 Hz						

Technical data – Dust ignition proof motors

Category 2 D - T125°C - IP 65
Aluminium frame, sizes 90 to 250



IC 411; Insulation class F, temperature rise class B

Output kW	Type designation	Product code	Speed r/min	Efficiency %	Power factor cos φ	Current		Torque			Moment of inertia J=1/4GD ² kgm ²	Weight kg	Sound pressure level LP dB(A)
						I _N A	I _s /I _N	T Nm	T _s /T _N	T _{max} /T _N			
1000 r/min = 6 poles													
400 V 50 Hz¹⁾													
Basic design													
0.75	M3AAD 90 S	3GAA 093 001-••A	930	71.5	0.67	2.36	4.0	7.5	1.9	2.3	0.0032	13	44
1.1	M3AAD 90 L	3GAA 093 002-••A	930	74.4	0.69	3.25	4.0	11	1.9	2.3	0.0043	16	44
1.5	M3AAD 100 L	3GAA 103 001-••A	950	80.0	0.71	3.92	4.5	15	1.9	2.3	0.0082	23	49
2.2	M3AAD 112 M	3GAA 113 001-••B	940	80.5	0.74	5.4	5.6	22.3	2.1	2.7	0.015	27	66
3	M3AAD 132 S	3GAA 133 001-••B	960	84.5	0.75	6.9	6.1	29.8	2.0	2.6	0.031	39	57
4	M3AAD 132 MA	3GAA 133 002-••B	960	85.5	0.78	8.7	7.1	39.7	2.0	2.8	0.038	46	61
5.5	M3AAD 132 MB	3GAA 133 003-••B	955	86.0	0.78	11.9	6.9	55	2.2	2.8	0.045	54	57
7.5	M3AAD 160 M	3GAA 163 101-••D	970	89.3	0.79	15.4	6.7	74	2.0	2.8	0.089	88	59
11	M3AAD 160 L	3GAA 163 102-••D	970	89.8	0.78	23	7.1	109	2.2	2.9	0.107	102	59
15	M3AAD 180 L	3GAA 183 101-••D	970	90.8	0.78	31	7.0	148	2.1	3.0	0.217	151	59
18.5	MBT 200 LA	AC 616 020-••	980	89.5	0.80	37	6.4	180	2.1	3.0	0.315	192	68
22	MBT 200 L	AC 616 021-••	980	89.5	0.80	45	7.4	214	2.3	3.1	0.34	202	68
30	MBT 225 M	AC 616 022-••	985	91.5	0.83	57	6.5	291	1.7	3.1	0.766	235	68
37	MBT 250 M	AC 616 023-••	985	92.0	0.82	71	6.5	359	1.9	3.3	0.88	330	69
1000 r/min = 6 poles													
400 V 50 Hz¹⁾													
High-output design													
2.2 ²⁾	M3AAD 100 LC	3GAA 103 002-••A	940	77.0	0.71	5.9	4.5	22	1.9	2.3	0.009	26	49
6.5 ²⁾	M3AAD 132 MC	3GAA 133 004-••B	960	85.0	0.75	14.8	6.6	64	2.0	2.7	0.049	59	61
14 ²⁾	M3AAD 160 LB	3GAA 163 103-••D	960	89.1	0.77	29.5	7.6	139	2.7	3.1	0.127	117	62
18.5 ²⁾	M3AAD 180 LB	3GAA 183 102-••D	965	90.6	0.79	37.5	6.2	183	2.0	2.6	0.237	160	59
750 r/min = 8 poles													
400 V 50 Hz¹⁾													
Basic design													
0.37	M3AAD 90 S	3GAA 094 001-••A	700	61.5	0.56	1.6	3.0	5	1.9	2.4	0.0032	13	43
0.55	M3AAD 90 L	3GAA 094 002-••A	690	62.9	0.57	2.35	3.0	7.5	1.7	2.1	0.0043	16	43
0.75	M3AAD 100 LA	3GAA 104 001-••A	700	72.0	0.59	2.55	3.5	10	2.1	2.7	0.0069	20	46
1.1	M3AAD 100 LB	3GAA 104 002-••A	700	73.0	0.64	3.35	3.5	15	2.1	2.7	0.0082	23	46
1.5	M3AAD 112 M	3GAA 114 001-••B	695	74.5	0.65	4.5	4.1	20.6	1.9	2.4	0.016	28	52
2.2	M3AAD 132 S	3GAA 134 001-••B	720	80.5	0.67	5.9	5.3	29.2	1.6	2.5	0.038	46	56
3	M3AAD 132 M	3GAA 134 002-••B	720	82.0	0.68	7.8	5.5	39.8	1.8	2.5	0.045	53	56
4	M3AAD 160 MA	3GAA 164 101-••D	715	84.1	0.69	10	5.2	54	2.1	2.4	0.072	75	59
5.5	M3AAD 160 M	3GAA 164 102-••D	710	84.7	0.70	13.4	5.4	74	2.4	2.6	0.091	88	59
7.5	M3AAD 160 L	3GAA 164 103-••D	715	86.3	0.70	18.1	5.4	100	2.4	2.8	0.131	118	59
11	M3AAD 180 L	3GAA 184 101-••D	720	88.7	0.76	23.5	5.9	146	2.4	2.6	0.224	147	59
15	MBT 200 L	AC 616 028-••	730	85.6	0.75	34	5.7	196	2.0	3.0	0.314	187	64
18.5	MBT 225 S	AC 616 029-••	730	88.1	0.78	39	5.3	242	2.1	2.4	0.587	215	65
22	MBT 225 M	AC 616 030-••	735	89.1	0.77	46	5.6	286	2.2	2.7	0.722	235	65
30	MBT 250 M	AC 616 031-••	735	89.6	0.74	65	5.9	390	2.5	3.0	0.83	330	65
750 r/min = 8 poles													
400 V 50 Hz¹⁾													
High-output design													
3.8 ²⁾	M3AAD 132 MB	3GAA 134 003-••B	710	80.5	0.69	9.9	5.2	51	1.8	2.3	0.049	59	56

¹⁾ Motors are certified for the voltages 380-400 V 50 Hz according to IEC 60034-1. Values above are given for 400 V 50 Hz; data for any voltages < 500 V on request.

²⁾ Temperature rise class F.

During the transition period some motor types belonging to M3000 range still have the old product codes and type designations. Always check the valid code before ordering.

Notes:

When ordering motors, variant code 453 'DIP according to EN 50281-1-1, T= 125°C, category 2 D, IP 65' has to be added.

Data for other voltages and frequencies, on request.

The two bullets in the product code indicate choice of mounting arrangement (see ordering information), voltage and frequency (below).

S	D	E	F	G	H	X
380-400 VY 50 Hz	380-400 VΔ 50 Hz	500 VΔ 50 Hz	500 VY 50 Hz	415 VY 50 Hz	415 VΔ 50 Hz	Other rated voltage, connection or frequency, max. 500 V
220-230 VΔ 50 Hz	440-460 VΔ 60 Hz					
440-460 VY 60 Hz						

Technical data – Dust ignition proof motors

Category 2 D - T125°C - IP 65
Cast iron frame, sizes 80 to 315



IC 411; Insulation class F, temperature rise class B

Output kW	Type designation	Product code	Speed r/min	Effi- ciency %	Power factor cos φ	Current		Torque			Moment of inertia J=1/4GD ² kgm ²	Weight kg	Sound pressure level LP dB(A)
						I _N A	I _s I _N	T Nm	T _s T _N	T _{max} T _N			
3000 r/min = 2 poles			400 V 50 Hz ¹⁾					Basic design					
0.75	M2BA 80 LS	3GBA 081 310-••E	2905	76.0	0.80	2.2	8.4	2.5	3.5	4.0	0.0009	24	59
1.1	M2BA 80 L	3GBA 081 320-••E	2850	78.3	0.82	2.5	6.4	3.7	2.5	2.7	0.0009	24	59
1.5	M2BA 90 S	3GBA 091 110-••E	2880	80.6	0.85	3.3	6.6	5	2.3	2.7	0.0019	32	65
2.2	M2BA 90 L	3GBA 091 510-••E	2880	83.0	0.88	4.6	7.0	7.3	2.5	3.2	0.0024	37	65
3	M2BA 100 L	3GBA 101 510-••E	2910	84.5	0.88	5.9	7.6	9.8	2.6	2.9	0.0041	45	66
4	M2BA 112 M	3GBA 111 310-••E	2875	84.5	0.91	7.4	7.2	13.2	2.3	3.0	0.005	46	67
5.5	M2BA 132 SA	3GBA 131 110-••E	2855	85.4	0.89	10.5	7.9	18.4	3.2	3.5	0.014	69	69
7	M2BA 132 SB	3GBA 131 120-••E	2875	87.2	0.89	13.2	7.8	23	3.3	3.5	0.016	79	69
11	M3GP 160 MLA	3GGP 161 410-••G	2936	91.2	0.87	20	7.2	36	2.9	3.3	0.039	147	71
15	M3GP 160 MLB	3GGP 161 420-••G	2934	91.6	0.88	28	7.5	49	3.1	3.5	0.047	156	71
18.5	M3GP 160 MLC	3GGP 161 430-••G	2934	92.4	0.90	33	7.5	60	2.8	3.4	0.054	167	71
22	M3GP 180 MLA	3GGP 181 410-••G	2938	92.6	0.90	39	6.9	72	2.5	3.1	0.077	194	71
30	M3GP 200 MLA	3GGP 201 410-••G	2946	94.0	0.88	54	7.4	97	3.0	3.2	0.15	275	74
37	M3GP 200 MLC	3GGP 201 430-••G	2948	94.1	0.89	65	7.6	120	2.9	3.2	0.19	305	77
45	M3GP 225 SMB	3GGP 221 220-••G	2968	94.7	0.87	79	7.2	145	2.7	3.0	0.26	365	76
55	M3GP 250 SMA	3GGP 251 210-••G	2970	94.6	0.88	96	7.7	177	2.4	3.1	0.49	425	75
75	M3GP 280 SMA	3GGP 281 210-••G	2978	94.8	0.88	131	7.6	240	2.1	3.0	0.8	625	77
90	M3GP 280 SMB	3GGP 281 220-••G	2976	95.1	0.90	152	7.4	289	2.1	2.9	0.9	665	77
110	M3GP 315 SMA	3GGP 311 210-••G	2982	95.1	0.86	194	7.6	352	2.0	3.0	1.2	880	78
132	M3GP 315 SMB	3GGP 311 220-••G	2982	95.4	0.88	228	7.4	423	2.2	3.0	1.4	940	78
160	M3GP 315 SMC	3GGP 311 230-••G	2981	96.1	0.89	269	7.5	513	2.3	3.0	1.7	1025	78
200	M3GP 315 MLA	3GGP 311 410-••G	2980	96.3	0.90	336	7.7	641	2.6	3.0	2.1	1190	78
3000 r/min = 2 poles			400 V 50 Hz ¹⁾					High-output design					
22	M3GP 160 MLD	3GGP 161 440-••G	2929	91.4	0.90	39	7.4	72	2.8	3.4	0.059	173	77
30	M3GP 180 MLB	3GGP 181 420-••G	2944	92.8	0.88	54	7.5	97	2.8	3.5	0.092	210	78
55	M3GP 225 SMC	3GGP 221 230-••G	2965	94.3	0.88	96	7.1	177	2.6	3.0	0.29	385	80
75	M3GP 250 SMB	3GGP 251 220-••G	2969	95.1	0.89	129	7.9	241	2.6	3.2	0.57	465	80
110	M3GP 280 SMC	3GGP 281 230-••G	2978	95.7	0.90	185	7.9	353	2.4	3.0	1.15	725	77

¹⁾ Motors are certified for the voltages 380-400-415 V 50 Hz according to IEC 60034-1.
Values above are given for 400 V 50 Hz; data for other voltages on request.

Notes:

- When ordering motors, variant code 453 'DIP according to EN 50281-1-1, T= 125°C, category 2 D, IP 65' has to be added.
- When ordering sizes 160-200 with lifetime lubrication, variant code 194 '2Z-bearings at both ends' has to be added.

Data for other voltages and frequencies, on request.

The two bullets in the product code indicate choice of mounting arrangement (see ordering information), voltage and frequency (below).

S	D	A ¹⁾	B ¹⁾	E	F	X
380 VY 50 Hz	380 VΔ 50 Hz	380 VY 50 Hz	380 VΔ 50 Hz	500 VΔ 50 Hz	500 VY 50 Hz	Other rated voltage, connection or frequency, max. 690 V
400 VY 50 Hz	400 VΔ 50 Hz	220 VΔ 50 Hz	660 VY 50 Hz	575 VΔ 60 Hz		
415 VY 50 Hz	415 VΔ 50 Hz					
220 VΔ 50 Hz	660 VY 50 Hz	G ¹⁾	H ¹⁾	T	U	
230 VΔ 50 Hz	690 VY 50 Hz	415 VY 50 Hz	415 VΔ 50 Hz	660 VΔ 50 Hz	690 VΔ 50 Hz	
440 VY 60 Hz	440 VΔ 60 Hz					

¹⁾ On request for motor sizes 315.

Technical data – Dust ignition proof motors

Category 2 D - T125°C - IP 65
Cast iron frame, sizes 80 to 355



IC 411; Insulation class F, temperature rise class B

Output kW	Type designation	Product code	Speed r/min	Effi- ciency %	Power factor cos φ	Current		Torque			Moment of inertia J=1/4GD ² kgm ²	Weight kg	Sound pressure level LP dB(A)
						I _N A	I _s I _N	T Nm	T _s T _N	T _{max} T _N			
1500 r/min = 4 poles			400 V 50 Hz ¹⁾						Basic design				
0.55	M2BA 80 LS	3GBA 082 310-••E	1450	76.6	0.62	1.6	6.5	3.6	3.9	3.9	0.002	24	45
0.75	M2BA 80 L	3GBA 082 320-••E	1415	76.8	0.70	2	5.6	5	2.8	2.8	0.002	24	45
1.1	M2BA 90 S	3GBA 092 110-••E	1420	77.8	0.79	2.6	4.7	7.4	2.0	2.5	0.0032	32	54
1.5	M2BA 90 L	3GBA 092 510-••E	1420	79.8	0.78	3.5	5.5	10.1	2.5	2.9	0.0043	36	54
2.2	M2BA 100 LA	3GBA 102 510-••E	1435	81.6	0.81	4.8	6.3	14.6	2.4	2.4	0.0069	44	52
3	M2BA 100 LB	3GBA 102 520-••E	1435	83.6	0.80	6.5	6.3	20	2.5	2.7	0.0082	47	52
4	M2BA 112 M	3GBA 112 310-••E	1440	83.4	0.77	9.1	6.4	27	3.0	3.3	0.01	51	60
5.5	M2BA 132 S	3GBA 132 110-••E	1450	86.8	0.83	11.1	7.3	36.1	2.2	3.0	0.031	79	60
7.5	M2BA 132 MB	3GBA 132 320-••E	1450	87.3	0.83	14.8	8.1	49.3	2.9	3.3	0.048	93	60
11	M3GP 160 MLC	3GGP 162 430-••G	1470	91.3	0.82	22.5	7.7	71	3.1	3.6	0.09	166	62
15	M3GP 160 MLE	3GGP 162 450-••G	1467	92.0	0.83	30	7.6	98	3.1	3.6	0.121	189	67
18.5	M3GP 180 MLA	3GGP 182 410-••G	1474	92.5	0.82	36	7.3	120	2.7	3.2	0.176	206	62
22	M3GP 180 MLB	3GGP 182 420-••G	1471	92.6	0.82	42	7.1	143	2.6	3.0	0.191	214	62
30	M3GP 200 MLB	3GGP 202 420-••G	1475	93.5	0.84	56	7.4	194	3.3	3.0	0.34	305	61
37	M3GP 225 SMB	3GGP 222 220-••G	1480	93.6	0.84	69	7.7	239	3.1	3.1	0.42	355	67
45	M3GP 225 SMC	3GGP 222 230-••G	1477	94.4	0.86	81	7.4	291	3.1	3.0	0.49	390	67
55	M3GP 250 SMA	3GGP 252 210-••G	1479	94.6	0.83	101	6.9	355	2.5	3.1	0.72	415	66
75	M3GP 280 SMA	3GGP 282 210-••G	1484	94.9	0.85	135	6.9	483	2.5	2.8	1.25	625	68
90	M3GP 280 SMB	3GGP 282 220-••G	1483	95.2	0.86	159	7.2	580	2.5	2.7	1.5	665	68
110	M3GP 315 SMA	3GGP 312 210-••G	1487	95.6	0.86	193	7.2	706	2.0	2.5	2.3	900	70
132	M3GP 315 SMB	3GGP 312 220-••G	1487	95.8	0.86	232	7.1	848	2.3	2.7	2.6	960	70
160	M3GP 315 SMC	3GGP 312 230-••G	1487	96.0	0.85	287	7.2	1028	2.4	2.9	2.9	1000	70
200	M3GP 315 MLA	3GGP 312 410-••G	1486	96.2	0.86	351	7.2	1285	2.5	2.9	3.5	1160	70
250	M2BA 355 S	3GBA 352 100-••A	1487	96.5	0.87	430	7.2	1606	2.3	2.7	6.5	1550	80
315	M2BA 355 SMA	3GBA 352 210-••A	1488	96.7	0.87	545	7.6	2022	2.5	2.9	8.2	1800	80
345	M2BA 355 SMB	3GBA 352 220-••A	1486	96.7	0.87	590	7.0	2217	2.3	2.7	8.2	1800	80
400	M2BA 355 MLA	3GBA 352 410-••A	1489	96.8	0.87	685	6.9	2565	1.6	2.8	10	2100	80
500	M2BA 355 MLC	3GBA 352 430-••A	1489	96.8	0.88	845	7.6	3207	1.3	2.9	10.5	2100	83

1500 r/min = 4 poles			400 V 50 Hz ¹⁾						High-output design				
18.5	M3GP 160 MLF	3GGP 162 460-••G	1466	92.0	0.82	36.5	8.0	120	3.2	3.6	0.121	189	68
30 ²⁾	M3GP 180 MLC	3GGP 182 430-••G	1473	92.3	0.80	59	7.8	194	3.1	3.4	0.239	233	66
37	M3GP 200 MLC	3GGP 202 430-••G	1475	93.3	0.82	70	7.5	239	3.5	3.2	0.34	305	73
55	M3GP 225 SMD	3GGP 222 240-••G	1476	94.0	0.85	100	7.6	356	3.3	3.1	0.49	390	74
75	M3GP 250 SMB	3GGP 252 220-••G	1476	94.7	0.86	133	7.2	485	2.7	3.2	0.88	470	73
110	M3GP 280 SMC	3GGP 282 230-••G	1485	95.6	0.86	195	7.6	707	3.0	3.0	1.85	725	68

¹⁾ Motors are certified for the voltages 380-400-415 V 50 Hz according to IEC 60034-1. Values above are given for 400 V 50 Hz; data for other voltages on request.

²⁾ Temperature rise class F.

ATEX certification process ongoing for frame size 355.

Notes:

- When ordering motors, variant code 453 'DIP according to EN 50281-1-1, T= 125°C, category 2 D, IP 65' has to be added.
- When ordering sizes 160-200 with lifetime lubrication, variant code 194 'ZZ-bearings at both ends' has to be added.

Data for other voltages and frequencies, on request.

The two bullets in the product code indicate choice of mounting arrangement (see ordering information), voltage and frequency (below).

S	D	A ¹⁾	B ¹⁾	E	F ²⁾	X
380 VY 50 Hz	380 VΔ 50 Hz	380 VY 50 Hz	380 VΔ 50 Hz	500 VΔ 50 Hz	500 VY 50 Hz	Other rated voltage, connection or frequency, max. 690 V
400 VY 50 Hz	400 VΔ 50 Hz	220 VΔ 50 Hz	660 VY 50 Hz	575 VΔ 60 Hz		
415 VY 50 Hz	415 VΔ 50 Hz					
220 VΔ 50 Hz	660 VY 50 Hz	G ¹⁾	H ¹⁾	T ²⁾	U ²⁾	
230 VΔ 50 Hz	690 VY 50 Hz	415 VY 50 Hz	415 VΔ 50 Hz	660 VΔ 50 Hz	690 VΔ 50 Hz	
440 VY 60 Hz	440 VΔ 60 Hz					

¹⁾ On request for motor sizes 315-355.

²⁾ On request for motor sizes 355.

Technical data – Dust ignition proof motors

Category 2 D - T125°C - IP 65
Cast iron frame, sizes 80 to 355



IC 411; Insulation class F, temperature rise class B

Output kW	Type designation	Product code	Speed r/min	Effi- ciency %	Power factor cos φ	Current		Torque			Moment of inertia J=1/4GD ² kgm ²	Weight kg	Sound pressure level LP dB(A)
						I _N A	I _s I _N	T Nm	T _s T _N	T _{max} T _N			
1000 r/min = 6 poles			400 V 50 Hz ¹⁾					Basic design					
0.37	M2BA 80 LS	3GBA 083 310-••E	950	67.2	0.50	1.6	4.2	3.7	4.3	4.5	0.002	24	42
0.55	M2BA 80 L	3GBA 083 320-••E	910	66.5	0.62	1.8	3.7	5.7	2.8	3.0	0.002	24	42
0.75	M2BA 90 S	3GBA 093 110-••E	930	71.7	0.66	2.3	3.7	7.7	2.0	2.3	0.0032	32	44
1.1	M2BA 90 L	3GBA 093 510-••E	930	72.2	0.66	2.8	3.9	11.3	2.2	2.6	0.0043	37	44
1.5	M2BA 100 L	3GBA 103 510-••E	950	78.4	0.71	4.1	4.8	15.1	2.1	2.6	0.0082	47	47
2.2	M2BA 112 M	3GBA 113 310-••E	950	79.4	0.70	5.7	4.8	22.1	2.5	2.8	0.01	51	50
3	M2BA 132 S	3GBA 133 110-••E	960	83.6	0.75	6.9	6.1	29.8	2.4	2.6	0.031	79	61
4	M2BA 132 MA	3GBA 133 310-••E	955	84.8	0.78	8.7	7.1	40	2.6	2.8	0.038	82	61
5.5	M2BA 132 MC	3GBA 133 330-••E	955	85.0	0.78	11	7.0	55	2.8	2.8	0.045	99	61
7.5	M3GP 160 MLA	3GGP 163 410-••G	965	88.6	0.80	15.5	6.5	74	1.9	3.0	0.088	160	57
11	M3GP 160 MLB	3GGP 163 420-••G	965	89.2	0.79	23	7.1	109	2.1	3.3	0.106	173	65
15	M3GP 180 MLB	3GGP 183 420-••G	972	91.1	0.80	31	7.0	147	1.9	3.3	0.221	233	67
18.5	M3GP 200 MLA	3GGP 203 410-••G	983	91.3	0.80	37	7.1	180	3.2	3.1	0.37	265	66
22	M3GP 200 MLB	3GGP 203 420-••G	983	91.6	0.81	43	7.5	214	3.2	3.2	0.43	285	61
30	M3GP 225 SMB	3GGP 223 220-••G	985	92.8	0.81	58	7.4	291	3.4	3.0	0.64	350	61
37	M3GP 250 SMA	3GGP 253 210-••G	987	93.4	0.81	71	7.2	358	3.2	2.9	1.16	420	66
45	M3GP 280 SMA	3GGP 283 210-••G	990	94.4	0.84	82	7.0	434	2.5	2.5	1.85	605	66
55	M3GP 280 SMB	3GGP 283 220-••G	990	94.6	0.84	101	7.0	531	2.7	2.6	2.2	645	66
75	M3GP 315 SMA	3GGP 313 210-••G	992	95.0	0.82	141	7.4	722	2.4	2.8	3.2	830	70
90	M3GP 315 SMB	3GGP 313 220-••G	992	95.5	0.84	163	7.5	866	2.4	2.8	4.1	930	70
110	M3GP 315 SMC	3GGP 313 230-••G	991	95.6	0.83	202	7.4	1060	2.5	2.9	4.9	1000	70
132	M3GP 315 MLA	3GGP 313 410-••G	991	95.8	0.83	240	7.5	1272	2.7	3.0	5.8	1150	68
160	M2BA 355 S	3GBA 353 100-••A	992	95.9	0.85	280	6.8	1540	1.8	2.7	10.4	1500	75
200	M2BA 355 SMA	3GBA 353 210-••A	992	95.9	0.85	355	7.1	1925	2.0	2.7	12.5	1800	75
250	M2BA 355 SMB	3GBA 353 220-••A	992	96.0	0.84	450	7.5	2407	2.2	2.8	12.5	1800	75
305	M2BA 355 MLA	3GBA 353 410-••A	991	96.2	0.84	550	7.5	2940	2.1	3.1	14.6	2100	75
355	M2BA 355 MLC	3GBA 353 430-••A	991	96.4	0.84	635	7.6	3421	1.5	3.0	15.8	2100	78
1000 r/min = 6 poles			400 V 50 Hz ¹⁾					High-output design					
14 ²⁾	M3GP 160 MLC	3GGP 163 430-••G	969	88.9	0.74	31	7.9	138	2.8	3.9	0.121	188	64
30	M3GP 200 MLC	3GGP 203 430-••G	983	91.6	0.80	60	7.5	292	3.5	3.4	0.49	305	65
37	M3GP 225 SMC	3GGP 223 230-••G	983	92.8	0.83	70	7.1	359	3.2	2.8	0.75	380	64
45	M3GP 250 SMB	3GGP 253 220-••G	986	93.7	0.82	85	7.2	436	3.3	2.8	1.49	465	65
75	M3GP 280 SMC	3GGP 283 230-••G	990	95.1	0.84	137	7.3	723	2.8	2.7	2.85	725	66

¹⁾ Motors are certified for the voltages 380-400-415 V 50 Hz according to IEC 60034-1.
Values above are given for 400 V 50 Hz; data for other voltages on request.

²⁾ Temperature rise class F.

ATEX certification process ongoing for frame size 355.

Notes:

- When ordering motors, variant code 453 'DIP according to EN 50281-1-1, T= 125°C, category 2 D, IP 65' has to be added.
- When ordering sizes 160-200 with lifetime lubrication, variant code 195 'Bearings greased for life' has to be added.

Data for other voltages and frequencies, on request.

Technical data – Dust ignition proof motors

Category 2 D - T125°C - IP 65
Cast iron frame, sizes 80 to 355



IC 411; Insulation class F, temperature rise class B

Output kW	Type designation	Product code	Speed r/min	Efficiency %	Power factor cos φ	Current		Torque			Moment of inertia J=1/4GD ² kgm ²	Weight kg	Sound pressure level LP dB(A)
						I _N A	I _s /I _N	T Nm	T _s /T _N	T _{max} /T _N			
750 r/min = 8 poles			400 V 50 Hz ¹⁾					Basic design					
0.18	M2BA 80 LS	3GBA 084 310-••E	700	52.6	0.47	1.1	3.4	2.5	3.5	3.2	0.002	24	36
0.25	M2BA 80 L	3GBA 084 320-••E	690	57.5	0.56	1.3	3.2	3.5	2.5	2.3	0.002	24	36
0.37	M2BA 90 S	3GBA 094 110-••E	700	61.0	0.55	1.6	3.0	5	1.9	2.5	0.0031	32	36
0.55	M2BA 90 L	3GBA 094 510-••E	695	62.7	0.54	2.4	3.0	7.6	1.9	2.4	0.0047	37	36
0.75	M2BA 100 LA	3GBA 104 510-••E	715	71.7	0.57	2.8	3.6	10.1	2.3	3.0	0.0069	44	44
1.1	M2BA 100 LB	3GBA 104 520-••E	705	71.7	0.61	3.7	3.6	15	2.1	2.6	0.0083	47	44
1.5	M2BA 112 M	3GBA 114 310-••E	705	72.5	0.58	4.3	4.3	20	2.7	3.0	0.01	51	46
2.2	M2BA 132 S	3GBA 134 110-••E	720	79.5	0.68	5.9	5.3	29.2	1.8	2.5	0.038	82	56
3	M2BA 132 M	3GBA 134 310-••E	715	79.2	0.70	7.8	5.5	39.8	2.4	2.6	0.045	99	56
4	M3GP 160 MLA	3GGP 164 410-••G	717	83.0	0.70	10.1	5.2	53	1.8	2.8	0.071	146	59
5.5	M3GP 160 MLB	3GGP 164 420-••G	715	84.1	0.70	13.9	5.2	73	1.9	2.8	0.09	160	53
7.5	M3GP 160 MLC	3GGP 164 430-••G	718	86.4	0.69	18.4	5.7	100	2.1	3.1	0.121	188	55
11	M3GP 180 MLB	3GGP 184 420-••G	724	89.9	0.72	24.5	5.7	145	1.7	2.7	0.239	227	63
15	M3GP 200 MLA	3GGP 204 410-••G	734	90.4	0.78	31	7.0	195	2.4	3.2	0.45	280	56
18.5	M3GP 225 SMA	3GGP 224 210-••G	734	90.5	0.73	41	6.1	241	2.2	3.0	0.61	335	55
22	M3GP 225 SMB	3GGP 224 220-••G	732	90.7	0.76	46	6.5	287	2.2	2.9	0.68	350	56
30	M3GP 250 SMA	3GGP 254 210-••G	735	92.0	0.78	61	6.7	390	2.0	2.9	1.25	420	56
37	M3GP 280 SMA	3GGP 284 210-••G	741	93.4	0.78	74	7.3	477	1.7	3.0	1.85	605	65
45	M3GP 280 SMB	3GGP 284 220-••G	741	94.0	0.78	90	7.6	580	1.8	3.1	2.2	645	65
55	M3GP 315 SMA	3GGP 314 210-••G	742	94.1	0.81	104	7.1	708	1.6	2.7	3.2	830	62
75	M3GP 315 SMB	3GGP 314 220-••G	741	94.4	0.82	141	7.1	968	1.7	2.7	4.1	930	62
90	M3GP 315 SMC	3GGP 314 230-••G	741	94.8	0.82	167	7.4	1161	1.8	2.7	4.9	1000	64
110	M3GP 315 MLA	3GGP 314 410-••G	740	95.0	0.83	203	7.3	1420	1.8	2.7	5.8	1150	72
750 r/min = 8 poles			400 V 50 Hz ¹⁾					High-output design					
18.5	M3GP 200 MLB	3GGP 204 420-••G	734	90.3	0.79	37.5	6.9	241	2.2	3.2	0.54	300	57
30 ²⁾	M3GP 225 SMC	3GGP 224 230-••G	731	90.3	0.76	63	6.3	392	2.3	3.0	0.75	375	59
37	M3GP 250 SMB	3GGP 254 220-••G	737	92.8	0.77	75	7.5	479	2.3	3.4	1.52	465	65
55	M3GP 280 SMC	3GGP 284 230-••G	741	94.4	0.80	105	7.9	709	1.9	3.1	2.85	725	65

¹⁾ Motors are certified for the voltages 380-400-415 V 50 Hz according to IEC 60034-1. Values above are given for 400 V 50 Hz; data for other motors voltages on request.

²⁾ Temperature rise class F.

Notes:

- When ordering motors, variant code 453 'DIP according to EN 50281-1-1, T= 125°C, category 2 D, IP 65' has to be added.
- When ordering sizes 160-200 with lifetime lubrication, variant code 194 'ZZ-bearings at both ends' has to be added.

Data for other voltages and frequencies, on request.

The two bullets in the product code indicate choice of mounting arrangement (see ordering information), voltage and frequency (below).

S	D	A ¹⁾	B ¹⁾	E	F	X
380 VY 50 Hz	380 VΔ 50 Hz	380 VY 50 Hz	380 VΔ 50 Hz	500 VΔ 50 Hz	500 VY 50 Hz	Other rated voltage, connection or frequency, max. 690 V
400 VY 50 Hz	400 VΔ 50 Hz	220 VΔ 50 Hz	660 VY 50 Hz	575 VΔ 60 Hz		
415 VY 50 Hz	415 VΔ 50 Hz					
220 VΔ 50 Hz	660 VY 50 Hz	G ¹⁾	H ¹⁾	T	U	
230 VΔ 50 Hz	690 VY 50 Hz	415 VY 50 Hz	415 VΔ 50 Hz	660 VΔ 50 Hz	690 VΔ 50 Hz	
440 VY 60 Hz	440 VΔ 60 Hz					

¹⁾ On request for motor sizes 315.

Technical data – Dust ignition proof motors

Category 3 D - T125°C - IP 55
Aluminium frame, sizes 90 to 250



IC 411; Insulation class F, temperature rise class B

Output kW	Type designation	Product code	Speed r/min	Effi- ciency %	Power factor cos φ	Current		Torque			Moment of inertia J=1/4GD ² kgm ²	Sound pressure level LP dB(A)		
						I _N A	I _s I _N	T Nm	T _s T _N	T _{max} T _N			Weight kg	
3000 r/min = 2 poles														
400 V 50 Hz														
Basic design														
1.5	M3AAD 90 S	3GAA 091 001-••A	2870	80.1	0.82	3.35	5.5	5	2.4	3.0	0.0019	13	63	
2.2	M3AAD 90 L	3GAA 091 002-••A	2880	83.6	0.87	4.37	7.0	7.5	2.7	3.0	0.0024	16	63	
3	M3AAD 100 L	3GAA 101 001-••A	2900	86.0	0.88	5.95	7.5	10	2.7	3.6	0.0041	21	65	
4	M3AAD 112 M	3GAA 111 001-••B	2850	86.0	0.91	7.4	7.5	13.4	2.8	3.0	0.01	25	63	
5.5	M3AAD 132 SA	3GAA 131 001-••B	2855	86.0	0.88	10.5	7.8	18.4	3.2	3.4	0.014	37	75	
7.5	M3AAD 132 SB	3GAA 131 002-••B	2860	88.0	0.89	13.9	8.5	25.1	3.4	3.6	0.016	42	73	
11	M3AAD 160 MA	3GAA 161 101-••D	2930	91.2	0.88	20	6.3	36	1.9	2.5	0.039	73	69	
15	M3AAD 160 M	3GAA 161 102-••D	2920	91.7	0.90	26.5	6.6	49	2.3	2.5	0.047	84	69	
18.5	M3AAD 160 L	3GAA 161 103-••D	2920	92.4	0.91	32	7.3	60	2.6	2.7	0.053	94	69	
22	M3AAD 180 M	3GAA 181 101-••D	2930	92.8	0.89	38.5	7.2	71	2.5	2.7	0.077	119	69	
30	MBT 200 LA	AC 616 005-••	2945	91.1	0.89	53	6.5	97	2.6	3.0	0.142	172	75	
37	MBT 200 L	AC 616 006-••	2950	92.6	0.90	64	7.8	120	2.9	3.2	0.17	195	75	
45	MBT 225 M	AC 616 007-••	2950	92.1	0.89	79	7.1	146	2.2	3.1	0.284	225	75	
55	MBT 250 M	AC 616 008-••	2950	93.1	0.90	95	7.6	178	2.3	3.7	0.345	320	75	
3000 r/min = 2 poles														
400 V 50 Hz														
High-output design														
4	²⁾ M3AAD 100 LB	3GAA 101 002-••A	2900	85.0	0.86	8.1	7.5	13	2.7	3.6	0.005	25	68	
5.5	²⁾ M3AAD 112 MB	3GAA 111 002-••B	2855	86.5	0.93	9.9	7.3	18.4	2.7	2.9	0.012	33	66	
9.2	²⁾ M3AAD 132 SBB	3GAA 131 004-••B	2825	86.0	0.93	16.6	7.3	31.1	3.2	3.5	0.022	57	74	
11	²⁾ M3AAD 132 SC	3GAA 131 003-••B	2835	87.0	0.93	19.6	8.0	37	3.2	3.3	0.022	57	73	
30	²⁾ M3AAD 180 LB	3GAA 181 102-••D	2945	93.7	0.89	53	8.3	97	3.1	3.4	0.092	137	70	
1500 r/min = 4 poles														
400 V 50 Hz														
Basic design														
1.1	M3AAD 90 S	3GAA 092 001-••A	1410	77.5	0.81	2.59	5.0	7.5	2.2	2.7	0.0032	13	50	
1.5	M3AAD 90 L	3GAA 092 002-••A	1420	80.3	0.79	3.45	5.0	10	2.4	2.9	0.0043	16	50	
2.2	M3AAD 100 LA	3GAA 102 001-••A	1430	83.0	0.81	4.8	5.5	15	2.4	2.9	0.0069	21	64	
3	M3AAD 100 LB	3GAA 102 002-••A	1430	85.0	0.81	6.48	5.5	20	2.5	2.9	0.0082	24	66	
4	M3AAD 112 M	3GAA 112 001-••B	1435	84.5	0.80	8.6	7.0	26.6	2.9	3.1	0.015	27	60	
5.5	M3AAD 132 S	3GAA 132 001-••B	1450	87.0	0.83	11.1	7.3	36.2	2.2	3.0	0.031	40	66	
7.5	M3AAD 132 M	3GAA 132 002-••B	1450	88.0	0.83	14.8	7.9	49.4	2.5	3.2	0.038	48	66	
11	M3AAD 160 M	3GAA 162 101-••D	1460	90.3	0.81	21.5	6.7	72	2.9	2.8	0.067	75	62	
15	M3AAD 160 L	3GAA 162 102-••D	1465	91.8	0.80	30	6.8	97	2.9	3.3	0.091	94	62	
18.5	M3AAD 180 M	3GAA 182 101-••D	1470	92.3	0.84	35	7.0	120	3.1	2.7	0.161	124	62	
22	M3AAD 180 L	3GAA 182 102-••D	1470	92.6	0.83	41	7.0	143	2.9	2.8	0.191	141	63	
30	MBT 200 L	AC 616 013-••	1480	91.7	0.82	57	7.6	194	2.6	2.9	0.31	192	68	
37	MBT 225 S	AC 616 014-••	1485	93.2	0.82	70	6.8	238	2.7	2.7	0.405	225	70	
45	MBT 225 M	AC 616 015-••	1485	93.7	0.83	83	7.3	289	2.8	2.9	0.495	250	70	
55	MBT 250 M	AC 616 016-••	1485	93.7	0.82	103	7.0	354	2.7	3.0	0.567	320	70	
1500 r/min = 4 poles														
400 V 50 Hz														
High-output design														
1.85	²⁾ M3AAD 90 L	3GAA 092 003-••A	1390	79.5	0.80	4.4	4.5	13	2.2	2.4	0.0043	16	50	
2.2	²⁾ M3AAD 90 LB	3GAA 092 004-••A	1390	80.3	0.83	4.85	4.5	15	2.2	2.4	0.0048	17	50	
4	²⁾ M3AAD 100 LC	3GAA 102 003-••A	1420	81.0	0.82	8.65	5.5	27	2.5	2.8	0.009	25	60	
5.5	²⁾ M3AAD 112 MB	3GAA 112 002-••B	1425	84.5	0.83	11.4	7.1	36.9	2.8	3.1	0.018	34	60	
9.2	²⁾ M3AAD 132 MBA	3GAA 132 004-••B	1450	88.0	0.85	17.8	7.3	60	2.0	2.8	0.048	59	63	
11	²⁾ M3AAD 132 MB	3GAA 132 003-••B	1450	88.0	0.86	21	8.3	72	2.5	2.7	0.048	59	66	

¹⁾ Motors are certified for the voltages 380-400 V 50 Hz according to IEC 60034-1. Values above are given for 400 V 50 Hz; data for any voltages < 500 V on request.

²⁾ Temperature rise class F.

Notes:

When ordering motors, variant code 452 'DIP according to EN 50281-1-1, T= 125°C, category 3 D, IP 55' has to be added.

During the transition period some motor types belonging to M3000 range still have the old product codes and type designations. Always check the valid code before ordering.

Data for other voltages and frequencies, on request.

The two bullets in the product code indicate choice of mounting arrangement (see ordering information), voltage and frequency (below).

S	D	E	F	G	H	X
380-400 VY 50 Hz	380-400 VΔ 50 Hz	500 VΔ 50 Hz	500 VY 50 Hz	415 VY 50 Hz	415 VΔ 50 Hz	Other rated voltage, connection or frequency, max. 500 V
220-230 VΔ 50 Hz	440-460 VΔ 60 Hz					
440-460 VY 60 Hz						

Technical data – Dust ignition proof motors

Category 3 D - T125°C - IP 55
Aluminium frame, sizes 90 to 250



IC 411; Insulation class F, temperature rise class B

Output kW	Type designation	Product code	Speed r/min	Effi- ciency %	Power factor cos φ	Current		Torque			Moment of inertia J=1/4GD ² kgm ²	Weight kg	Sound pressure level LP dB(A)			
						I _N A	I _s I _N	T Nm	T _s T _N	T _{max} T _N						
1000 r/min = 6 poles													400 V 50 Hz		Basic design	
0.75	M3AAD 90 S	3GAA 093 001-••A	930	71.5	0.67	2.36	4.0	7.5	1.9	2.3	0.0032	13	44			
1.1	M3AAD 90 L	3GAA 093 002-••A	930	74.4	0.69	3.25	4.0	11	1.9	2.3	0.0043	16	44			
1.5	M3AAD 100 L	3GAA 103 001-••A	950	80.0	0.71	3.92	4.5	15	1.9	2.3	0.0082	23	49			
2.2	M3AAD 112 M	3GAA 113 001-••B	940	80.5	0.74	5.4	5.6	22.3	2.1	2.7	0.015	27	66			
3	M3AAD 132 S	3GAA 133 001-••B	960	84.5	0.75	6.9	6.1	29.8	2.0	2.6	0.031	39	57			
4	M3AAD 132 MA	3GAA 133 002-••B	960	85.5	0.78	8.7	7.1	39.7	2.0	2.8	0.038	46	61			
5.5	M3AAD 132 MB	3GAA 133 003-••B	955	86.0	0.78	11.9	6.9	55	2.2	2.8	0.045	54	57			
7.5	M3AAD 160 M	3GAA 163 101-••D	970	89.3	0.79	15.4	6.7	74	2.0	2.8	0.089	88	59			
11	M3AAD 160 L	3GAA 163 102-••D	970	89.8	0.78	23	7.1	109	2.2	2.9	0.107	102	59			
15	M3AAD 180 L	3GAA 183 101-••D	970	90.8	0.78	31	7.0	148	2.1	3.0	0.217	151	59			
18.5	MBT 200 LA	AC 616 020-••	980	89.5	0.80	37	6.4	180	2.1	3.0	0.315	192	68			
22	MBT 200 L	AC 616 021-••	980	89.5	0.80	45	7.4	214	2.3	3.1	0.34	202	68			
30	MBT 225 M	AC 616 022-••	985	91.5	0.83	57	6.5	291	1.7	3.1	0.766	235	68			
37	MBT 250 M	AC 616 023-••	985	92.0	0.82	71	6.5	359	1.9	3.3	0.88	330	69			
1000 r/min = 6 poles													400 V 50 Hz		High-output design	
2.2	²⁾ M3AAD 100 LC	3GAA 103 002-••A	940	77.0	0.71	5.9	4.5	22	1.9	2.3	0.009	26	49			
6.5	²⁾ M3AAD 132 MC	3GAA 133 004-••B	960	85.0	0.75	14.8	6.6	64	2.0	2.7	0.049	59	61			
14	²⁾ M3AAD 160 LB	3GAA 163 103-••D	960	89.1	0.77	29.5	7.6	139	2.7	3.1	0.127	117	62			
18.5	²⁾ M3AAD 180 LB	3GAA 183 102-••D	965	90.6	0.79	37.5	6.2	183	2.0	2.6	0.237	160	59			
750 r/min = 8 poles													400 V 50 Hz		Basic design	
0.37	M3AAD 90 S	3GAA 094 001-••A	700	61.5	0.56	1.6	3.0	5	1.9	2.4	0.0032	13	43			
0.55	M3AAD 90 L	3GAA 094 002-••A	690	62.9	0.57	2.35	3.0	7.5	1.7	2.1	0.0043	16	43			
0.75	M3AAD 100 LA	3GAA 104 001-••A	700	72.0	0.59	2.55	3.5	10	2.1	2.7	0.0069	20	46			
1.1	M3AAD 100 LB	3GAA 104 002-••A	700	73.0	0.64	3.35	3.5	15	2.1	2.7	0.0082	23	46			
1.5	M3AAD 112 M	3GAA 114 001-••B	695	74.5	0.65	4.5	4.1	20.6	1.9	2.4	0.016	28	52			
2.2	M3AAD 132 S	3GAA 134 001-••B	720	80.5	0.67	5.9	5.3	29.2	1.6	2.5	0.038	46	56			
3	M3AAD 132 M	3GAA 134 002-••B	720	82.0	0.68	7.8	5.5	39.8	1.8	2.5	0.045	53	56			
4	M3AAD 160 MA	3GAA 164 101-••D	715	84.1	0.69	10	5.2	54	2.1	2.4	0.072	75	59			
5.5	M3AAD 160 M	3GAA 164 102-••D	710	84.7	0.70	13.4	5.4	74	2.4	2.6	0.091	88	59			
7.5	M3AAD 160 L	3GAA 164 103-••D	715	86.3	0.70	18.1	5.4	100	2.4	2.8	0.131	118	59			
11	M3AAD 180 L	3GAA 184 101-••D	720	88.7	0.76	23.5	5.9	146	2.4	2.6	0.224	147	59			
15	MBT 200 L	AC 616 028-••	730	85.6	0.75	34	5.7	196	2.0	3.0	0.314	187	64			
18.5	MBT 225 S	AC 616 029-••	730	88.1	0.78	39	5.3	242	2.1	2.4	0.587	215	65			
22	MBT 225 M	AC 616 030-••	735	89.1	0.77	46	5.6	286	2.2	2.7	0.722	235	65			
30	MBT 250 M	AC 616 031-••	735	89.6	0.74	65	5.9	390	2.5	3.0	0.83	330	65			
750 r/min = 8 poles													400 V 50 Hz		High-output design	
3.8	²⁾ M3AAD 132 MB	3GAA 134 003-••B	710	80.5	0.69	9.9	5.2	51	1.8	2.3	0.049	59	56			

¹⁾ Motors are certified for the voltages 380-400 V 50 Hz according to IEC 60034-1. Values above are given for 400 V 50 Hz; data for any voltages < 500 V on request.

²⁾ Temperature rise class F.

Notes:
When ordering motors, variant code 452 'DIP according to EN 50281-1-1, T= 125°C, category 3 D, IP 55' has to be added.

During the transition period some motor types belonging to M3000 range still have the old product codes and type designations. Always check the valid code before ordering.

Data for other voltages and frequencies, on request.

The two bullets in the product code indicate choice of mounting arrangement (see ordering information), voltage and frequency (below).

S	D	E	F	G	H	X
380-400 VY 50 Hz	380-400 VΔ 50 Hz	500 VΔ 50 Hz	500 VY 50 Hz	415 VY 50 Hz	415 VΔ 50 Hz	Other rated voltage, connection or frequency, max. 500 V
220-230 VΔ 50 Hz	440-460 VΔ 60 Hz					
440-460 VY 60 Hz						

Technical data – Dust ignition proof motors

Category 3 D - T125°C - IP 55
Cast iron frame, sizes 71 to 355



IC 411; Insulation class F, temperature rise class B

Output kW	Type designation	Product code	Speed r/min	Effi- ciency %	Power factor cos φ	Current		Torque			Moment of inertia J=1/4GD ² kgm ²	Weight kg	Sound pressure level LP dB(A)
						I _N A	I _s I _N	T Nm	T _s T _N	T _{max} T _N			
3000 r/min = 2 poles			400 V 50 Hz ¹⁾						Basic design				
0.37	M2BA 71 M2 A	3GBA 071 310-••A	2810	71.0	0.80	0.94	6.1	1.3	2.2	2.2	0.0003	10	56
0.55	M2BA 71 M2 B	3GBA 071 320-••A	2800	74.0	0.82	1.31	6.1	1.9	2.2	2.2	0.0004	11	56
0.75	M2BA 80 M2 A	3GBA 081 301-••A	2850	77.2	0.86	1.63	6.1	2.5	2.2	2.2	0.0009	16	57
1.1	M2BA 80 M2 B	3GBA 081 302-••A	2850	80.2	0.85	2.33	7.0	3.7	2.2	2.2	0.0009	17	58
1.5	M2BA 90 S2 A	3GBA 091 101-••A	2850	81.6	0.85	3.13	7.0	5	2.2	2.2	0.0014	21	61
2.2	M2BA 90 L2 A	3GBA 091 501-••A	2850	84.2	0.84	4.49	7.0	7.4	2.2	2.2	0.0016	24	61
3	M2BA 100 L2 A	3GBA 101 501-••A	2870	85.1	0.86	5.92	7.0	10	2.2	2.2	0.004	33	65
4	M2BA 112 M2 A	3GBA 111 301-••A	2900	86.0	0.89	7.52	7.0	13.2	2.2	2.2	0.0067	42	67
5.5	M2BA 132 S2 A	3GBA 131 101-••A	2920	88.6	0.88	10.2	7.0	18	2.2	2.2	0.0124	58	70
7.5	M2BA 132 S2 B	3GBA 131 102-••A	2920	89.9	0.89	13.5	7.0	24.5	2.2	2.2	0.0149	63	70
11	M3GP 160 MLA	3GGP 161 410-••G	2936	91.2	0.87	20	7.2	36	2.9	3.3	0.039	147	71
15	M3GP 160 MLB	3GGP 161 420-••G	2934	91.6	0.88	28	7.5	49	3.1	3.5	0.047	156	71
18.5	M3GP 160 MLC	3GGP 161 430-••G	2934	92.4	0.90	33	7.5	60	2.8	3.4	0.054	167	71
22	M3GP 180 MLA	3GGP 181 410-••G	2938	92.6	0.90	39	6.9	72	2.5	3.1	0.077	194	71
30	M3GP 200 MLA	3GGP 201 410-••G	2946	94.0	0.88	54	7.4	97	3.0	3.2	0.15	275	74
37	M3GP 200 MLC	3GGP 201 430-••G	2948	94.1	0.89	65	7.6	120	2.9	3.2	0.19	305	77
45	M3GP 225 SMB	3GGP 221 220-••G	2968	94.7	0.87	79	7.2	145	2.7	3.0	0.26	365	76
55	M3GP 250 SMA	3GGP 251 210-••G	2970	94.6	0.88	96	7.7	177	2.4	3.1	0.49	425	75
75	M3GP 280 SMA	3GGP 281 210-••G	2978	94.8	0.88	131	7.6	240	2.1	3.0	0.8	625	77
90	M3GP 280 SMB	3GGP 281 220-••G	2976	95.1	0.90	152	7.4	289	2.1	2.9	0.9	665	77
110	M3GP 315 SMA	3GGP 311 210-••G	2982	95.1	0.86	194	7.6	352	2.0	3.0	1.2	880	78
132	M3GP 315 SMB	3GGP 311 220-••G	2982	95.4	0.88	228	7.4	423	2.2	3.0	1.4	940	78
160	M3GP 315 SMC	3GGP 311 230-••G	2981	96.1	0.89	269	7.5	513	2.3	3.0	1.7	1025	78
200	M3GP 315 MLA	3GGP 311 410-••G	2980	96.3	0.90	336	7.7	641	2.6	3.0	2.1	1190	78
250	M2BA 355 S	3GBA 351 100-••A	2980	96.1	0.92	410	6.6	801	1.3	3.0	3.8	1550	83
315	M2BA 355 SMA	3GBA 351 210-••A	2978	96.6	0.92	510	7.7	1010	1.3	3.3	4.8	1750	83
345	M2BA 355 SMB	3GBA 351 220-••A	2975	96.4	0.92	563	7.3	1110	1.2	3.3	4.8	1750	83
400	M2BA 355 MLA	3GBA 351 410-••A	2982	96.6	0.92	655	7.7	1281	1.6	3.3	6	2150	83
430	M2BA 355 MLC	3GBA 351 430-••A	2978	96.6	0.92	700	8.2	1444	1.3	3.3	6	2150	83
3000 r/min = 2 poles			400 V 50 Hz ¹⁾						High-output design				
22	M3GP 160 MLD	3GGP 161 440-••G	2929	91.4	0.90	39	7.4	72	2.8	3.4	0.059	173	77
30	M3GP 180 MLB	3GGP 181 420-••G	2944	92.8	0.88	54	7.5	97	2.8	3.5	0.092	210	78
55	M3GP 225 SMC	3GGP 221 230-••G	2965	94.3	0.88	96	7.1	177	2.6	3.0	0.29	385	80
75	M3GP 250 SMB	3GGP 251 220-••G	2969	95.1	0.89	129	7.9	241	2.6	3.2	0.57	465	80
110	M3GP 280 SMC	3GGP 281 230-••G	2978	95.7	0.90	185	7.9	353	2.4	3.0	1.15	725	77

¹⁾ Motors are certified for the voltages 380-400-415 V 50 Hz according to IEC 60034-1. Values above are given for 400 V 50 Hz; data for other voltages on request.

²⁾ Temperature rise class F.

ATEX certification process ongoing for frame size 355.

Notes:

- When ordering motors, variant code 452 'DIP according to EN 50281-1-1, T= 125°C, category 3 D, IP 55' has to be added.
- When ordering sizes 160-200 with lifetime lubrication, variant code 194 'ZZ-bearings at both ends' has to be added.

Data for other voltages and frequencies, on request.

The two bullets in the product code indicate choice of mounting arrangement (see ordering information), voltage and frequency (below).

S	D	A ¹⁾	B ¹⁾	E	F ²⁾	X
380 VY 50 Hz	380 VΔ 50 Hz	380 VY 50 Hz	380 VΔ 50 Hz	500 VΔ 50 Hz	500 VY 50 Hz	Other rated voltage, connection or frequency, max. 690 V
400 VY 50 Hz	400 VΔ 50 Hz	220 VΔ 50 Hz	660 VY 50 Hz	575 VΔ 60 Hz		
415 VY 50 Hz	415 VΔ 50 Hz					
220 VΔ 50 Hz	660 VY 50 Hz	G ¹⁾	H ¹⁾	T ²⁾	U ²⁾	
230 VΔ 50 Hz	690 VY 50 Hz	415 VY 50 Hz	415 VΔ 50 Hz	660 VΔ 50 Hz	690 VΔ 50 Hz	
440 VY 60 Hz	440 VΔ 60 Hz					

¹⁾ On request for motor sizes 315-355.

²⁾ On request for motor sizes 355.

Technical data – Dust ignition proof motors

Category 3 D - T125°C - IP 55
Cast iron frame, sizes 71 to 355



IC 411; Insulation class F, temperature rise class B

Output kW	Type designation	Product code	Speed r/min	Efficiency %	Power factor cos φ	Current		Torque			Moment of inertia J=1/4GD ² kgm ²	Weight kg	Sound pressure level LP dB(A)
						I _N A	I _s / I _N	T Nm	T _s / T _N	T _{max} / T _N			
1500 r/min = 4 poles													
400 V 50 Hz ¹⁾													
Basic design													
0.25	M2BA 71 M4 A	3GBA 072 310-••A	1390	66.3	0.73	0.75	5.2	1.7	2.1	2.0	0.0005	11	43
0.37	M2BA 71 M4 B	3GBA 072 320-••A	1380	70.8	0.75	1.01	5.2	2.6	2.1	2.0	0.0007	11	45
0.55	M2BA 80 M4 A	3GBA 082 301-••A	1410	75.0	0.73	1.45	5.2	3.7	2.4	2.0	0.0014	16	46
0.75	M2BA 80 M4 B	3GBA 082 302-••A	1400	76.3	0.76	1.87	6.0	5.1	2.4	2.2	0.0017	17	46
1.1	M2BA 90 S4 A	3GBA 092 101-••A	1400	78.5	0.78	2.6	6.0	7.5	2.3	2.2	0.0025	21	52
1.5	M2BA 90 L4 A	3GBA 092 501-••A	1390	80.5	0.78	3.45	6.0	10.3	2.3	2.2	0.0032	25	52
2.2	M2BA 100 L4 A	3GBA 102 501-••A	1430	82.5	0.80	4.82	6.0	14.7	2.3	2.2	0.0068	32	53
3	M2BA 100 L4 B	3GBA 102 502-••A	1420	84.5	0.82	6.25	6.5	20.2	2.3	2.2	0.0086	36	53
4	M2BA 112 M4 A	3GBA 112 301-••A	1430	86.0	0.81	8.24	6.5	26.7	2.3	2.2	0.0131	45	56
5.5	M2BA 132 S4 A	3GBA 132 101-••A	1430	87.4	0.84	10.8	6.5	36.7	2.3	2.2	0.0267	60	59
7.5	M2BA 132 M4 A	3GBA 132 301-••A	1440	89.0	0.85	14.3	6.5	49.7	2.3	2.2	0.0343	73	59
11	M3GP 160 MLC	3GGP 162 430-••G	1470	91.3	0.82	22.5	7.7	71	3.1	3.6	0.09	166	62
15	M3GP 160 MLE	3GGP 162 450-••G	1467	92.0	0.83	30	7.6	98	3.1	3.6	0.121	189	67
18.5	M3GP 180 MLA	3GGP 182 410-••G	1474	92.5	0.82	36	7.3	120	2.7	3.2	0.176	206	62
22	M3GP 180 MLB	3GGP 182 420-••G	1471	92.6	0.82	42	7.1	143	2.6	3.0	0.191	214	62
30	M3GP 200 MLB	3GGP 202 420-••G	1475	93.5	0.84	56	7.4	194	3.3	3.0	0.34	305	61
37	M3GP 225 SMB	3GGP 222 220-••G	1480	93.6	0.84	69	7.7	239	3.1	3.1	0.42	355	67
45	M3GP 225 SMC	3GGP 222 230-••G	1477	94.4	0.86	81	7.4	291	3.1	3.0	0.49	390	67
55	M3GP 250 SMA	3GGP 252 210-••G	1479	94.6	0.83	101	6.9	355	2.5	3.1	0.72	415	66
75	M3GP 280 SMA	3GGP 282 210-••G	1484	94.9	0.85	135	6.9	483	2.5	2.8	1.25	625	68
90	M3GP 280 SMB	3GGP 282 220-••G	1483	95.2	0.86	159	7.2	580	2.5	2.7	1.5	665	68
110	M3GP 315 SMA	3GGP 312 210-••G	1487	95.6	0.86	193	7.2	706	2.0	2.5	2.3	900	70
132	M3GP 315 SMB	3GGP 312 220-••G	1487	95.8	0.86	232	7.1	848	2.3	2.7	2.6	960	70
160	M3GP 315 SMC	3GGP 312 230-••G	1487	96.0	0.85	287	7.2	1028	2.4	2.9	2.9	1000	70
200	M3GP 315 MLA	3GGP 312 410-••G	1486	96.2	0.86	351	7.2	1285	2.5	2.9	3.5	1160	70
250	M2BA 355 S	3GBA 352 100-••A	1487	96.5	0.87	430	7.2	1606	2.3	2.7	6.5	1550	80
315	M2BA 355 SMA	3GBA 352 210-••A	1488	96.7	0.87	545	7.6	2022	2.5	2.9	8.2	1800	80
345	M2BA 355 SMB	3GBA 352 220-••A	1486	96.7	0.87	590	7.0	2217	2.3	2.7	8.2	1800	80
400	M2BA 355 MLA	3GBA 352 410-••A	1489	96.8	0.87	685	6.9	2565	1.6	2.8	10	2100	80
450	M2BA 355 MLB	3GBA 352 420-••A	1489	96.8	0.87	770	7.6	2886	1.5	3.0	10	2100	80
500	M2BA 355 MLC	3GBA 352 430-••A	1489	96.8	0.88	845	7.6	3207	1.3	2.9	10.5	2100	83

1500 r/min = 4 poles													
400 V 50 Hz ¹⁾													
High-output design													
18.5	M3GP 160 MLF	3GGP 162 460-••G	1466	92.0	0.82	36.5	8.0	120	3.2	3.6	0.121	189	68
30 ²⁾	M3GP 180 MLC	3GGP 182 430-••G	1473	92.3	0.80	59	7.8	194	3.1	3.4	0.239	233	66
37	M3GP 200 MLC	3GGP 202 430-••G	1475	93.3	0.82	70	7.5	239	3.5	3.2	0.34	305	73
55	M3GP 225 SMD	3GGP 222 240-••G	1476	94.0	0.85	100	7.6	356	3.3	3.1	0.49	390	74
75	M3GP 250 SMB	3GGP 252 220-••G	1476	94.7	0.86	133	7.2	485	2.7	3.2	0.88	470	73
110	M3GP 280 SMC	3GGP 282 230-••G	1485	95.6	0.86	195	7.6	707	3.0	3.0	1.85	725	68

¹⁾ Motors are certified for the voltages 380-400-415 V 50 Hz according to IEC 60034-1.

Values above are given for 400 V 50 Hz; data for other voltages on request.

²⁾ Temperature rise class F.

ATEX certification process ongoing for frame size 355.

Notes:

- When ordering motors, variant code 452 'DIP according to EN 50281-1-1, T= 125°C, category 3 D, IP 55' has to be added
- When ordering sizes 160-200 with lifetime lubrication, variant code 194 'ZZ-bearings at both ends' has to be added.

Data for other voltages and frequencies, on request.

The two bullets in the product code indicate choice of mounting arrangement (see ordering information), voltage and frequency (below).

S	D	A ¹⁾	B ¹⁾	E	F ²⁾	X
380 VY 50 Hz	380 VΔ 50 Hz	380 VY 50 Hz	380 VΔ 50 Hz	500 VΔ 50 Hz	500 VY 50 Hz	Other rated voltage, connection or frequency, max. 690 V
400 VY 50 Hz	400 VΔ 50 Hz	220 VΔ 50 Hz	660 VY 50 Hz	575 VΔ 60 Hz		
415 VY 50 Hz	415 VΔ 50 Hz					
220 VΔ 50 Hz	660 VY 50 Hz	G ¹⁾	H ¹⁾	T ²⁾	U ²⁾	
230 VΔ 50 Hz	690 VY 50 Hz	415 VY 50 Hz	415 VΔ 50 Hz	660 VΔ 50 Hz	690 VΔ 50 Hz	
440 VY 60 Hz	440 VΔ 60 Hz					

¹⁾ On request for motor sizes 315-355.

²⁾ On request for motor sizes 355.

Technical data – Dust ignition proof motors

Category 3 D - T125°C - IP 55
Cast iron frame, sizes 71 to 355



IC 411; Insulation class F, temperature rise class B

Output kW	Type designation	Product code	Speed r/min	Efficiency %	Power factor cos φ	Current		Torque			Moment of inertia J=1/4GD ² kgm ²	Weight kg	Sound pressure level LP dB(A)
						I _N A	I _s /I _N	T Nm	T _s /T _N	T _{max} /T _N			
1000 r/min = 6 poles			400 V 50 Hz ¹⁾					Basic design					
0.18	M2BA 71 M6 A	3GBA 073 310-••A	880	57.0	0.63	0.73	4.0	1.95	1.7	1.8	0.0006	10	42
0.25	M2BA 71 M6 B	3GBA 073 320-••A	880	61.5	0.65	0.91	4.0	2.71	1.7	1.8	0.0007	11	42
0.37	M2BA 80 M6 A	3GBA 083 301-••A	920	68.0	0.65	1.21	5.0	3.84	1.7	1.8	0.0016	17	45
0.55	M2BA 80 M6 B	3GBA 083 302-••A	920	70.0	0.66	1.72	5.0	5.71	1.7	1.8	0.002	18	45
0.75	M2BA 90 S6 A	3GBA 093 101-••A	920	74.0	0.71	2.08	5.0	7.79	2.0	2.2	0.0029	21	48
1.1	M2BA 90 L6 A	3GBA 093 501-••A	920	75.0	0.73	2.9	5.0	11.42	2.0	2.2	0.0038	25	48
1.5	M2BA 100 L6 A	3GBA 103 501-••A	930	79.0	0.73	3.76	5.5	15.4	2.0	2.2	0.001	32	51
2.2	M2BA 112 M6 A	3GBA 113 301-••A	940	83.0	0.73	5.24	5.5	22.35	2.0	2.2	0.0156	40	54
3	M2BA 132 S6 A	3GBA 133 101-••A	960	84.5	0.77	6.67	6.5	29.84	2.0	2.2	0.0312	55	56
4	M2BA 132 M6 A	3GBA 133 301-••A	960	85.0	0.76	8.94	6.5	39.79	2.0	2.2	0.0407	65	56
5.5	M2BA 132 M6 B	3GBA 133 302-••A	950	87.0	0.78	11.7	6.5	55	2.0	2.2	0.0533	75	56
7.5	M3GP 160 MLA	3GGP 163 410-••G	965	88.6	0.80	15.5	6.5	74	1.9	3.0	0.088	160	57
11	M3GP 160 MLB	3GGP 163 420-••G	965	89.2	0.79	23	7.1	109	2.1	3.3	0.106	173	65
15	M3GP 180 MLB	3GGP 183 420-••G	972	91.1	0.80	31	7.0	147	1.9	3.3	0.221	233	67
18.5	M3GP 200 MLA	3GGP 203 410-••G	983	91.3	0.80	37	7.1	180	3.2	3.1	0.37	265	66
22	M3GP 200 MLB	3GGP 203 420-••G	983	91.6	0.81	43	7.5	214	3.2	3.2	0.43	285	61
30	M3GP 225 SMB	3GGP 223 220-••G	985	92.8	0.81	58	7.4	291	3.4	3.0	0.64	350	61
37	M3GP 250 SMA	3GGP 253 210-••G	987	93.4	0.81	71	7.2	358	3.2	2.9	1.16	420	66
45	M3GP 280 SMA	3GGP 283 210-••G	990	94.4	0.84	82	7.0	434	2.5	2.5	1.85	605	66
55	M3GP 280 SMB	3GGP 283 220-••G	990	94.6	0.84	101	7.0	531	2.7	2.6	2.2	645	66
75	M3GP 315 SMA	3GGP 313 210-••G	992	95.0	0.82	141	7.4	722	2.4	2.8	3.2	830	70
90	M3GP 315 SMB	3GGP 313 220-••G	992	95.5	0.84	163	7.5	866	2.4	2.8	4.1	930	70
110	M3GP 315 SMC	3GGP 313 230-••G	991	95.6	0.83	202	7.4	1060	2.5	2.9	4.9	1000	70
132	M3GP 315 MLA	3GGP 313 410-••G	991	95.8	0.83	240	7.5	1272	2.7	3.0	5.8	1150	68
160	M2BA 355 S	3GBA 353 100-••A	992	95.9	0.85	280	6.8	1540	1.8	2.7	10.4	1500	75
200	M2BA 355 SMA	3GBA 353 210-••A	992	95.9	0.85	355	7.1	1925	2.0	2.7	12.5	1800	75
250	M2BA 355 SMB	3GBA 353 220-••A	992	96.0	0.84	450	7.5	2407	2.2	2.8	12.5	1800	75
305	M2BA 355 MLA	3GBA 353 410-••A	991	96.2	0.84	550	7.5	2940	2.1	3.1	14.6	2100	75
355	M2BA 355 MLC	3GBA 353 430-••A	991	96.4	0.84	635	7.6	3421	1.5	3.0	15.8	2100	78
1000 r/min = 6 poles			400 V 50 Hz ¹⁾					High-output design					
14 ²⁾	M3GP 160 MLC	3GGP 163 430-••G	969	88.9	0.74	31	7.9	138	2.8	3.9	0.121	188	64
30	M3GP 200 MLC	3GGP 203 430-••G	983	91.6	0.80	60	7.5	292	3.5	3.4	0.49	305	65
37	M3GP 225 SMC	3GGP 223 230-••G	983	92.8	0.83	70	7.1	359	3.2	2.8	0.75	380	64
45	M3GP 250 SMB	3GGP 253 220-••G	986	93.7	0.82	85	7.2	436	3.3	2.8	1.49	465	65
75	M3GP 280 SMC	3GGP 283 230-••G	990	95.1	0.84	137	7.3	723	2.8	2.7	2.85	725	66

¹⁾ Motors are certified for the voltages 380-400-415 V 50 Hz according to IEC 60034-1.

Values above are given for 400 V 50 Hz; data for other voltages on request.

²⁾ Temperature rise class F.

ATEX certification process ongoing for frame size 355.

Notes:

- When ordering motors, variant code 452 'DIP according to EN 50281-1-1, T= 125°C, category 3 D, IP 55' has to be added
- When ordering sizes 160-200 with lifetime lubrication, variant code 194 '2Z-bearings at both ends' has to be added.

Data for other voltages and frequencies, on request.

Technical data – Dust ignition proof motors

Category 3 D - T125°C - IP 55
Cast iron frame, sizes 71 to 355



IC 411; Insulation class F, temperature rise class B

Output kW	Type designation	Product code	Speed r/min	Effi- ciency %	Power factor %	Power I_N cos ϕ	Current		Torque		Moment of inertia		Weight kg	Sound pressure level LP dB(A)
							I_s A	T_N	T_s Nm	T_{max} T_N	$J=1/4GD^2$ T_N	T_N		
750 r/min = 8 poles			400 V 50 Hz ¹⁾						Basic design					
4	M3GP 160 MLA	3GGP 164 410-••G	717	83.0	0.70	10.1	5.2	53	1.8	2.8	0.071	146	59	
5.5	M3GP 160 MLB	3GGP 164 420-••G	715	84.1	0.70	13.9	5.2	73	1.9	2.8	0.09	160	53	
7.5	M3GP 160 MLC	3GGP 164 430-••G	718	86.4	0.69	18.4	5.7	100	2.1	3.1	0.121	188	55	
11	M3GP 180 MLB	3GGP 184 420-••G	724	89.9	0.72	24.5	5.7	145	1.7	2.7	0.239	227	63	
15	M3GP 200 MLA	3GGP 204 410-••G	734	90.4	0.78	31	7.0	195	2.4	3.2	0.45	280	56	
18.5	M3GP 225 SMA	3GGP 224 210-••G	734	90.5	0.73	41	6.1	241	2.2	3.0	0.61	335	55	
22	M3GP 225 SMB	3GGP 224 220-••G	732	90.7	0.76	46	6.5	287	2.2	2.9	0.68	350	56	
30	M3GP 250 SMA	3GGP 254 210-••G	735	92.0	0.78	61	6.7	390	2.0	2.9	1.25	420	56	
37	M3GP 280 SMA	3GGP 284 210-••G	741	93.4	0.78	74	7.3	477	1.7	3.0	1.85	605	65	
45	M3GP 280 SMB	3GGP 284 220-••G	741	94.0	0.78	90	7.6	580	1.8	3.1	2.2	645	65	
55	M3GP 315 SMA	3GGP 314 210-••G	742	94.1	0.81	104	7.1	708	1.6	2.7	3.2	830	62	
75	M3GP 315 SMB	3GGP 314 220-••G	741	94.4	0.82	141	7.1	968	1.7	2.7	4.1	930	62	
90	M3GP 315 SMC	3GGP 314 230-••G	741	94.8	0.82	167	7.4	1161	1.8	2.7	4.9	1000	64	
110	M3GP 315 MLA	3GGP 314 410-••G	740	95.0	0.83	203	7.3	1420	1.8	2.7	5.8	1150	72	
132	M2BA 355 S	3GBA 354 100-••A	742	95.0	0.80	250	5.8	1699	1.5	2.3	10.4	1550	75	
160	M2BA 355 SMA	3GBA 354 210-••A	742	95.2	0.80	305	6.3	2059	1.7	2.4	12.5	1800	75	
200	M2BA 355 MLA	3GBA 354 410-••A	743	95.5	0.77	395	6.6	2571	1.8	2.7	14.6	2100	75	
250	M2BA 355 MLC	3GBA 354 430-••A	744	95.7	0.80	470	6.6	3209	1.5	3.0	15.8	2100	75	
750 r/min = 8 poles			400 V 50 Hz ¹⁾						High-output design					
18.5	M3GP 200 MLB	3GGP 204 420-••G	734	90.3	0.79	37.5	6.9	241	2.2	3.2	0.54	300	57	
30 ²⁾	M3GP 225 SMC	3GGP 224 230-••G	731	90.3	0.76	63	6.3	392	2.3	3.0	0.75	375	59	
37	M3GP 250 SMB	3GGP 254 220-••G	737	92.8	0.77	75	7.5	479	2.3	3.4	1.52	465	65	
55	M3GP 280 SMC	3GGP 284 230-••G	741	94.4	0.80	105	7.9	709	1.9	3.1	2.85	725	65	

¹⁾ Motors are certified for the voltages 380-400-415 V 50 Hz according to IEC 60034-1.
Values above are given for 400 V 50 Hz; data for other voltages on request.

ATEX certification process ongoing for frame size 355.

Notes:

- When ordering motors, variant code 452 'DIP according to EN 50281-1-1, T= 125°C, category 3 D, IP 55' has to be added
- When ordering sizes 160-200 with lifetime lubrication, variant code 194 '2Z-bearings at both ends' has to be added.

Data for other voltages and frequencies, on request.

The two bullets in the product code indicate choice of mounting arrangement (see ordering information), voltage and frequency (below).

S	D	A ¹⁾	B ¹⁾	E	F ²⁾	X
380 VY 50 Hz	380 VΔ 50 Hz	380 VY 50 Hz	380 VΔ 50 Hz	500 VΔ 50 Hz	500 VY 50 Hz	Other rated voltage, connection or frequency, max. 690 V
400 VY 50 Hz	400 VΔ 50 Hz	220 VΔ 50 Hz	660 VY 50 Hz	575 VΔ 60 Hz		
415 VY 50 Hz	415 VΔ 50 Hz					
220 VΔ 50 Hz	660 VY 50 Hz	G ¹⁾	H ¹⁾	T ²⁾	U ²⁾	
230 VΔ 50 Hz	690 VY 50 Hz	415 VY 50 Hz	415 VΔ 50 Hz	660 VΔ 50 Hz	690 VΔ 50 Hz	
440 VY 60 Hz	440 VΔ 60 Hz					

¹⁾ On request for motor sizes 315-355.

²⁾ On request for motor sizes 355.

Rating plates

For motor sizes 80 to 132 the rating plate gives one current value for the voltage area. That is the highest current that can occur within the voltage area with the given output. Aluminium motors in category 3D, frame sizes 90 to 100, are self-certified.

For cast iron motor sizes 160 to 400 the rating plate is in table form giving values for speed, current and power factor for six voltages.

European standards require a special marking on dust ignition proof motors. The marking shall include the following:

- type of protection
- apparatus category
- temperature class
- name and EC reference number of the notified body
- certificate number

Aluminium motors, sizes 90-100

ABB Automation Products, S.A.					
3~ Motor M3AAD 090 L-2 F IP 65 IEC 34-1					
3GAA091002-ADB					
N°					
V	Hz	r/min	kW	A	Cos φ
380 - 400 D	50	2870	2,20	4,70	0,86
T 125 °C					
LOM 99 ATEX 2025					
		2002		16,00 kg	
6305 2RS1/C3		6204 2RS1/C3			

Aluminium motors, sizes 112-132

ABB Automation Products, S.A.					
3~ Motor M3AAD 112 M-2 F IP 65 IEC 34-1					
3GAA111001-ADB					
N°					
V	Hz	r/min	kW	A	Cos φ
380 - 400 D	50	2850	4,00	7,80	0,91
T 125 °C					
LOM 99 ATEX 2025					
		2002		25,00 kg	
6206 2RS1/C3		6205 2RS1/C3			

Aluminium motors, sizes 160-180

ABB Automation Products, S.A.					
Polígono Industrial S.O. Sant Quirze del Valles 08192-Barcelona-Spain					
3~ Motor M3AAD 160 MA-2					
No.					
2002		Ins. cl. F		IP 65	
V	Hz	kW	r/min	A	cos φ
400 Y	50	11,00	2930	20,00	0,88
380 Y	50	11,00	2915	20,50	0,89
Prod. code 3GAA161101-ASD					
LOM 99 ATEX 2025					
6309 2RS1/C3		6209 2RS1/C3		73,00 kg	
				T 125 °C IEC 34-1	

Aluminium motors, sizes 200-250

ABB Automation Products, S.A.					
N° AC616005-AD Motor 3~					
50 Hz		Type MBT 200 LA-2		T 125 °C	
2002		30 kW			
380 D		V 55 A			
V A					
		2940 r/m		Cl. F	
		Cos φ 0,88		IP 55	
		LOM 99 ATEX		IEC 34-1	

Cast iron motors, sizes 80-132

ABB Motors					
3 - Mot. M2BA 132S2 A CI F IP 55 IEC34-1					
3GBA 131110-ASA / II 3 D T125°C					
6208/C3		6207/C3			
V	Hz	r/min	kW	cos φ	A
220-240 Δ	50	2920	5,5	0,89	18,5
380-420 Y	50	2920	5,5	0,89	10,7
No. 2909200603 / 1999					58 kg

ABB Oy, El.Machines					
LV Motors, Vaasa, Finland					
No. 3399998					
3~ M2BA 80 LS4 T125C V1					
r/min 1440		0.55 kW			
Cos φ 0.84/0.86		IP 65		CI F K	
V	Hz	A	Hz		
380 - 415 Y		11.7	50		
220 - 240 Δ		20.2	50		
3GBA 082310-BSB453					
6204-2Z/C3		24 kg			
LCIE 99 ATEX 6019 / 1999			IEC 60034-1		
				ABB	

Cast iron motors, sizes 160-355

ABB Oy, Electrical Machines					
LV Motors, Vaasa, Finland					
3~ Motor M3GP 280SMA 4 T125C B3					
IEC 280S/M 75					
S1		No. 3291111			
LJ-20964-1 / 2002		Ins. cl. F		IP 65	
V	Hz	kW	r/min	A	cos φ
690 Y	50	75	1484	78	0.86
400 D	50	75	1484	135	0.86
660 Y	50	75	1481	81	0.87
380 D	50	75	1481	140	0.87
415 D	50	75	1485	131	0.84
440 D	60	88	1780	141	0.87
Prod. code 3GGP282210-ADA453					
LCIE 02 ATEX 6028					
6315/C3		6316/C3		590 kg	
		ABB		IEC 60034-1	

Variant codes - DIP motors

Variant codes / DIP-motors		Aluminium motors				Cast iron motors				
Code ¹⁾	Variant	90-100	112-132	160-180	200-250	71-132 3D	80-132 2D	160-250	280-315	355
Balancing										
052	Balancing to grade R (ISO 2373).	P	P	P	P	P	P	P	P	P
417	Balancing to grade S (ISO 2373).	-	R	R	R	P	P	P	P	P
424	Full key balancing.	P	P	P	P	M	P	P	P	P
Bearings and lubrication										
036	Transport lock for bearings.	-	-	-	-	-	-	M	P	P
037	Roller bearing at D-end.	-	-	-	-	-	-	M	P	P
039	Cold resistant grease (-55...+100°C).	-	-	-	-	M	M	M	P	P
040	Heat resistant grease (-25...+150°C).	-	-	-	-	M	M	S	S	S
041	Bearings regreasable via grease nipples.	-	-	-	-	-	-	S	S	S
194	2Z-bearings at both ends, greased for lifetime.	-	-	-	-	S	S	M	R	-
042	Locked drive-end.	S	S	S	-	-	S	S	S	S
043	SPM-nipples.	-	P	P	P	-	-	S	S	S
058	Angular contact ball bearing at D-end, shaft force away from bearing.	-	-	-	-	-	-	P	P	P
107	Bearing mounted PT100 resistance elements.	-	-	-	-	-	-	P	P	P
433	Grease relief.	-	-	-	-	-	-	-	P	P
Brakes										
412	Built-on brake. Branch standard designs.	-	-	-	-	-	-	R	R	R
Branch standard designs										
142	"Manilla" winding connection. (440VD series, 220 VD parallel, 60 Hz).	-	-	-	-	-	-	P	P	P
178	Stainless steel/acid proof bolts.	P	P	P	P	M	S	M	P	P
209	Non-standard voltage or frequency (special winding).	R	R	R	R	R	R	P	P	P
411	Increased safety design.	-	-	-	-	-	-	R	R	R
425	Corrosion protected stator and rotor core.	R	R	R	-	-	-	S	P	P
Cooling system										
044	Unidirectional fan, clockwise seen from D-end.	-	-	-	-	-	-	-	R	R
045	Unidirectional fan, counter clockwise seen from D-end.	-	-	-	-	-	-	-	R	R
068	Metal fan.	S	S	S	S	S	S	S	S	S
075	Cooling method IC 418 (without fan).	R	R	R	R	R	R	P	P	P
183	Separate motor cooling (fan axial, N-end).	-	-	-	-	-	-	P	P	P
422	Separate motor cooling (fan top or side, N-end).	-	-	-	-	-	-	-	P	P
791	Stainless steel fan cover.	-	-	-	-	-	-	R	R	R
Coupling										
035	Assembly of customer supplied coupling-half.	-	-	-	-	M	M	M	M	M
Drain holes										
Note: DIP motors are equipped with drain holes in category 3D only.										
065	Plugged drain holes.	-	-	-	-	-	-	S	S	S
066	Modified drain hole position (for specified IM xxxx).	-	-	-	-	M	-	M	M	M
076	Draining holes with plugs.	-	-	-	-	-	-	S/-	S/-	S/-

¹⁾ Certain variant codes cannot be used simultaneously.

S = Included as standard.
M = On modification of a stocked motor, or on new manufacture, the number per order may be limited.

P = New manufacture only.
R = On request.
- = Not available

Variant codes / DIP-motors		Aluminium motors				Cast iron motors				
		90-100	112-132	160-180	200-250	71-132 3D	80-132 2D	160-250	280-315	355
Code ¹⁾	Variant									
Heating elements										
450	Heating element, 110-120 V.	R	R	R	R	M	M	M	M	M
451	Heating element, 220-240 V.	R	R	R	R	M	M	M	M	M
Insulation system										
014	Winding insulation class H.	-	-	-	-	-	-	R	P	P
405	Special winding insulation for frequency converter supply.	-	-	-	-	-	-	P	P	P
Mounting arrangements										
008	IM 2101 foot/flange mounted, IEC flange, from IM 1001 (B34 from B3).	-	-	-	-	M	P	-	-	-
009	IM 2001 foot/flange mounted, IEC flange, from IM 1001 (B35 from B3).	-	-	-	-	M	M	M	M	M
047	IM 3601 flange mounted, IEC flange, from IM 3001 (B14 from B5), flange mounted with large flange. Small flange with tapped holes.	-	-	-	-	M	M	-	-	-
Painting										
114	Special paint colour, standard grade.	P	P	P	P	M	M	M	M	M
111	Offshore two-pack polyamide cured epoxy paint 160 µm.	R	R	R	R	-	P	P	P	P
115	Offshore, zinc primer painting.	-	-	-	-	-	P	P	P	P
179	Special paint specification.	R	R	R	R	R	R	R	R	R
Protection										
005	Protective roof, vertical motor, shaft down.	M	M	M	M	M	M	M	M	M
072	Radial seal at D-end.	-	-	-	-	S	-	M	M	-
Rating & instruction plates										
002	Restamping voltage, frequency and output, continuous duty.	R	R	R	R	R	R	R	R	R
138	Mounting of additional identification plate.	M	M	M	M	M	M	M	M	M
139	Additional identification plate delivered loose.	M	M	M	M	M	M	M	M	M
150	Instruction plates and maintenance instructions in non-standard language.	-	-	-	-	R	R	R	R	R
161	Additional rating plate delivered loose.	M	M	M	M	M	M	M	M	M
Shaft & rotor										
069	Two shaft extensions as per basic catalogue.	P	P	P	P	-	P	P	P	P
070	One or two special shaft extensions, standard shaft material.	P	P	P	P	-	R	P	P	P
155	Cylindrical shaft extension, D-end, without key-way.	-	-	-	-	-	P	P	P	P
156	Cylindrical shaft extension, N-end, without key-way.	-	-	-	-	-	R	P	P	P
164	Shaft extension with closed key-way.	S	S	S	S	P	S	S	P	P
165	Shaft extension with open key-way.	-	-	-	-	S	P	P	S	S
410	Stainless/acid-proof steel shaft (standard or non-standard design).	P	P	P	P	-	-	P	P	P

¹⁾ Certain variant codes cannot be used simultaneously.

S = Included as standard.

M = On modification of a stocked motor, or on new manufacture, the number per order may be limited.

P = New manufacture only.

R = On request.
- = Not available

Variant codes / DIP-motors		Aluminium motors				Cast iron motors				
Code ¹⁾	Variant	90-100	112-132	160-180	200-250	71-132 3D	80-132 2D	160-250	280-315	355

Standards and regulations

152	Classified shaft material.	-	-	-	-	-	P	P	P	P
-----	----------------------------	---	---	---	---	---	---	---	---	---

Stator winding temperature sensors

121	Bimetal detectors, break type (NCC), (3 in series), 130°C, in stator winding.	-	-	-	-	-	P	P	P	P
122	Bimetal detectors, break type (NCC), (3 in series), 150°C, in stator winding.	-	-	-	-	-	P	P	P	P
125	Bimetal detectors, break type (NCC), (2x3 in series), 150°C, in stator winding.	-	-	-	-	-	P	P	P	P
127	Bimetal detectors, break type (NCC), (3 in series, 130°C and 3 in series 150°C), in stator winding.	-	-	-	-	-	P	P	P	P
435	PTC - thermistors (3 in series), 130°C, in stator winding.	P	P	P	P	M	P	M	M	M
436	PTC - thermistors (3 in series), 150°C, in stator winding.	S	S	S	S	S	S	S	S	S
439	PTC - thermistors (2x3 in series), 150°C, in stator winding.	P	P	P	P	P	P	P	P	P
441	PTC - thermistors (3 in series 130°C & 3 in series 150°C), in stator winding.	P	P	P	P	P	P	P	P	P
445	PT100 resistance element (1 per phase) in stator winding.	-	-	-	-	-	P	P	P	P
446	PT100 resistance element (2 per phase) in stator winding.	-	-	-	-	-	R	P	P	P

Terminal box

015	D connection in terminal box (reconnection from Y).	M	M	M	M	M	M	M	M	M
017	Y connection in terminal box (reconnection from D).	M	M	M	M	M	M	M	M	M
021	Terminal box LHS (seen from D-end).	-	-	-	-	-	-	P	P	P
136	Extended cable connection, standard terminal box. M2AA motors: 2 m long connection cable.	-	-	-	-	-	R	R	R	R
137	Extended cable connection, low terminal box.	-	-	-	-	-	P	P	P	P
157	Terminal box degree of protection IP 65.	-	-	-	-	M	S	M	M	M
180	Terminal box RHS (seen from D-end).	-	-	-	-	P	-	P	P	P
400	4 x 90 degr turnable terminal box. Cast iron sizes 200-250 = S	-	-	-	-	-	-	S	P	P
402	Terminal box adapted for Al -cables.	-	-	-	-	-	-	-	S	S
413	Extended cable connection, no terminal box.	-	-	-	-	-	-	-	P	P
418	Separate terminal box for temperature detectors.	-	-	-	-	-	-	M	P	P
466	Terminal box at N-end.	-	-	-	-	-	-	R	R	R
468	Non-standard cable entry direction (please state cable direction).	-	-	-	-	M	P	P	P	P
469	Axial cable entry direction.	-	-	-	-	M	P	P	P	P
731	Non-standard cable glands.	-	-	-	-	R	-	M	M	M
736	EEx e II certified cable gland, fulfilling EN 50014 and 50019 Eex d = -, Eex de = S	-	-	-	-	R	S	S	S	S
737	Standard cable gland, EEx e II with clamping device, fulfilling EN 50014 and 50019.	-	-	-	-	R	M	M	M	M
740	Prepared for PG cable glands.	-	-	-	-	P	-	P	P	P

¹⁾ Certain variant codes cannot be used simultaneously.

S = Included as standard.
M = On modification of a stocked motor, or on new manufacture, the number per order may be limited.

P = New manufacture only.
R = On request.
- = Not available

Variant codes / DIP-motors		Aluminium motors				Cast iron motors				
		90-100	112-132	160-180	200-250	71-132 3D	80-132 2D	160-250	280-315	355
Code ¹⁾	Variant									
Testing										
145	Type test report from test of identical motor.	R	R	R	R	M	M	M	M	M
146	Type test with report for motor from specific delivery batch.	R	R	R	R	M	P	M	P	P
147	Type test with report for motor from specific delivery batch, customer witnessed.	R	R	R	R	M	P	M	P	P
148	Routine test report.	R	R	R	R	M	M	M	P	P
221	Type test and multi-point load test with report for motor from specific delivery batch.	-	-	-	-	-	P	P	P	P
222	Torque/speed curve, type test and multi-point load test with report from specific delivery batch.	-	-	-	-	-	P	P	P	P
760	Vibration level test.	R	R	R	R	M	P	M	P	P
761	Vibration spectrum test.	R	R	R	R	P	P	P	P	P
762	Noise level test.	R	R	R	R	P	P	P	P	P
763	Noise spectrum test.	R	R	R	R	P	P	P	P	P
764	Complete test with ABB frequency converter.	-	-	-	-	P	P	P	P	P
Variable speed drives										
181	Adapted for frequency converter, variable speed operation.	-	-	-	-	R	R	R	R	R
405	Special winding insulation for frequency converter supply, rated supply > 500 V.	-	-	-	-	-	-	P	P	P
701	Insulated bearing at N-end. Note: In variable speed drives all Ex-motors size 280 and above must be equipped with insulated bearings.	-	-	-	-	-	-	R	P	P
704	EMC cable gland.	-	-	-	-	P	P	P	P	P
Separate cooling										
183	Separate motor cooling (fan axial, N-end).	-	-	-	-	-	-	P	P	P
422	Separate motor cooling (fan top or side, N-end).	-	-	-	-	-	-	-	P	P
Tacho										
747	EEx d pulse tacho.	-	-	-	-	-	-	P	P	P
Separate motor cooling & tacho										
476	Separate motor cooling (fan axial, N-end) and 1024 pulse tacho (Leine & Linde equivalent) mounted.	-	-	-	-	-	-	P	P	P
477	Separate motor cooling (fan axial, N-end) and 2048 pulse tacho (Leine & Linde equivalent) mounted.	-	-	-	-	-	-	P	P	P
Y/Δ-starting										
117	Terminals for Y/Δ start at both speeds (two-speed windings).	-	-	P	P	-	-	R	P	P
118	Terminals for Y/Δ start at high speed (two-speed windings).	-	-	-	-	-	-	R	P	P
119	Terminals for Y/Δ start at low speed (two-speed windings).	-	-	-	-	-	-	R	P	P

¹⁾ Certain variant codes cannot be used simultaneously.

S = Included as standard.
M = On modification of a stocked motor, or on new manufacture, the number per order may be limited.

P = New manufacture only.
R = On request.
- = Not available

Dimension drawings

Category 2 D & 3 D - DIP motors aluminium frame

Foot-mounted motor IM 1001, IM B3

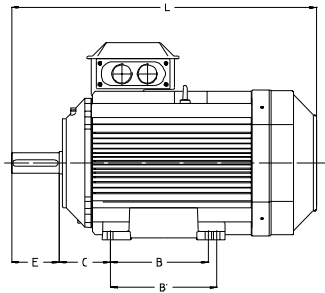

Flange-mounted motor IM 3001, IM B5

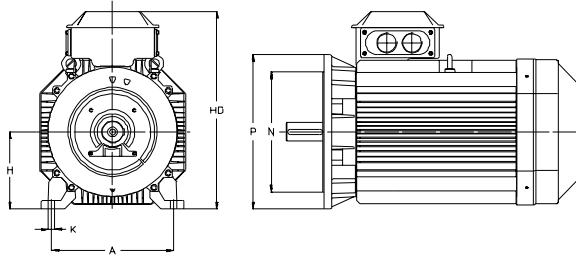

Shaft extension

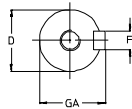

Flanges

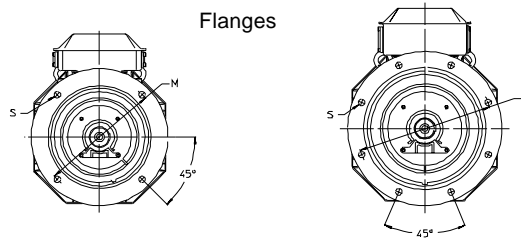

Sizes 90-180

Sizes 200-250

Motor size	IM 1001, IM B3 AND IM 3001, IM B5								IM 1001, IM B3						IM 3001, IM B5						
	D poles		GA poles		F poles		E poles		L max poles		A	B	B'	C	HD	K	H	M	N	P	S
	2	4-8	2	4-8	2	4-8	2	4-8	2	4-8											
90 S	24	24	27	27	8	8	50	50	295	295	140	100	—	56	212	10	90	165	130	200	12
90 L	24	24	27	27	8	8	50	50	320	320	140	125	—	56	212	10	90	165	130	200	12
100 L	28	28	31	31	8	8	60	60	358.5	358.5	160	140	—	63	236	12	100	215	180	250	15
112 M	28	28	31	31	8	8	60	60	361	361	190	140	—	70	258	12	112	215	180	250	14.5
132	38	38	41	41	10	10	80	60	447	447	216	140	178	89	295.5	12	132	265	230	300	14.5
160 M	42	42	45	45	12	12	110	110	602.5	602.5	254	210	254	108	368.5	15	160	300	250	350	19
160 L	42	42	45	45	12	12	110	110	643.5	643.5	254	210	254	108	368.5	15	160	300	250	350	19
180 M	48	48	51.5	51.5	14	14	110	110	680	680	279	241	279	121	403.5	15	180	300	250	350	19
180 L	48	48	51.5	51.5	14	14	110	110	700.5	700.5	279	241	279	121	403.5	15	180	300	250	350	19
200	55	55	59	59	16	16	110	110	773	773	318	267	305	133	496.5	18	200	350	300	400	19
225	55	60	59	64	16	18	110	140	835	865	356	286	311	149	542	18	225	400	350	450	19
250	60	65	64	69	18	18	140	140	872	872	406	311	349	168	590	22	250	500	450	550	19

Above table gives the main dimensions in mm.

For detailed drawings please check our web-pages
'www.abb.com/motors&drives' or contact ABB.

Dimension drawings

Category 2 D - DIP motors cast iron frame

Foot-mounted motor IM 1001, IM B3 Flange-mounted motor IM 3001, IM B5

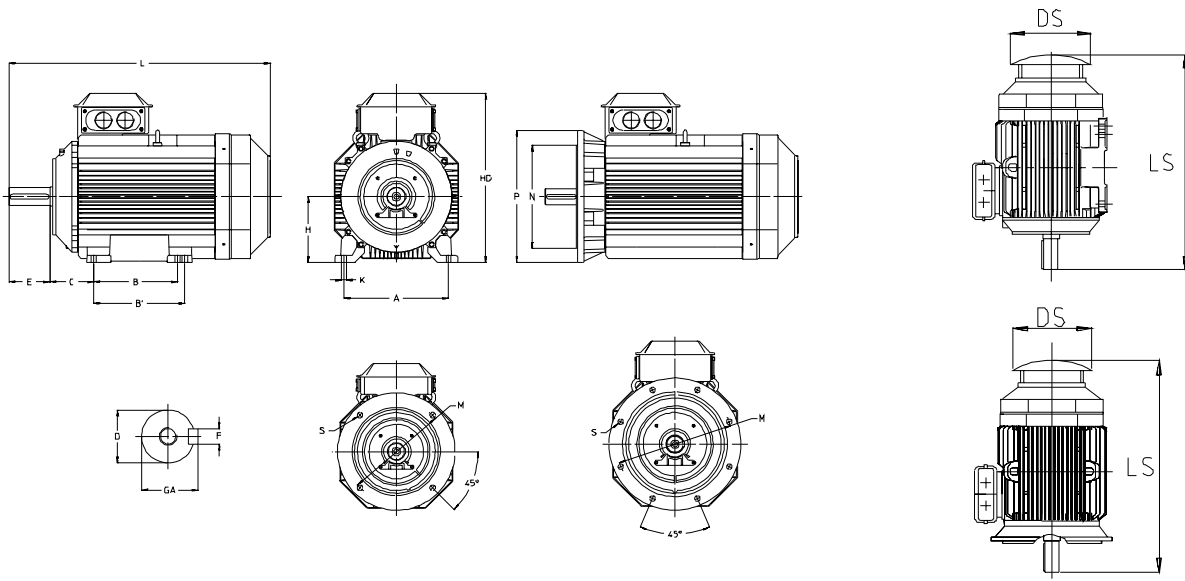

Sizes 71-200

Sizes 225-355

Protective roof,
variant code 005

Motor size	IM 1001, IM B3 AND IM 3001, IM B5								IM 1001, IM B3						IM 3001, IM B5				Protective roof					
	D poles		GA poles		F poles		E poles		L max poles		A	B	B'	C	H	HD	K	M	N	P	S	DS	LS poles	
	2	4-8	2	4-8	2	4-8	2	4-8	2	4-8											2	4-8		
80	19	19	21.5	21.5	6	6	40	40	287	287	125	100	-	50	80	250	9.5	165	130	200	11	150	306	306
90 S	24	24	27	27	8	8	50	50	336	336	140	100	125	56	90	275	9.5	165	130	200	11	170	360	360
90 L	24	24	27	27	8	8	50	50	336	336	140	125	125	56	90	275	9.5	165	130	200	11	170	360	360
100	28	28	31	31	8	8	60	60	399	399	160	140	-	63	100	294	11	215	180	250	13	188	444	444
112	28	28	31	31	8	8	60	60	419	419	190	140	-	70	112	306	11	215	180	250	13	188	444	444
132 S	38	38	41	41	10	10	80	80	512	512	216	140	178	89	132	351	11	265	230	300	14	255	548	548
132 M	38	38	41	41	10	10	80	80	512	512	216	178	178	89	132	351	11	265	230	300	14	255	548	548
160	42	42	45	45	12	12	110	110	711	711	254	210	254	108	160	388	14.5	300	250	350	18.5	328	756	756
180	48	48	51.5	51.5	14	14	110	110	706	706	279	241	279	121	180	426	14.5	300	250	350	18.5	359	756	756
200	55	55	59	59	16	16	110	110	774	774	318	267	305	133	200	536	18.5	350	300	400	18.5	414	844	844
225	55	60	59	64	16	18	110	140	841	871	356	286	311	149	225	583	18.5	400	350	450	18.5	462	921	951
250	60	65	64	69	18	18	140	140	875	875	406	311	349	168	250	646	24	500	450	550	18.5	506	965	965
280 SM	65	75	69	79.5	18	20	140	140	1088	1088	457	368	419	190	280	762	24	500	450	550	18	555	1190	1190
315 SM	65	80	69	85	18	22	140	170	1174	1204	508	406	457	216	315	852	30	600	550	660	23	624	1290	1320
315 ML	65	90	69	95	18	25	140	170	1285	1315	508	457	508	216	315	852	30	600	550	660	23	624	1401	1431
355 S	70	100	74.5	106	20	28	140	210	1344	1414	610	500	-	254	355	955	35	740	680	800	23	720	1476	1546
355 SM	70	100	74.5	106	20	28	140	210	1396	1466	610	500	560	254	355	955	35	740	680	800	23	720	1528	1703
355 ML	70	100	74.5	106	20	28	140	210	1501	1571	610	560	630	254	355	955	35	740	680	800	23	720	1633	1703

IM 3601, IM B14 - Available flange alternatives ; see also variant codes.

Flange size	Flange dimensions			Motor size						S = Standard flange R = Special flange NA = Not possible
	P	M	N	S	80	90	100	112	132	
FT100	120	100	80	M8	S	NA	NA	NA	NA	
FT115	140	115	95	M8	R	S	NA	NA	NA	
FT130	160	130	110	M8	R	R	S	S	NA	
FT165	200	165	130	M10	NA	NA	NA	NA	S	
FT215	250	215	180	M12	NA	NA	R	R	R	
FT265	300	265	230	M12	NA	NA	NA	NA	R	

Tolerances:

A, B	± 0,8
D, DA	ISO k6 < ∅ 50mm ISO m6 > ∅ 50mm
F, FA	ISO h9
H	+0 -0.5
N	ISO j6
C, CA	± 0.8

Above table gives the main dimensions in mm.
For detailed drawings please check our web-pages
'www.abb.com/motors&drives' or contact ABB.

Dimension drawings

Category 3 D - DIP motors cast iron frame

Foot-mounted motor IM 1001, IM B3 Flange-mounted motor IM 3001, IM B5

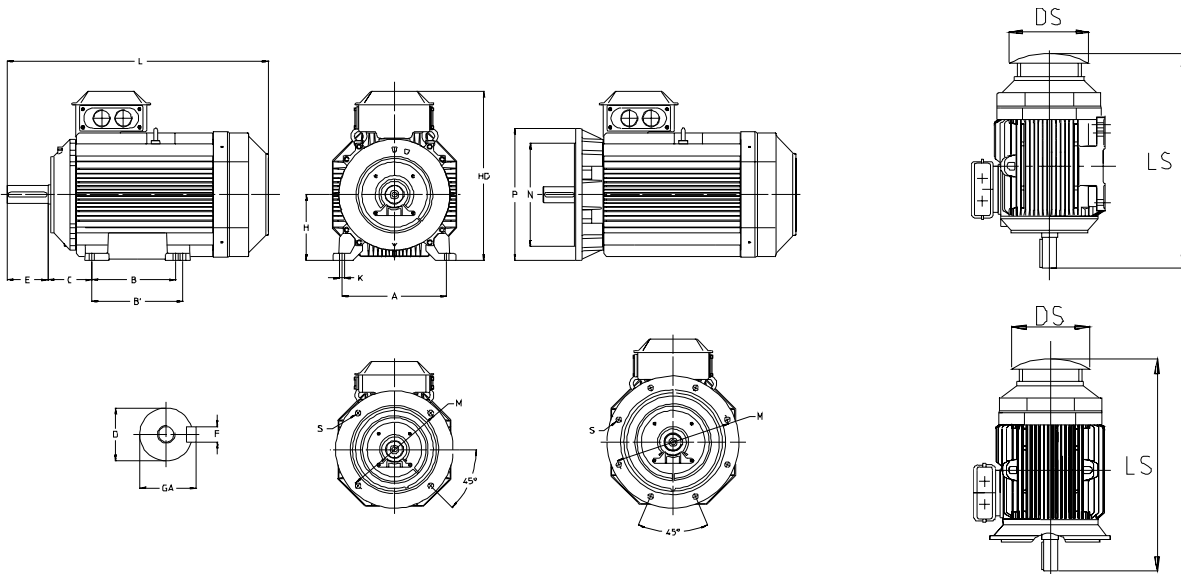

Sizes 71-200

Sizes 225-355

Protective roof, variant code 005

IM 1001, IM B3 AND IM 3001, IM B5								IM 1001, IM B3					IM 3001, IM B5				Protective roof							
Motor size	D poles		GA poles		F poles		E poles		L max poles	A	B	B'	C	HD	K	H	M	N	P	S	DS	LS poles		
	2	4-8	2	4-8	2	4-8	2	4-8														2	4-8	
71	14	14	16	16	5	5	30	30	250	250	112	90	-	45	190	7	71	130	110	160	10	140	275	275
80	19	19	21.5	21.5	6	6	40	40	282	282	125	100	-	50	220	10	80	165	130	200	12	155	320	320
90 S	24	24	27	27	8	8	50	50	310	310	140	100	-	56	235	10	90	165	130	200	12	175	345	345
90 L	24	24	27	27	8	8	50	50	335	335	140	125	-	56	235	10	90	165	130	200	12	175	370	370
100	28	28	31	31	8	8	60	60	380	380	160	140	-	63	270	12	100	215	180	250	15	195	410	410
112	28	28	31	31	8	8	60	60	395	395	190	140	-	70	290	12	112	215	180	250	15	220	425	425
132 S	38	38	41	41	10	10	80	80	462	462	216	140	-	89	330	12	132	265	230	300	15	260	490	490
132 M	38	38	41	41	10	10	80	80	500	500	216	178	-	89	330	12	132	265	230	300	15	260	530	530
160	42	42	45	45	12	12	110	110	711	711	254	210	254	108	388	14.5	160	300	250	350	18.5	328	756	756
180	48	48	51.5	51.5	14	14	110	110	706	706	279	241	279	121	426	14.5	180	300	250	350	18.5	359	756	756
200	55	55	59	59	16	16	110	110	774	774	318	267	305	133	573	18.5	200	350	300	400	18.5	414	844	844
225	55	60	59	64	16	18	110	140	841	871	356	286	311	149	620	18.5	225	400	350	450	18.5	462	921	951
250	60	65	64	69	18	18	140	140	875	875	406	311	349	168	683	24	250	500	450	550	18.5	506	965	965
280 SM	65	75	69	79.5	18	20	140	140	1088	1088	457	368	419	190	745	24	280	500	450	550	18	555	1190	1190
315 SM	65	80	69	85	18	22	140	170	1173	1203	508	406	457	216	840	30	315	600	550	660	23	624	1290	1320
315 ML	65	90	69	95	18	25	140	170	1224	1254	508	457	508	216	840	30	315	600	550	660	23	625	1341	1371
355 S	70	100	74.5	106	20	28	140	210	1344	1414	610	500	-	254	955	35	355	740	680	800	23	720	1476	1546
355 SM	70	100	74.5	106	20	28	140	210	1396	1466	610	500	560	254	955	35	355	740	680	800	23	720	1528	1703
355 ML	70	100	74.5	106	20	28	140	210	1501	1571	610	560	630	254	955	35	355	740	680	800	23	720	1633	1703

IM 3601, IM B14

Motor size	Flange size	P	M	N	S	T
71	C105	105	85	70	M6	2.5
71	C140	140	115	95	M8	3
80	C120	120	100	80	M6	3
80	C160	160	130	110	M8	3.5
90	C140	140	115	95	M8	3
90	C160	160	130	110	M8	3.5
100, 112	C160	160	130	110	M8	3.5
100, 112	C200	200	165	130	M10	3.5

Tolerances:

A, B	±0,8	H	+0-0.5
D, DA	ISO k6 < Ø 50mm	N	ISO j6
	ISO m6 > Ø 50mm	C, CA	±0.8
F, FA	ISO h9		

Above table gives the main dimensions in mm.

For detailed drawings please check our web-pages 'www.abb.com/motors&drives' or contact ABB.

Frequency converter drive and hazardous areas

Motors with protection types EEx d, EEx de, Ex nA, EEx nA and dust ignition proof (with cast iron frame) are designed and certified for variable speed drives.

When using a squirrel cage Ex-motor with a frequency converter, the following points must be taken into account, in addition to the general selection criteria.

A. Safety criteria

These criteria are imposed by the competent bodies in order to secure the use of motors with inverters in hazardous areas.

1. Type tests and certification

Type tests according to the test procedure imposed by the Ex notified bodies of a representative number of motors with converters are available by ABB.

ABB has type tested and certified at LCIE the complete range of Ex nA, EEx nA, Ex N, EEx d, EEx de and DIP (cast iron) so that in respect with the following conditions according to points 2 and 3 below no more individual type tests are needed.

2. Dimensioning

The voltage (or current) fed by the frequency converter is not purely sinusoidal. This may increase the losses, vibration, and noise of the motor. Further-more, a change in the distribution of the losses may affect the motor temperature balance and lead to an increase in the temperature of the bearings. In every case, the motor must be correctly sized according to the instructions supplied with the selected frequency converter (see loadability curve next page).

When using ABB converters use the DriveSize dimensioning programme or "ISOTHERM GUIDE-LINES" of the corresponding converter type for sizing the motors.

3. Critical parameters to indicate on the motor

In a frequency converter drive, the actual operating speed of the motor may deviate considerably from its nominal speed (i.e. the speed stamped on the rating plate). For higher speeds, ensure that the highest permissible rotational speed of the motor or the critical speed of the entire equipment, is not exceeded.

In addition, bearing lubrication and any ventilation noise suppression arrangements will require special attention. The maximum speed of Ex-motors must also be checked since the EN standard determines some speed limits for the cooling equipment and for the minimum gap between rotor and stator.

Permissible maximum speeds are described in figure 1 below. More precise values available from ABB.

Figure 1. Maximum permissible speeds

Frame size	Speed r/min	
	2-pole	4-pole
71-200	4000	3600
225-280	3600	2600
315	3600	2300
355	3600	2200
400	3600	1800

4. Thermal protection

All ABB Ex-motors are equipped with PTC thermistors or as option for EEx d and EEx de motors bi-metal switches.

5. Rating plates

There will be an other rating plate indicating the essential speed duty parameters:

- speed range
- power range
- voltage & current range
- type of torque (constant or quadratic)
- converter setting (switching frequency FSW)



 0081		ABB Oy, Electrical Machines LV Motors, Vaasa, Finland	
3~Motor M3JP 250SMA 4 EExd IIB T4 B3			
IEC 250S/M 65			
S1		No. 3492820	
LJ-20964-1 / 2001		Ins.cl. F	IP 55
V	Hz	kW	r/min
690 Y	50	55	1479
400 D	50	55	1479
660 Y	50	55	1475
380 D	50	55	1475
415 D	50	55	1480
440 D	60	63	1775
Prod.code 3GJP252210-ADG138148			
LCIE 00 ATEX 6030			
6315/C3		6313/C3	450 kg
 II 2D		A B B IEC 60034-1	

ABB Oy, Electrical Machines LV Motors, Vaasa, Finland						
3~Motor M3JP 250SMA 4 EExd IIB T4						
No. 3492820						
CONVERTER SUPPLY						
FC Type: ACS 600						
Switch.freq.: > 3 KHz						
F.W.P. 400 VD 50 Hz						
V	Hz	kW	r/min	A	cos φ	DUTY
400	50	44	1483	87		S9
80	10	8.4	281	90		S9
CONSTANT TORQUE 10-50 Hz T:284Nm						
A B B						

B. Technical criteria

1. Lubrication

The effectiveness of the motor lubrication should be checked by measuring the surface temperature of bearing endshields under normal operating conditions. If the measured temperature is +80°C or above, the relubrication intervals specified in ABB's standard instruction manuals must be shortened; i.e. the relubrication interval should be halved for every 15 K increase in bearing temperature. If this is not possible ABB recommends the use of lubricants suitable for high operating temperature conditions. These lubricants allow a normal relubrication interval and 15 K increase in bearing temperature conditions.

2. Insulation protection

Frequency converters, based on IGBT power components, cause higher voltage stress on the windings of the motor due to rapid switchings and reflections in the cables than sinusoidal supply voltage. Therefore the precautions described in table 1 below must be taken to protect the winding of the motor.

For GTO converters, please contact ABB.

Note: ABB does not recommend increased safety EEx e motors for VSD applications.

3. Bearing currents

Depending on shaft height and network voltage supply, bearing currents and voltages must be avoided in Ex-motors. In such cases insulated bearings or a properly dimensioned filter at the converter output must be used acc. to instructions in table 1 below. When ordering clearly state which alternative will be used.

4. EMC

For fulfilling the EMC requirements, special EMC cable(s) must be used in addition to the correct cable gland mounting, with special, extra earthing pieces (variant code 704). Note that you must use only symmetrical shielded cables.

Correct earthing of the motor and the driven equipment is important to avoid bearing voltages and currents.

Table 1. Selection rules for insulation in variable speed drives

	Motor frame size < IEC 250	≥ IEC 280	≥ IEC 355
$U_N \leq 500$ V	Standard Ex-motor	Standard Ex-motor + Insulated N-bearing	Standard Ex-motor + Insulated N-bearing + Common mode filter
$U_N \leq 600$ V	Standard Ex-motor + dU/dt-filter OR Reinforced insulation	Standard Ex-motor + dU/dt-filter + Insulated N-bearing OR Reinforced insulation + Insulated N-bearing	Standard Ex-motor + Insulated N-bearing + dU/dt-filter + Light Common mode filter OR Reinforced insulation + Insulated N-bearing + Common mode filter
$U_N \leq 690$ V	Reinforced insulation + dU/dt-filter	Reinforced insulation + dU/dt-filter + Insulated N-bearing	Reinforced insulation + Insulated N-bearing + dU/dt-filter + Light common mode filter

dU/dt filter

Series reactor. dU/dt decrease the changing rate of the phase and main voltages and thus reduce voltage stresses in the windings. dU/dt filters also decrease so called common mode currents and bearing currents.

Common mode and light common mode filters

Common mode filters are made of toroidal cores installed around motor cables. These filters reduce so called common mode currents in VSD applications and thus decrease the risk of bearing currents. Common mode filters do not significantly affect on the phase or main voltages on the motor terminals.

Common Mode Filter = 3 toroidal cores per each 3-phase motor cable

Light Common Mode Filter = 1 toroidal core per each 3-phase motor cable

Motor loadability with ACS 600

The loadability curve below is a guide line curve, for exact values please contact ABB. The curves below are valid for converters manufactured by ABB, they are basic rules and ABB reserves the right to changes. For use with converters others than from ABB, you can consult ABB.

Please note that the curve is according to temperature rise B; class F temperature rise is not allowed.

Figure 2. Motor loadability with ACS 600

Flameproof motors EEx d/EEx de T4 (50 Hz)

- corresponding curve for temperature class T5 and T6 on request

Non-sparking motors Ex nA, EEx nA, Ex N (50 Hz), frame sizes 71-132

Dust ignition proof cast iron motors T125 (50 Hz), frame sizes 71-355

Non-sparking motors Ex nA, EEx nA, Ex N (50 Hz), frame sizes 160-400

The loadability curves below assume the nominal frequency of the motor e.g. field weakening point is at 50 Hz. The loadability curve from 0 to 5 Hz is only valid in case of use a DTC control.

If needed please contact us to get more information. Values in table format are available from ABB on request.

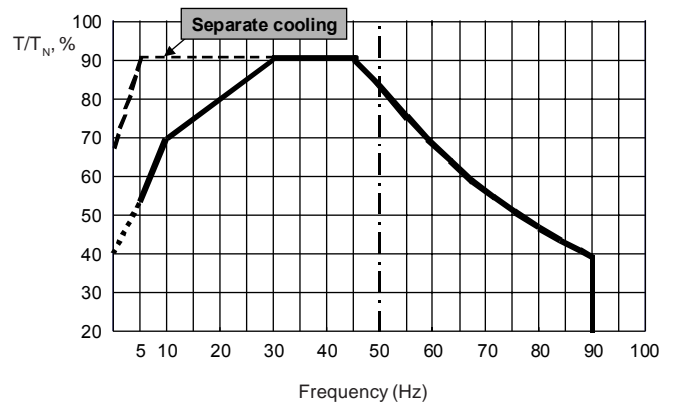
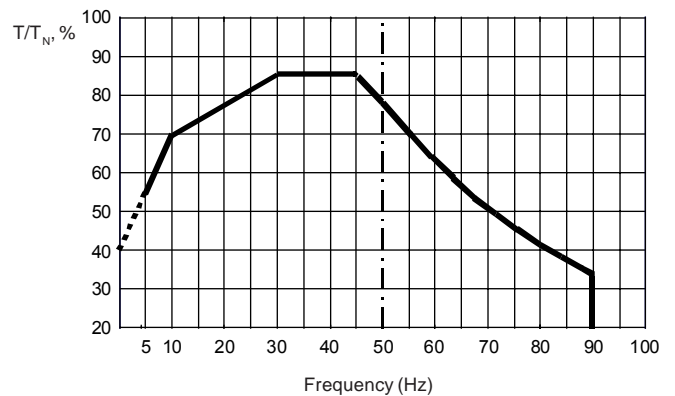
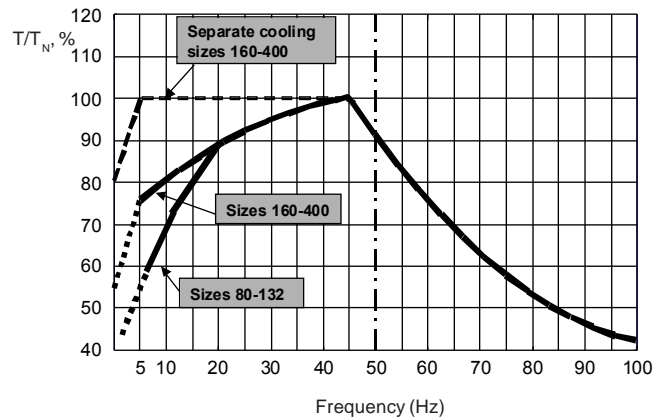

M3000 Motors for demanding industries

General design

- Standardized motors to meet IEC recommendations and CENELEC standards
- Corrosion and weather protected motors
- Offshore application: IP 55 or IP 56 on request
- Frame material: cast iron
- Insulation: class F
- Temperature rise: according class B
- High overload capacity: $T_{max} / T_N > 1.8$
- Accelerating torque: $> 10\%$
- High starting performance
- Low noise level: $< 85 \text{ dB(A)}$
- Design for variable speed applications

Safety of goods and personnel

- Explosion protection required :

Standard	Ex nA, EEx nA	EEx e	EEx d	EEx de
Yes	Yes	Yes	Yes	Yes

Variable speed applications

- EEx d, EEx de -motors are certified with included thermistors. A separate rating plate shows the regulation field and torque characteristics.
- EEx nA, Ex nA, Ex N -motors certified

Corrosion protection when needed

- Stainless steel screws
- Stainless steel grease nipples
- Stainless steel rating plates
- Corrosion resistant drain hole plug
- Radial seal, V-ring
- Fan made of reinforced glass fiber laminate
- 2 layers coating epoxy paint system
- Steel fan cover with epoxy coating
- Rotor and stator core corrosion protected

Interchangeability

- IEC output
- Network: 50 Hz or 60 Hz
- Large capacity of cable entries
- Double fixation holes on the majority of foot-mounted motors
- One earthing bolt in the terminal box and one on the frame as option
- Jacking bolts to make coupling easier as option
- Balancing full key or half key available as option

Running efficiency

- High efficiency motors and minimum power factor requested
- Efficiency corresponding to highest EU efficiency levels eff1
- Winding protection as option; PTC or PT100
- Grease nipples as option
- SPM nipples as option
- Motors sizes 71 - 315 equipped with same bearings at both ends
- Balancing close to class R
- Bearing lifetime L_{10} , 40.000 h
- Bearing temperature rise max. $+55^\circ\text{C}$

Approved design for specifications

- EEMUA (Engineering Equipment and Materials Users Association) - Variant code 773
- NORSOK (North Sea Territorial Waters) - Variant code 774
- SHELL DEP 33.66.05.31 - Gen, January 1999 - Variant code 775
- UIC (Union des Industries Chimiques) - Variant code 787
- VIK (Verband der industriellen Energie- und Kraftwirtschaft e.V.) - Variant code 421

Specification

Motors acc. to VIK (Verband der industriellen Energie- und Kraftwirtschaft e.V.) – Variant code 421

General design for demanding industries

- Standardized motors to meet IEC recommendations and CENELEC standards
- Frame material: cast iron
- Insulation: class F
- Temperature rise: according class B
- Low noise level: < 77 dB(A) (+3 dB(A) tolerance)
- Degree of protection: Min. IP 54

Safety of goods and personnel

- Explosion protection availability:

Standard	Ex nA, EEx nA	EEx e	EEx d	EEx de
Yes, practically Ex nA	Yes	Yes	No	Yes

Corrosion protection

- Stainless steel rating plates
- Fan made of reinforced glass fiber laminate or aluminium
- Heavy industry paint system (70 µm epoxy)

Interchangeability

- Nominal voltages 380-400-415 V; voltage 420 V On request
- IEC output and dimensions
- Shaft dimension requirements for 315, 355 and 400
- Wide range voltage up to frame size 250
- Stamping of 'VIK' on rating plate
- Additional rating plate in terminal box
- Prepared for mounting of customer identification plate
- Stamping of weight for motors above 30 kg
- Drainage hole in flange for IM V3
- Plugs in unused fixation holes on foot-mounted motors
- Drainage holes, when provided, must be closed
- Terminal box 90° turnable without turning terminal board
- Terminal box with gland plate from size 200
- Split terminal box from size 315
- Undetachable screws in terminal box cover
- Earthing terminal on frame
- Half key balanced
- EEx e up to size 200 (incl.): one rating plate for T1/T2 and one for T3
- Minimum $t_E = 7$ sec for EEx e

Running efficiency

- Nominal bearing life³ 40000 h in coupling
- Regreasable bearings available from size 250
- Button head grease nipples acc. to DIN 3404
- Grease intervals (amb. temp. 40°C) for 2 pole motors: min. 2000 h
- Grease intervals (amb. temp. 40°C) for 4-12 pole motors: min. 4000 h

Service

- Stock availability

Specifications approved for operations by:

- Amoco
- Basf
- Bayer
- Degussa
- Dow Chemical
- CSM
- Henkel
- Hoechst
- Merck
- Schering
- Veba Oil

Certificates

Example of certification of flameproof motors with CE-marking acc. to directive 94/9/EC



1 ATTESTATION D'EXAMEN CE DE TYPE

2 Appareils et systèmes de protection destinés à être utilisés en atmosphères explosibles
Directive 94/9/CE

3 Numéro de l'attestation CE de type
LCIE 02 ATEX 6028

4 Appareil ou système de protection
Moteur asynchrone
Type : M3GP 280... et M3GP 315...

5 Demandeur : ABB OY, Electrical Machines, LV Motors

6 Adresse : PO Box 633
Strömbergin Puistotie 5A
65101 VAASA FINLANDE

7 Cet appareil ou système de protection et ses variantes éventuelles acceptées est décrit dans l'annexe de la présente attestation et dans les documents descriptifs cités en annexe.

8 Le LCIE, organisme notifié sous la référence 0081 conformément à l'article 9 de la directive 94/9/CE du Parlement européen et du Conseil du 23 mars 1994, certifie que cet appareil ou système de protection est conforme aux exigences essentielles en ce qui concerne la sécurité et la santé pour la conception et la construction d'appareils et de systèmes de protection destinés à être utilisés en atmosphères explosibles, données dans l'annexe II de la directive. Les vérifications et épreuves figurent dans notre rapport confidentiel N° 38 334 010 0010 A.

9 Le respect des exigences essentielles en ce qui concerne la sécurité et la santé est assuré par la conformité aux documents suivants :
- EN 50014 (1997)
- EN 50281-1-1 (1998)
- EN 50021 (1999)

10 Le signe X lorsqu'il est placé à la suite du numéro de l'attestation, indique que ce matériel ou système de protection est soumis aux conditions spéciales pour une utilisation sûre, mentionnées dans l'annexe de la présente attestation.

11 La présente attestation d'examen CE de type porte uniquement sur la conception, l'examen et l'essai de l'équipement ou du système de protection spécifiée conformément à la directive 94/9/CE.
Toutes autres exigences de la Directive sont applicables au procédé de fabrication et de livraison de cet équipement ou système de protection. Ces derniers ne sont pas couverts par la présente attestation.

12 Le marquage de l'appareil ou du système de protection devra comporter, entre autres indications utiles, les mentions suivantes :

 II 2 D et/ou 3G et/ou 3D
EEx nA II T1, T2 ou T3
IP 6X/5X, T ... °C (ex : T 120 °C, T 125 °C)

1 EC TYPE EXAMINATION CERTIFICATE

2 Equipment or Protective System Intended for use in Potentially explosive atmospheres
Directive 94/9/CE

3 EC type Examination Certificate number
LCIE 02 ATEX 6028

4 Equipment or Protective system
Asynchronous motor
Type : M3GP 280... and M3GP 315...

5 Applicant : ABB OY, Electrical Machines, LV Motors

6 Address : PO Box 633
Strömbergin Puistotie 5A
65101 VAASA FINLAND

7 This equipment or protective system and any acceptable variation thereto is specified in the schedule to this certificate and the documents therein referred to.

8 LCIE, notified body number 0081 in accordance with article 9 of the directive 94/9/CE of the European Parliament and Council of 23 March 1994, certifies that this equipment or protective system has been found to comply with the Essential Health and Safety Requirements relating to the design and construction of equipment and protective system intended for use in potentially explosive atmospheres, given in Annex II to the directive.
The examination and test results are recorded in confidential report No 38 334 010 0010 A.

9 Compliance with the Essential Health and Safety Requirements has been assured by compliance with :
- EN 50014 (1997)
- EN 50281-1-1 (1998)
- EN 50021 (1999)

10 If the sign X is placed after the certificate number, it indicates that the equipment or protective system is subject to special conditions for safe use specified in the schedule to this certificate.

11 This EC Type examination certificate relates only to the design, examination and tests of the specified equipment or protective system in accordance to the directive 94/9/EC.
Further requirements of the Directive apply to the manufacturing process and supply of this equipment or protective system. These are not covered by this certificate.

12 The marking of the equipment or protective system shall include the following :

 II 2 D and/or 3G and/or 3D
EEx nA II T1, T2 or T3
IP 6X/5X, T ... °C (ex : T 120 °C, T 125 °C)

Fontenay-aux-Roses, le 04 mars 2002

Le Directeur de l'organisme certificateur
Manager of the certification body

Jean-Pierre GOMEL
Président et directeur général

Timbre sec/dry seal

Page 1/3

Seul le texte en français peut engager la responsabilité du LCIE. Ce document ne peut être reproduit que dans son intégralité, sans aucune modification.
The LCIE's liability applies only on the French text. This document may only be reproduced in full and without any change.

LABORATOIRE CENTRAL DES INDUSTRIES ELECTRIQUES



Société anonyme à Directoire et Conseil de surveillance au capital de 15 745 984 euros - RCS Nanterre B 408 363 174

33, avenue du Général Leclerc - BP n° 8 - F 92266 FONTENAY-AUX-ROSES CEDEX - Tél. : +33 1 40 95 60 60

13-c

Certificates



Example of a EC Declaration of Conformity



3(2)

2002-03-11

Certificates: 3-phase induction motors, series MQBA, MQJA, MQKA, MQJP, MQNP, MQDB, MQHP

Series & category, temperature class, protection	Motor type, IEC frame size	Certificate number	Year of CE marking	Notified Body or Manufacturer	
Flameproof S2 D, CC:4 T1-T6 S2 D, CC:4H T1-T6 S2 D, T1-T6 IP 65, (EN 60 529)	MQJAMQA 80	LCB 99-ATEX-0020	1999	ExNB - LCB (0001)	
	MQJAMQA 90	LCB 99-ATEX-0020	1999	ExNB - LCB (0001)	
	MQJAMQA 100-112	LCB 99-ATEX-0022	1999	ExNB - LCB (0001)	
	MQJAMQA 132	LCB 99-ATEX-0010	1999	ExNB - LCB (0001)	
	MQJAMQA 160	LCB 99-ATEX-0010	2000	ExNB - LCB (0001)	
	MQJAMQA 180	LCB 99-ATEX-0023	1999	ExNB - LCB (0001)	
	MQJAMQA 200	LCB 99-ATEX-0023	2000	ExNB - LCB (0001)	
	MQJAMQA 225	LCB 99-ATEX-0023	1999	ExNB - LCB (0001)	
					ExNB - LCB (0001)
					ExNB - LCB (0001)



1(2)

EC Declaration of Conformity

The Manufacturer: ABB Oy
Electrical Machines, LV Motors
P.O. Box 633
Strömbergin puistikko 5A
FIN - 05101 Vaasa, Finland

hereby declares that:

The Products: 3-phase induction motors, series MQBA, MQJA, MQKA, MQJP, MQNP, MQDB and MQHP, as listed on page 2, in this document are in conformity with provisions of the following Council Directives:

ATEX of 23 March 1986 94/9/EC

In respect of category :
Harmonized standards : EN 50 014, EN 50016, EN 50 019, EN 500 21, EN 50 281 - 1 - 1, EN 50 281 - 1 - 2

Low Voltage Directive 73/23/EEC (amended by 93/68/EEC),
and, as components, with the essential requirements of the following :

EMC Directive 89/336/EEC (amended by 92/31/EEC and 93/68/EEC), regarding the intrinsic characteristics to emission and immunity levels,
and are in conformity with : EN 60 534-1

Additional information :-
By design, the machines, considered as components, comply with the essential requirements of
Machinery Directive 90/269/EEC, provided that the installation be correctly realized by the manufacturer of the machinery (for example : in compliance with our installation instructions and EN 60 204 "Electrical Equipment of Industrial Machines").

Certificate of Incorporation (Directive 88/37/EEC, Art 4.2 and Annex I, Sub B) :

The machines above must not be put into service until the machinery into which they have been incorporated have been declared in conformity with the Machinery Directive.

Signed by 
Jussi Hänninen
Title: Product Development Manager
Date: March 11, 2002



Hubertus Häike
Title: Product Manager for Ex-motors

ABB Oy

Electrical Machines, LV Motors Postal address P.O. Box 633 FIN-05101 Vaasa FINLAND	Vailing Address Strömbergin Puistikko 5 A FIN-05100 Vaasa FINLAND	Telephone +359 18 22 11 Telefax +359 18 22 47372	Internet www.abb.fi e-mail [first name last name] @fi.abb.com	Business Identity Code 0642134-0 Domicile: Helsinki
---	--	---	---	---

Business Identity Code:
0642134-0
Domicile: Helsinki

Certificates

Example of certification of Dust ignition proof motors

	LABORATORIO OFICIAL J.M. MADARIAGA	
(1)	CERTIFICADO DE EXAMEN CE DE TIPO	
(2)	Equipos y sistemas de protección destinados a ser utilizados en atmósferas potencialmente explosivas. Directiva 94/9/CE	
(3)	Número del Certificado de Examen CE de Tipo	LOM 99ATEX2024
(4)	Equipo o sistema de protección	Motores eléctricos para polvo serie MBT Tipos MBT 200, MBT 225 y MBT 250
(5)	Solicitante	ABB Motores, S.A.
(6)	Dirección	Polígono Industrial de S.O. 08192-SANT QUIRZE DEL VALLÈS BARCELONA (ESPAÑA)
(7)	Este equipo o sistema de protección y sus variantes eventualmente aceptadas está descrito en el anexo del presente certificado y en los documentos descriptivos citados en dicho anexo	
(8)	El Laboratorio Oficial J.M. Madariaga (LOM), organismo notificado bajo la referencia nº 0163, conforme al artículo 9 de la Directiva 94/9/CE del Parlamento Europeo y del Consejo del 23 de Marzo de 1994, certifica que este equipo o sistema de protección es conforme a los Requisitos Esenciales de Seguridad y Salud relativos al diseño y construcción de equipos y sistemas destinados a ser utilizados en atmósferas potencialmente explosivas, indicados en el Anexo II de la Directiva. La verificaciones y ensayos se recogen en el protocolo confidencial LOM 99.083 XP	
(9)	El cumplimiento con los Requisitos Esenciales de Seguridad y Salubridad está basado en la conformidad a los siguientes documentos: - Normas EN 50014:1997 EN 50281-1-1:1998	
(10)	Si el signo X aparece después del número de certificado indica que este material o sistema de protección está sometido a las condiciones especiales de utilización que figuran en el anexo del presente certificado.	
(11)	Este Certificado de Examen CE de Tipo se refiere únicamente al diseño y construcción del equipo o sistema de protección especificado, conforme a la Directiva 94/9/CE. Son aplicables exigencias suplementarias de esta Directiva para la fabricación y suministro de este equipo o sistema de protección.	
(12)	El marcado del equipo o sistema de protección deberá incluir, entre otras indicaciones relevantes, lo siguiente: 	
	 Carlos Fernández Ramón DIRECTOR DEL LABORATORIO	 OFICIAL LABORATORIO OFICIAL J.M. MADARIAGA Madrid, 11 de Junio de 1999  Angel Vega Remesal Responsable del área ATEX
<i>(Este documento solo puede reproducirse íntegramente y sin cambio alguno)</i>		Pág. 1/3
	MINISTERIO DE INDUSTRIA Y ENERGÍA • MINISTERIO DE EDUCACIÓN Y CIENCIA ENSAYOS E INVESTIGACIONES DE MATERIALES Y EQUIPOS PARA ATMÓSFERAS EXPLOSIVAS Y MINERÍA (Real Decreto 334/1992 de 3 de Abril - BOE 1992-04-29 -)	
Aénza. 2 - 28005-MADRID • ☎ (34) 91 4421366/ 91 3367009 • Fax.(34) 91 4419933 • ✉ lom@dse.upm.es		

ABB High Voltage motor's product offer for hazardous areas

Flameproof motors

Type of protection: EEx d IIB/IIC T4, EEx de, IIB/IIC T4

Features: LV-11kV, 50/60 Hz, 2-18 poles, VSD applications, IP55, IC411, IC511, Horizontal or Vertical

Motor type	IEC frame size	Output kW
Ribs cooled	355 - 500	150 - 1250 kW
Tubes cooled	500 - 710	800 - 4500 kW

Pressurised motors

Type of protection: Ex p, EEx p, Ex pe, EEx pe; Temperature classes T1-T4, Gas groups A, B and C

Features: 50/60 Hz, 2-24 poles, VSD applications, acc. to ATEX Directive and IEC standards

Motor type	IEC frame size	Output kW
Induction motors	315 - 1120	up to 18 MW (24000 HP)
Synchronous motors	710 - 1250	up to 55 MW (74000 HP)

Increased safety motors

Type of protection: Ex e, EEx e, Temperature classes T1-T3, Gas groups A, B and C

Features: 50/60 Hz, 2-24 poles, VSD applications, acc. to ATEX Directive and IEC Standards

Motor type	IEC frame size	Output kW
Induction motors	315 - 1120	up to 10 MW (13410 HP)

Non-sparking motors

Type of protection: Ex nA, EEx nA, T1-T4, Gas groups A,B and C

Features: 50/60 Hz, 2-24 poles, VSD applications, acc. to ATEX Directive and IEC Standards, CSA/UL certified

Motor type	IEC frame size	Output kW
Induction motors	315 - 1120	up to 18 MW (24000 HP)
Synchronous motors	500 - 1250	up to 55 MW (74000 HP)

Motors for North America (NEC and CEC)

Type of protection: Class I Division 2, Class I Zone 2, Class II Division 2, Class III; T1-T4

Features: 50/60 Hz, 2-24 poles, VSD applications, designed for North American markets, CSA/UL-certified

Motor type	IEC frame size	Output kW
Induction motors	315 - 1120	up to 18 MW (24000 HP)
Synchronous motors	710 - 1250	up to 55 MW (74000 HP)

More information for these motors
can be found from web-pages:

www.abb.com/motors&drives

ABB Low Voltage Motors' total product offer

M2000 range

Motor type	IEC frame size	Output kW
Aluminium motors	56 - 132	0.055 - 7.5 kW
Cast iron motors	71 - 315	0.25 - 200 kW

M3000 range

Motor type	IEC frame size	Output kW
Aluminium motors	56 - 280	0.055 - 95 kW
Cast iron motors	71 - 400	0.25 - 710 kW
Steel motors	280 - 400	75 - 630 kW
Hazardous area motors	71 - 400	0.25 - 630 kW
Marine motors	56 - 400	0.06 - 630 kW
Open drip proof motors (IP 23)	250 - 400	75 - 800 kW
Brake motors	63 - 160	0.18 - 15 kW
	NEMA frame size	Output HP
NEMA motors	404 - 587	100 - 700 HP

Special types/alternatives

- high speed motors, over 3000 r/min
- motor adjusted with a holding brake
- wind turbine generators
- motors for roller table drives
- water cooled motors
- smoke venting design
- single-phase motors
- fan application motors
- slip-ring motors
- stator/rotor units

Catalogues and brochures for these motors are available from:

ABB
Electrical Machines
BA Marketing communications
P.O.Box 633
FIN-65101 Vaasa
tel. +358 (0) 10 22 11
fax +358 (0) 10 22 43575
www.abb.com/motors&drives

Ordering information

Sample order

When placing an order, the motor type, size and product code must be specified. The product code of the motor is composed in accordance with the following examples.

A	B	C	D, E, F								G
M3JP	160 M	3GJP	162	300	-	A	D	A	003	etc.	
		1-4	5-6	7	8-10	11	12	13	14		

A Motor type
B Motor size
C Product code
D Mounting arrangement code
E Voltage and frequency code
F Generation code
G Variant codes

Description of the product code:

Positions 1 - 4

- 3GAA** = Totally enclosed motor with aluminium frame
3GBA = Totally enclosed motor with cast iron frame
3GJP = Totally enclosed frameproof motor EE xd with cast iron frame
3GKP = Totally enclosed flameproof motor EEx de with cast iron frame

Positions 5 and 6

IEC-frame size

06 = 63	10 = 100	18 = 180	28 = 280
07 = 71	11 = 112	20 = 200	31 = 315
08 = 80	13 = 132	22 = 225	35 = 355
09 = 90	16 = 160	25 = 250	40 = 400

Position 7

Speed (pole pairs)

1 = 2 poles	4 = 8 poles	7 = 12 poles
2 = 4 poles	5 = 10 poles	8 = Two-speed motors
3 = 6 poles	6 = 12 poles	9 = Multi-speed motors

Position 8-10

Running number series

Position 11 - (Dash)

Position 12

Mounting arrangement

- A** = Foot-mounted, top mounted terminal box
R = Foot-mounted, terminal box RHS seen from D-end
L = Foot-mounted, terminal box LHS seen from D-end
B = Flange-mounted, large flange with clearance holes
C = Flange-mounted, small flange with tapped holes
V = Flange-mounted, Special flange
H = Foot/flange-mounted, large flange with clearance holes
J = Foot/flange-mounted, small flange with tapped holes
S = Foot/flange-mounted, terminal box RHS seen from D-end
T = Foot/flange-mounted, terminal box LHS seen from N-end
F = Foot/flange-mounted, special flange

Position 13

Voltage/frequency code

See tables on the technical data pages.

Position 14

Generation code

A, B, C...

Generation code is followed by variant codes according to the hazardous area, see below and on corresponding pages with variant codes:

094	Ex nA design acc. to IEC 79-15, Ex N acc. to BS 5000/16
097	EEx e design
407	Ex N design, fulfilling BS 5000/16, certif. provided
455	Ex N design, fulfilling BS 5000/16, without certif.
456	Ex nA design, fulfilling IEC 79-15, certif. provided
457	Ex nA design, fulfilling IEC 79-15, without certif.
480	EEx nA fulfilling EN 50021.
458	EEx e design, fulfilling EN 50014 and EN 50019
273	EEx e design, temperature class T3
274	EEx e design, temperature class T4
275	EEx e design, temperature class T5
276	EEx e design, temperature class T6
461	EEx d(e) design, Group IIC
462	EEx d(e) design, temperature class T5
463	EEx d(e) design, temperature class T6
452	DIP according to EN 50281-1, category 3D, IP55
453	DIP according to EN 50281-1, category 2D, IP65

Address <http://www.abb.com/motors&drives>

ABB

About ABB Products & Services Sustainability News Center Technology Careers Investor Relations

Motors & Drives
 Go to The ABB Product Guide
 AC Drives >
 AC LV Induction Motors >
 Range of products
 Library of Documents
 Local contact
 Motor availability
 DC Motors >
 Servomotors >
 Power Electronics Systems >
 Motorformer
 Turbochargers
 Contact Us

AC Low Voltage Induction Motors

ABB is offering a market platform of low voltage motors second to none - quality, reliability and performance. Motors for every application - Making you more competitive.

With a broader range of products and services ABB low voltage motors is years ahead of competition. We provide energy efficient, reliable motors with excellent services and options for online ordering via BusinessOnline, a personalized service for ordering motors and drives. Availability is guaranteed by the global central stock concept.

SEARCH

LINKS

- Range of products
- Library of Documents
- Online ordering of motors and drives

Printer version Email this page Bookmark this page

- Motors & Drives**
- AC LV Induction Motors
 - Range of products
 - M3000 Range
 - Standard motors
 - Premium efficiency motors
 - Process motors
 - Hazardous area motors**
 - Marine motors
 - Brake motors
 - Wind turbine generators
 - Roller table motors
 - Single phase motors
 - Fan application motors
 - Water-cooled motors
 - M2000 Range
 - Library of documents
 - Local contact
 - Motor availability

Address <http://www.abb.com/motors&drives>

ABB

About ABB Products & Services Sustainability News Center Technology Careers Investor Relations

Motors & Drives
 Go to The ABB Product Guide
 AC Drives >
 AC LV Induction Motors >
 Range of products
 Library of Documents
 Local contact
 Motor availability
 DC Motors >
 Servomotors >
 Power Electronics Systems >
 Motorformer
 Turbochargers
 Contact Us

M3000 Hazardous Area

M3000 Ex is a complete range of explosion proof motors that fulfill the highest international standards. The motors are designed to meet the high demands for efficiency, performance and availability required by the oil, gas, chemical and petrochemical sectors. The motors also perform extremely well in applications in tanker shipping, petrol stations and hazardous areas in general industry. All M3000 Ex motors are ATEX certified and show efficiency levels equivalent to the highest European standard, EFF1.

Protection categories

- Flameproof EEx d IIB/IC T4, EEx de IIB/IC T4
- Increased safety EEx e II T3
- Non-sparking EEx nA II T3, Ex nA II T3
- Dust ignition protection 'DIP' IP65, IP55 T125°C

Frame sizes From 71 to 400, cast iron and aluminium frames

Rated outputs From 0.25 to 630 kW

Variants from different standards in the oil, gas and chemical sector are available, as well as for marine applications with most classification societies.

SEARCH

CONTACT US

Sales information:
 Please select country -

LINKS

- Range of products
- Library of Documents
- Technical documents - drawings, certificates etc.

Printer version Email this page Bookmark this page

© Copyright 2002 ABB. All rights reserved.

Low Voltage Motors

Manufacturing sites (*) and some of the larger sales companies.

Australia

ABB Industry Pty Ltd
2 Douglas Street
Port Melbourne,
Victoria, 3207
Tel: +61 (0) 3 9644 4100
Fax: +61 (0) 3 9646 9362

Austria

ABB AG
Wienerbergstrasse 11 B
A-1810 Wien
Tel: +43 (0) 1 601 090
Fax: +43 (0) 1 601 09 8305

Belgium

Asea Brown Boveri S.A.-N.V.
Hoge Wei 27
B-1930 Zaventem
Tel: +32 (0) 2 718 6311
Fax: +32 (0) 2 718 6657

Brazil

Asea Brown Boveri Ltda
P.O.Box 00975
06020-902 Osasco -SP
Tel: +55 (0) 11 7088 9526
Fax: +55 (0) 11 7088 4523

Canada

ABB Inc., BAElectrical Machines
10300 Henri-Bourassa Blvd,
West, Saint-Laurent, Quebec
Canada H4S 1N6
Tel: +1 514 832-6583
Fax: +1 514 332-0609

China*

ABB Yuejin Motors (Shanghai)
Company Limited
8 Guang Xing Rd., Rong Bei
Town, Songjiang County,
Shanghai 201613
Tel: +86 21 5778 0988
Fax: +86 21 5778 1364

Chile

Asea Brown Boveri S.A.
P.O.Box 581-3
Santiago
Tel: +56 (0) 2 5447 100
Fax: +56 (0) 2 5447 405

Denmark

ABB A/S
Automation Technology Electrical
Machines
Petersmindevej 1
DK-5000 Odense C
Tel: +45 65 477 070
Fax: +45 65 477 713

Finland*

ABB Oy
LV Motors
P.O.Box 633
FIN-65101 Vaasa
Tel: +358 (0) 10 22 11
Fax: +358 (0) 10 22 47372

France

ABB Automation
Rue du Général de Gaulle
Champagne-sur-Seine
F-77811 Moret-sur-Loing Cedex
Tel: +33 (0) 1 60 746 500
Fax: +33 (0) 1 60 746 565

Germany

ABB Automation Products
GmbH
P.O.Box 10 02 61
D-68002 Mannheim
Tel: +49 (0) 621 3810
Fax: +49 (0) 621 381 6820

Hong Kong

ABB Automation Limited
3 Dai Hei Street
Tai Po Industrial Estate
Tai Po New Territories
Hong Kong
Tel: +852 292 938 38
Fax: +852 292 938 87

India*

Asea Brown Boveri Ltd
P.O.Box 16
Faridabad 121 001
Tel: +91 (0) 882 3001
Fax: +91 (0) 882 3006

Indonesia

P.T. Abdibangun Buana
P.O.Box 3781
Jakarta 10002
Tel: +62 (0) 21 314 9115
Fax: +62 (0) 21 315 3963

Ireland

Asea Brown Boveri Ltd
Components Division
Belgard Road
Tallaght, Dublin 24
Tel: +353 (0) 1 405 7300
Fax: +353 (0) 1 405 7327

Italy*

ABB Industria SpA
BAU LV Motors
Via Della Meccanica, 22
I-20040 Caponago - MI
Tel: +39 02 959 6671
Fax: +39 02 959 667216

Japan

ABB K.K.
26-1 Cerulean Tower
Sakuragaoka-cho, Shibuya-ku
Tokyo 150-8512
Tel: +81 (0) 3 578 46251
Fax: +81 (0) 3 578 46260

Korea

ABB Korea Ltd.
7-9fl, Oksan Bldg., 157-33
Sungshung-dong, Kangnam-ku
Seoul
Tel: +82 2 528 2329
Fax: +82 2 528 2338

Mexico

ABB México, S.A. de C.V.
Apartado Postal 111
CP 54000 Tlalnepantla
Edo. de México, México
Tel: +52 5 328 1400
Fax: +52 5 390 3720

The Netherlands

ABB B.V.
Dept. LV motors (APP2R)
P.O.Box 301
NL-3000 AH Rotterdam
Tel: +31 (0) 10 4078 879
Fax: +31 (0) 10 4078 345

New Zealand

ABB Automation
Motor Sales
P.O.Box 22167
Otahuhu, Auckland
Tel: +64 (0) 9 276 6016
Fax: +64 (0) 9 276 1303

Norway

ABB AS
Automation Technology Products
Division
P.O.Box 6540 Rodeloekka
N-0501 Oslo 5
Tel: +47 22 872 000
Fax: +47 22 872 541

Singapore

ABB Industry Pte Ltd
P.O.Box 95
Pasir Panjang Post Office
Singapore 9111
Tel: +65 775 3777
Fax: +65 778 0222

Spain*

ABB Automation Products S.A.
Division Motores
P.O.Box 81
E-08200 Sabadell
Tel: +34 93 728 8500
Fax: +34 93 728 8741

Sweden*

ABB Automation Technology
Products AB
Motors & Machines
LV Motors
S-721 70 Västerås
Tel: +46 (0) 21 329 000
Fax: +46 (0) 21 124 103

Switzerland

ABB Switzerland Ltd
Normelec/CMC Components
Motors&Drives
Badenerstrasse 790
Postfach
CH-8048 Zürich
Tel: +41 (0) 58 586 0666
Fax: +41 (0) 58 586 0603

Taiwan

Asea Brown Boveri Ltd
P.O.Box 81-54
Taipei
Tel: +886 (0) 2 579 9340
Fax: +886 (0) 2 577 9434

Thailand

ABB Limited
5th Building, 322 Moo 4
Bangpoo Industrial Estate Soi 6
Sukhumvit Road, Prekasa,
Muang, Samutprakarn 10280
Tel: +662 (0) 709 3346
Fax: +662 (0) 709 3765

The United Kingdom

ABB Automation Ltd
9 The Towers, Wilmslow Road
Didsbury
Manchester, M20 2AB
Tel: +44 (0) 161 445 5555
Fax: +44 (0) 161 448 1016

USA

ABB Inc.
Electrical Machines
P.O.Box 372
Milwaukee
WI 53201-0372
Tel: +1 262 785 3200
Fax: +1 262 785 8628

Venezuela

Asea Brown Boveri S.A.
P.O.Box 6649
Carmelitas,
Caracas 1010A
Tel: +58 (0) 2 238 2422
Fax: +58 (0) 2 239 6383



<http://www.abb.com/motors&drives>
<http://online.abb.com/motors&drives>